

All kinds of Dental instruments .

WE ARE MANUFACTURERS AND EXPORTERS

 **URIYA Instruments®**

Adequately equipped to meet the ever growing demands of its leading foreign client . In order to continue to achieve our vision we are continually working for development of new products and has provided manufacturing services for innovations in the field of medical industry. As our skillful technicians put their best efforts into the latest production processes of each and every product.

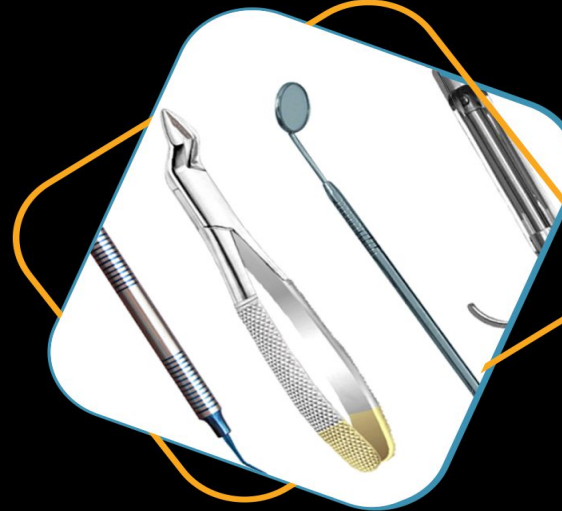

Mobile # +61 402 764 684 / +923126505109

Web : www.uriyainstruments.com

E-mail : uriyahinstruments@gmail.com

: info@uriyainstruments.com

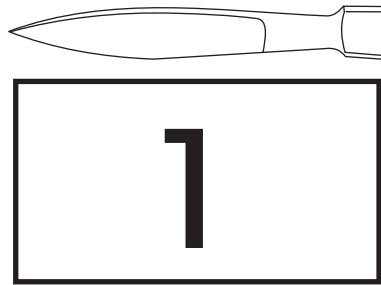

Scalpel

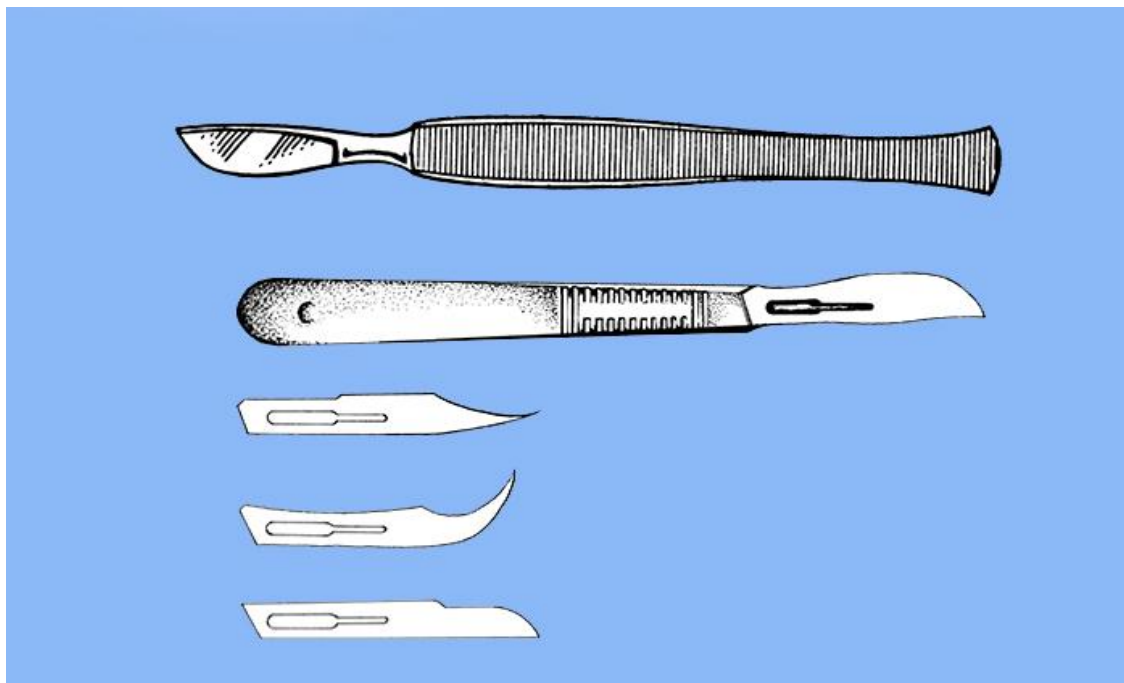

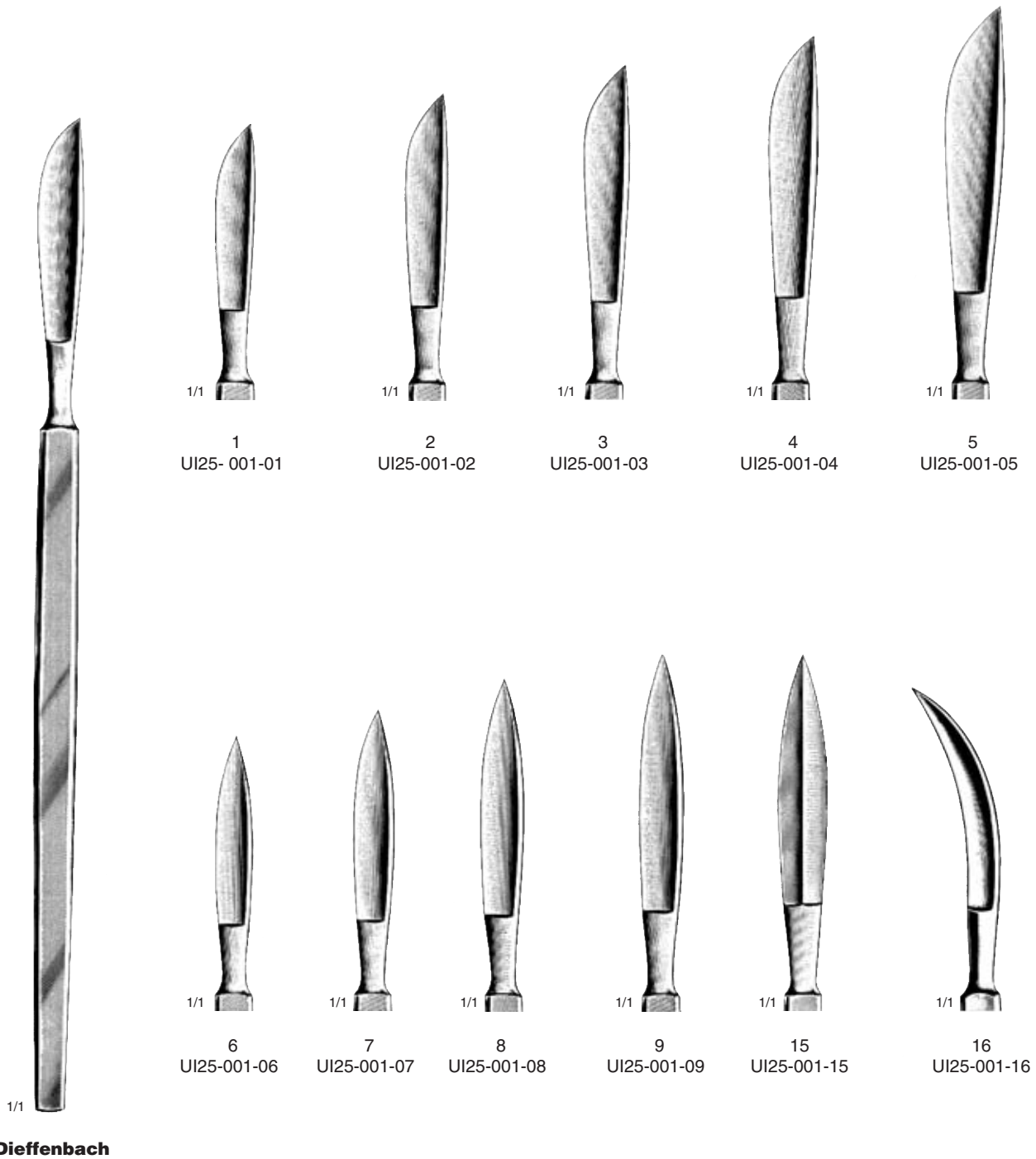
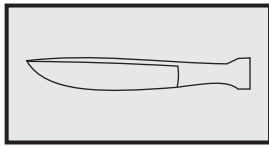

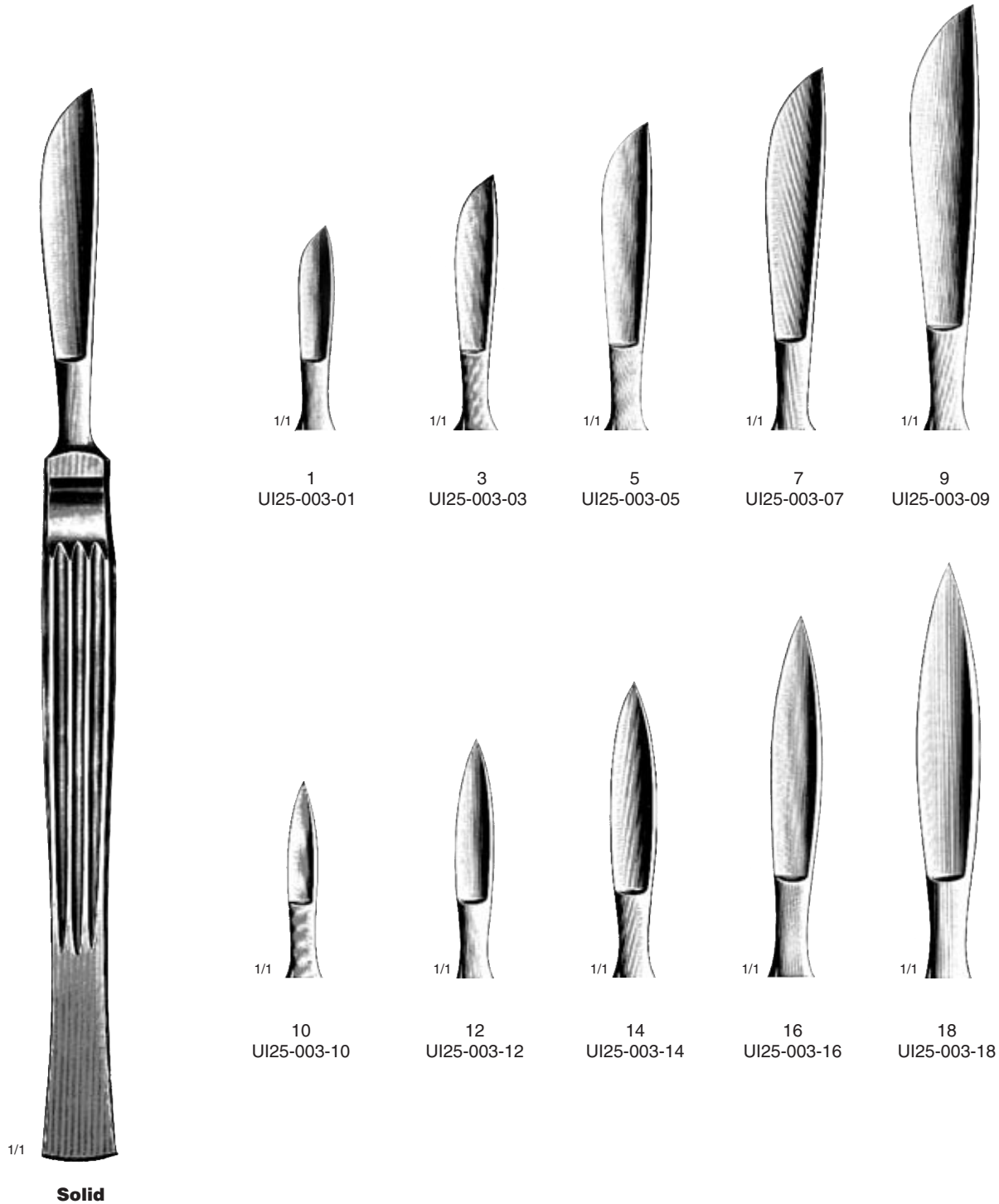
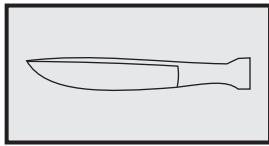

UI25-003-01 UI25-003-64 Knives with Solid Handle

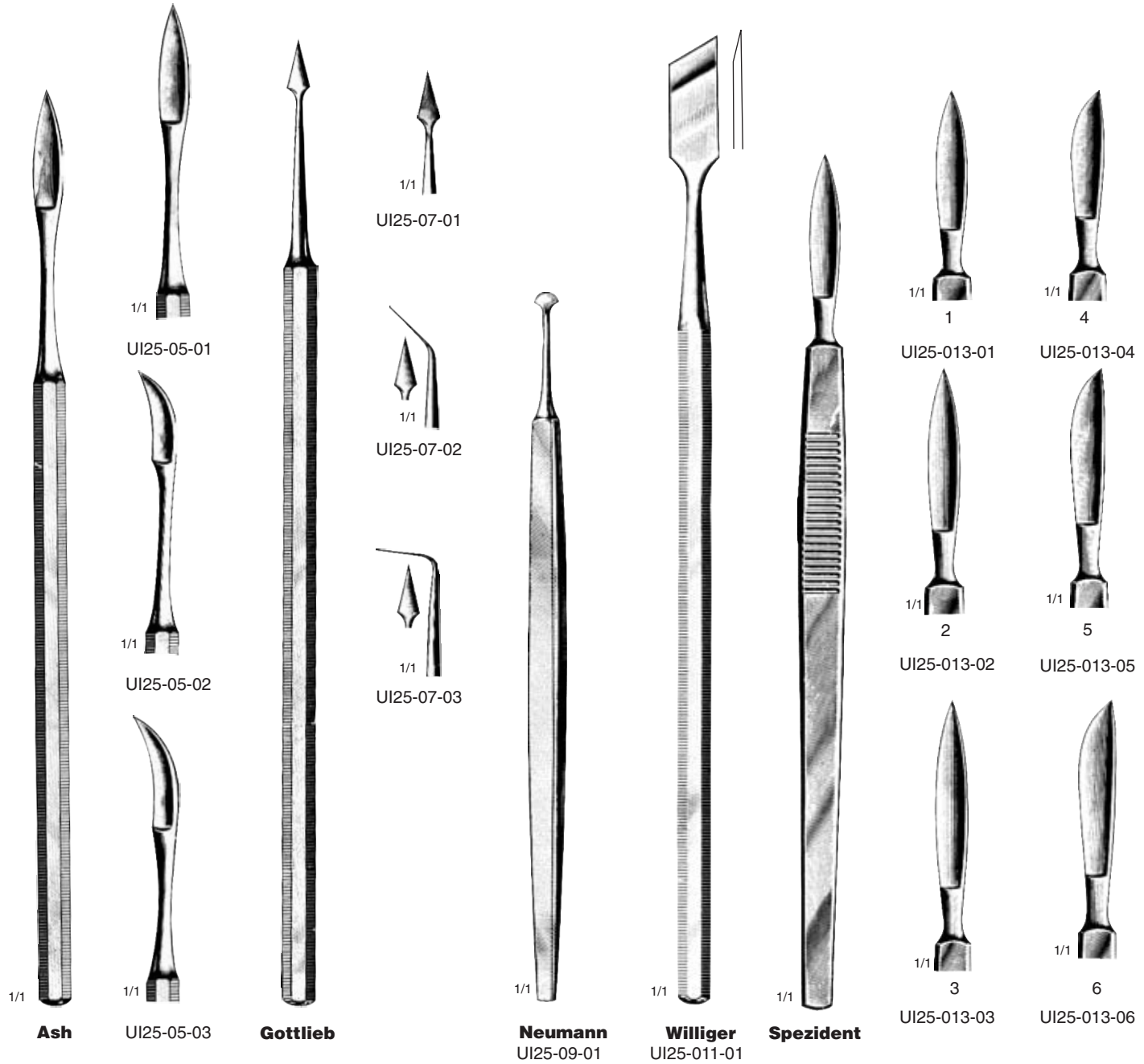
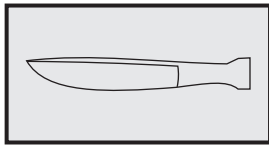

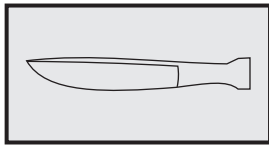

1/1

Solid No.3
UI25-015-03



1/1

Solid No.3
UI25-017-03



1/1

Solid No.4
UI25-019-04



1/1

Solid No.4-3
UI25-021-43



1/1

Solid No.7
UI25-023-07



1/1

Solid No.7K
UI25-025-07

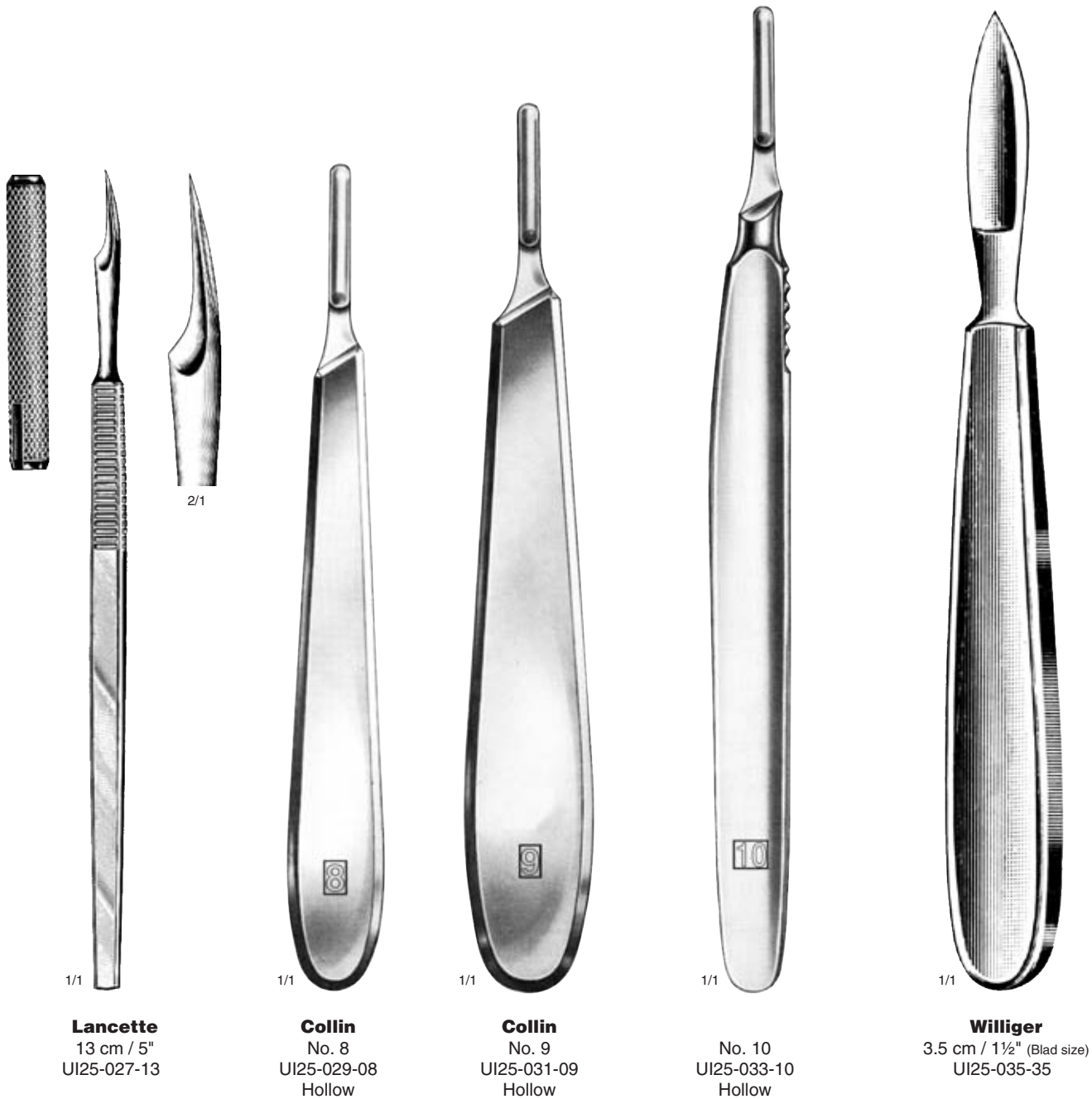
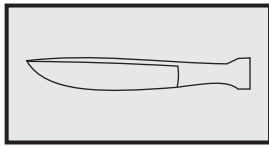

Lancette
13 cm / 5"
UI25-027-13

Collin
No. 8
UI25-029-08
Hollow

Collin
No. 9
UI25-031-09
Hollow

No. 10
UI25-033-10
Hollow

Williger
3.5 cm / 1½" (Blad size)
UI25-035-35



Scissors

 URIYA Instruments®



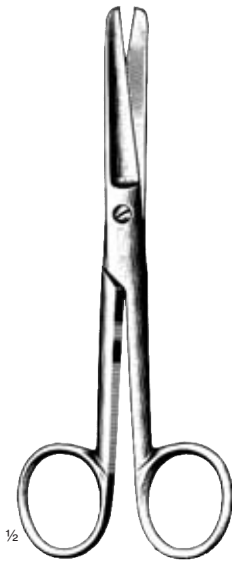
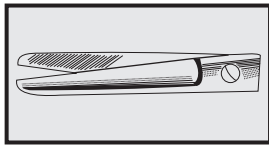

Standard

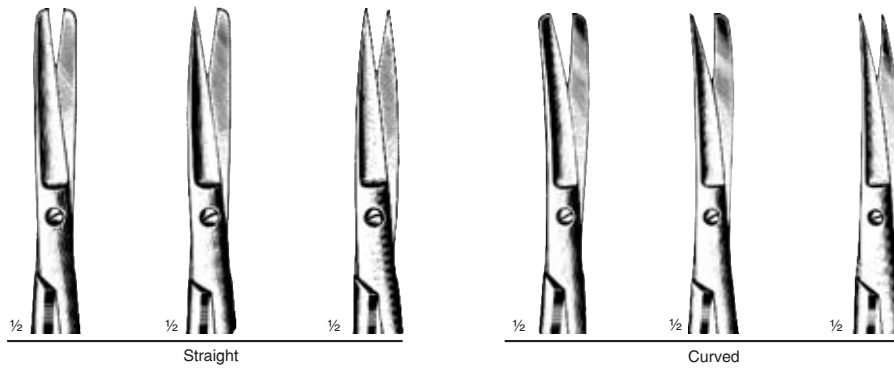

cm	in	UI26-001-10	UI26-003-10	UI26-005-10	UI26-007-10	UI26-009-10	UI26-011-10
10.5	4¼	UI26-001-10	UI26-003-10	UI26-005-10	UI26-007-10	UI26-009-10	UI26-011-10
11.5	4½	UI26-001-11	UI26-003-11	UI26-005-11	UI26-007-11	UI26-009-11	UI26-011-11
13	5	UI26-001-13	UI26-003-13	UI26-005-13	UI26-007-13	UI26-009-13	UI26-011-13
14.5	5½	UI26-001-14	UI26-003-14	UI26-005-14	UI26-007-14	UI26-009-14	UI26-011-14
15.5	6	UI26-001-15	UI26-003-15	UI26-005-15	UI26-007-15	UI26-009-15	UI26-011-15
16.5	6½	UI26-001-16	UI26-003-16	UI26-005-16	UI26-007-16	UI26-009-16	UI26-011-16



Graziil

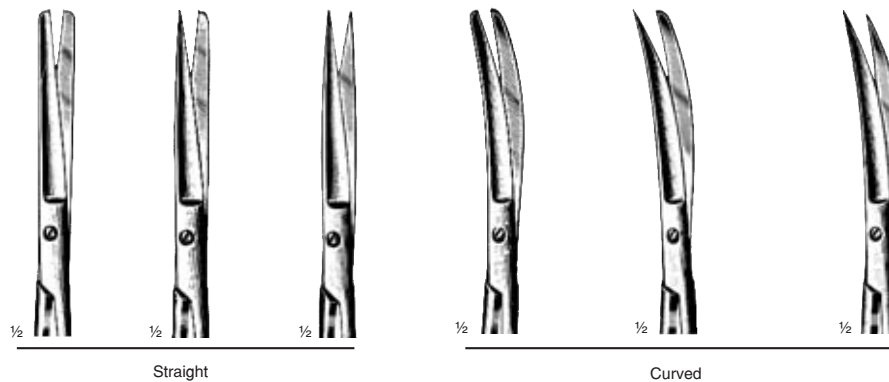

cm	in	UI26-013-13	UI26-015-13	UI26-017-13	UI26-019-13	UI26-021-13	UI26-023-13
13	5	UI26-013-13	UI26-015-13	UI26-017-13	UI26-019-13	UI26-021-13	UI26-023-13
14.5	5½	UI26-013-14	UI26-015-14	UI26-017-14	UI26-019-14	UI26-021-14	UI26-023-14

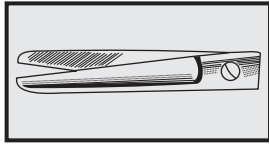

1/2

Metzenbaum
14.5 cm / 5 1/2"

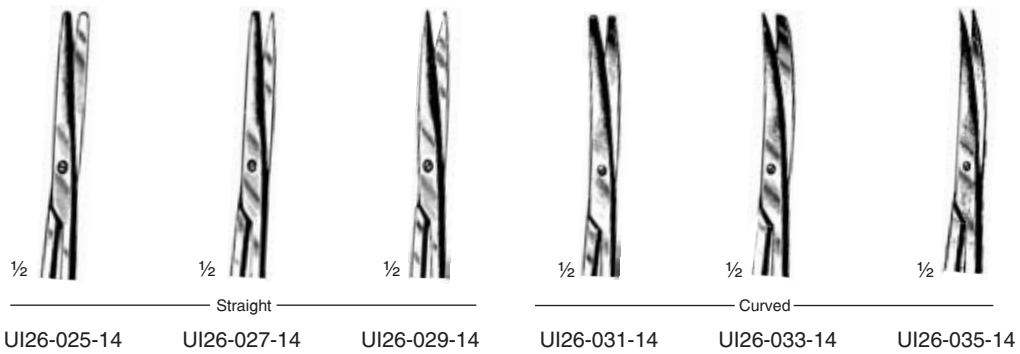

1/2

Metzenbaum-Nelson
18 cm / 7"

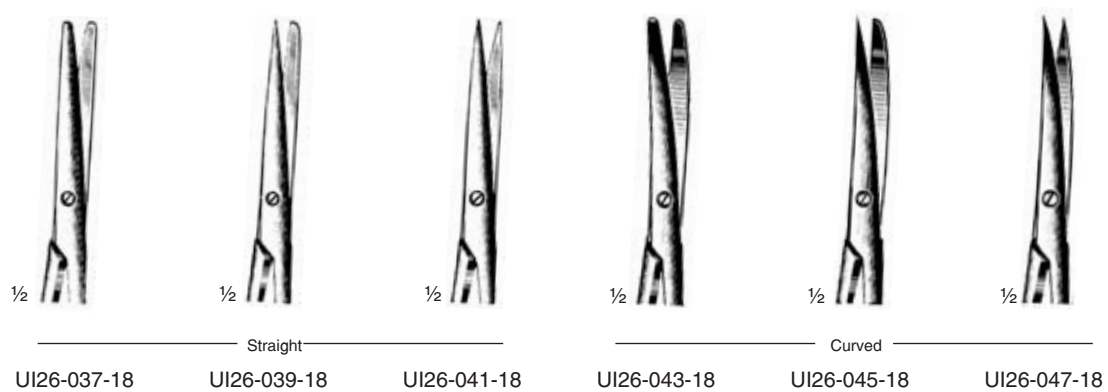

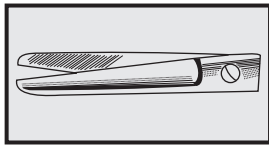

Kelly
16 cm / 6½"
UI26-049-16



Prince
18 cm / 7"
AE 02-051-18

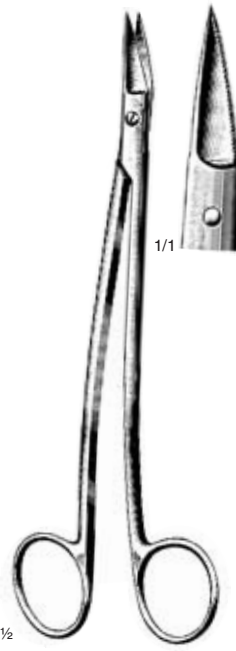

Dean
17 cm / 6¾"
UI26-053-17



12 cm / 4¾"



UI26-055-12



UI26-057-12



UI26-059-12



UI26-061-12

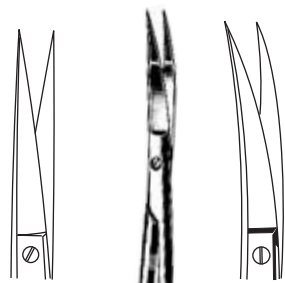

13 cm / 5"
UI26-065-13

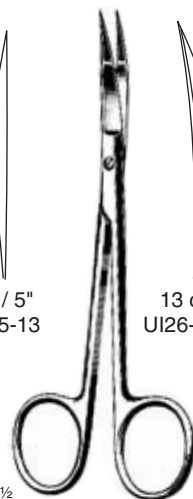

Wagner
13 cm / 5"



13 cm / 5"
UI26-067-13



12 cm / 4¾"
UI26-069-12

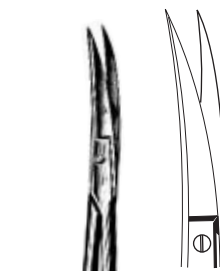

12 cm / 4¾"
UI26-071-12

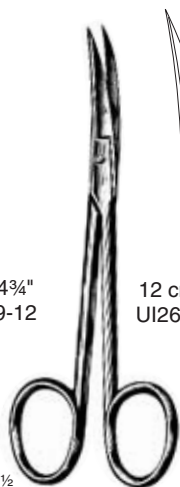

Wagner
12 cm / 4¾"



11.5 cm / 4½"
UI26-075-11
Curved

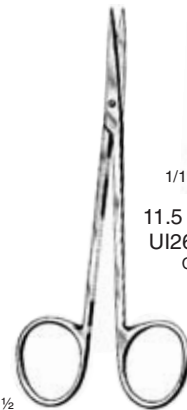

11.5 cm / 4½"
UI26-073-11
Straight

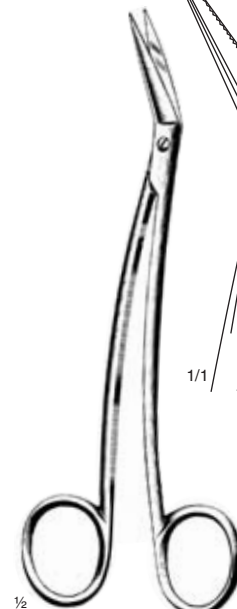
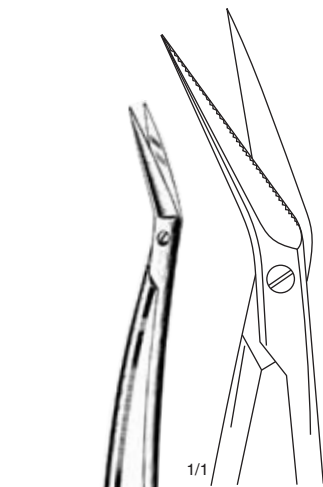

Locklin
16 cm / 6¼"
UI26-077-16
Saw edge

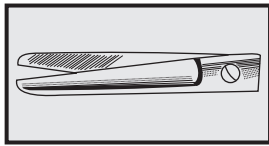

cm	in	Straight	Curved	Straight	Curved	Straight	Curved
9	3½			UI26-083-09	UI26-085-09		
10	4			UI26-083-10	UI26-085-10		
11	4½	UI26-079-11	UI26-081-11	UI26-083-11	UI26-085-11	UI26-087-11	UI26-089-11
11.5	4½						

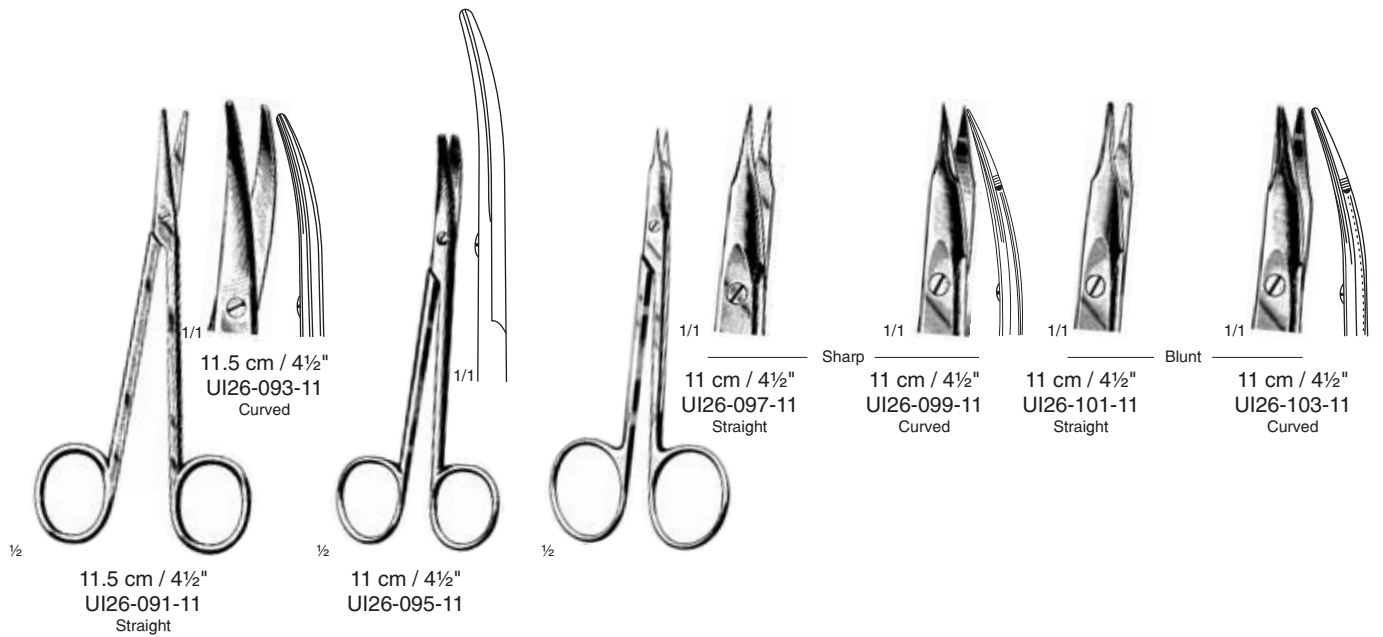

UI26-083-09 UI26-089-11 Iris Scissors

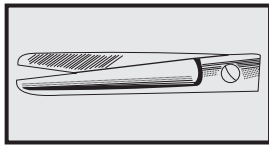

1/2
13 cm / 5"
UI26-105-13



1/2
Spencer
9 cm / 3 1/2"
UI26-107-09



1/2
Spencer
13 cm / 5"
UI26-109-13



1/2
Buck
14.5 cm / 5 1/2"
UI26-111-14
18 cm / 7"
UI26-111-18



1/2
12 cm / 4 3/4"
UI26-113-12



1/2
Littauer
14 cm / 5 1/2"
UI26-115-14

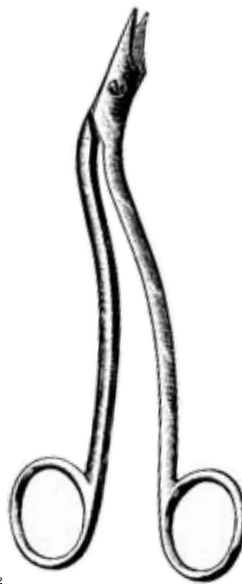

1/2
Heath
15 cm / 6"
UI26-117-15



1/2
Shoemaker-Loth
13 cm / 5"
UI26-119-13



1/2
Eiselsberg
12 cm / 4 3/4"
UI26-121-12

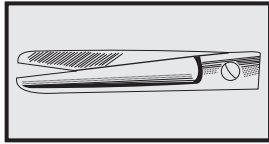

Universal
12 cm / 4 3/4"
UI26-123-12
Saw edge

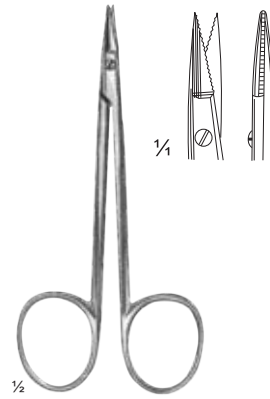

10 cm / 4"
UI26-125-10
Saw edge

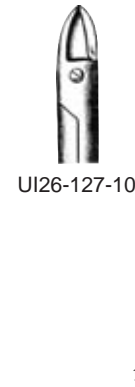

UI26-127-10

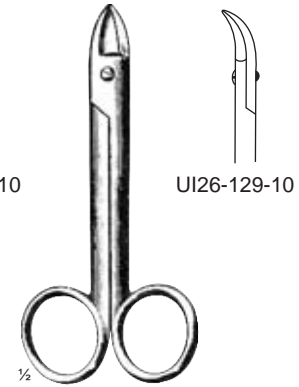

UI26-129-10

Beebee
10 cm / 4"
Blunt

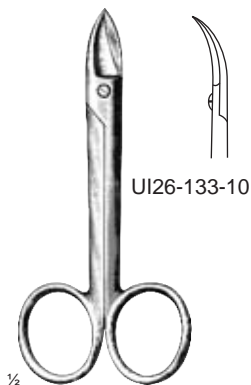

UI26-133-10

Beebee
10 cm / 4"
UI26-131-10
Sharp

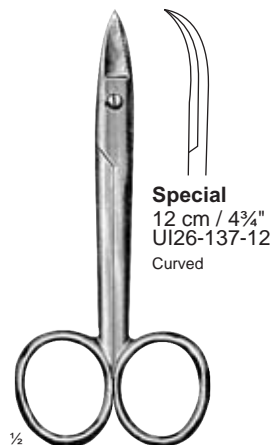

Special
12 cm / 4 3/4"
UI26-137-12
Curved

Special
12 cm / 4 3/4"
UI26-135-12
Saw edge

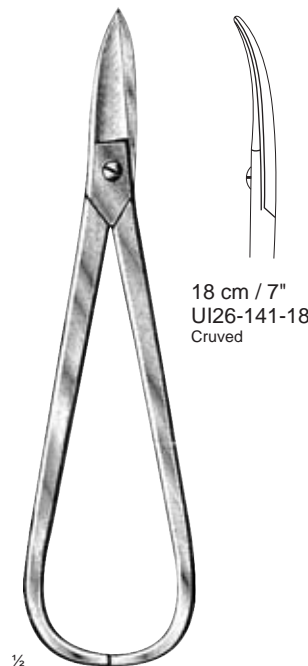

18 cm / 7"
UI26-141-18
Curved

18 cm / 7"
UI26-139-18
Straight

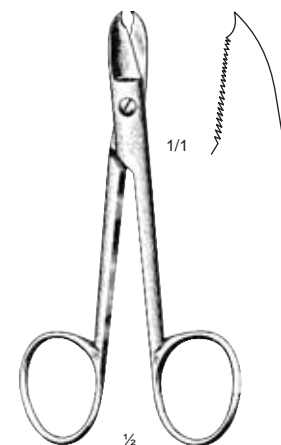

12 cm / 4 3/4"
UI26-143-12
Saw edge

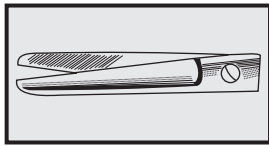

10.5 cm / 4"
UI26-145-10
Saw edge

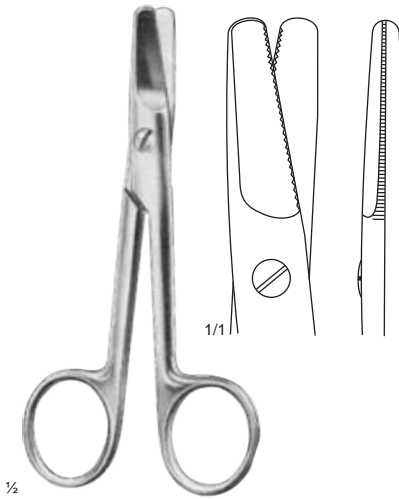

Harvey
12.5 cm / 5"
UI26-147-12

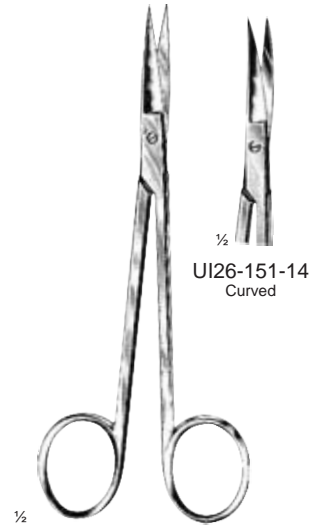

Sanvenero
14 cm / 5½"
UI26-149-14
Straight

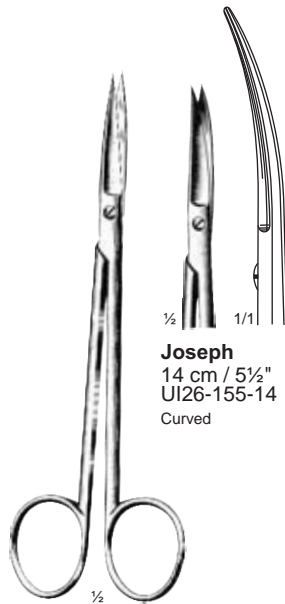

Joseph
14 cm / 5½"
UI26-155-14
Curved



Lexer
16cm/6 ¼"
UI26-157-16
21cm/8 ½"
UI26-159-21

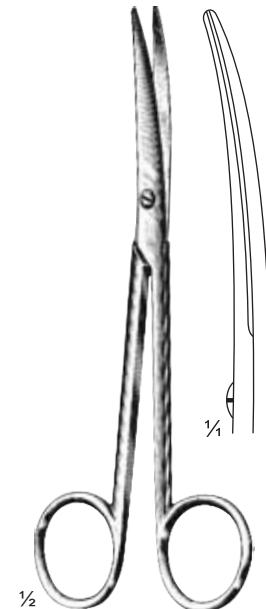

Lexer
16cm/6 ¼"
UI26-161-16
21cm/8 ½"
UI26-163-21

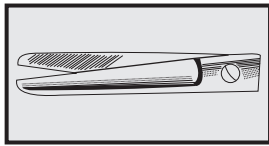

½

Metzenbaum
14.5 cm / 5½"
UI26-165-14
saw edge, straight



½

Metzenbaum
14.5 cm / 5½"
UI26-167-14
saw edge, curved

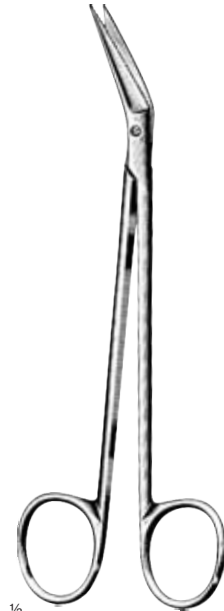

½

Locklin
16 cm / 6¼"
UI26-173-16
saw edge

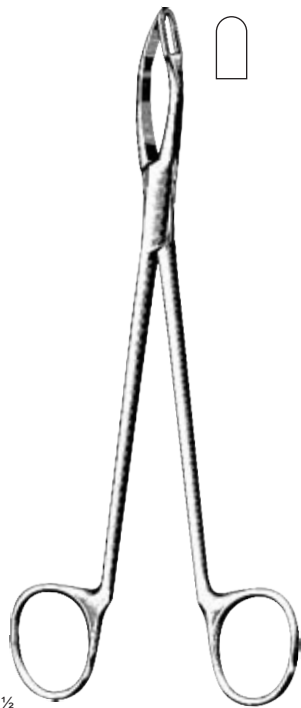

½

Modell USA
18 cm / 7"
UI26-175-18

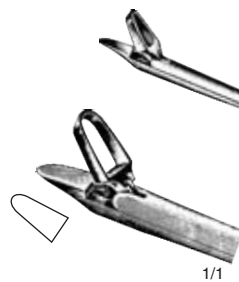

1/1



½

Tomati
19 cm / 7½"
UI26-177-19

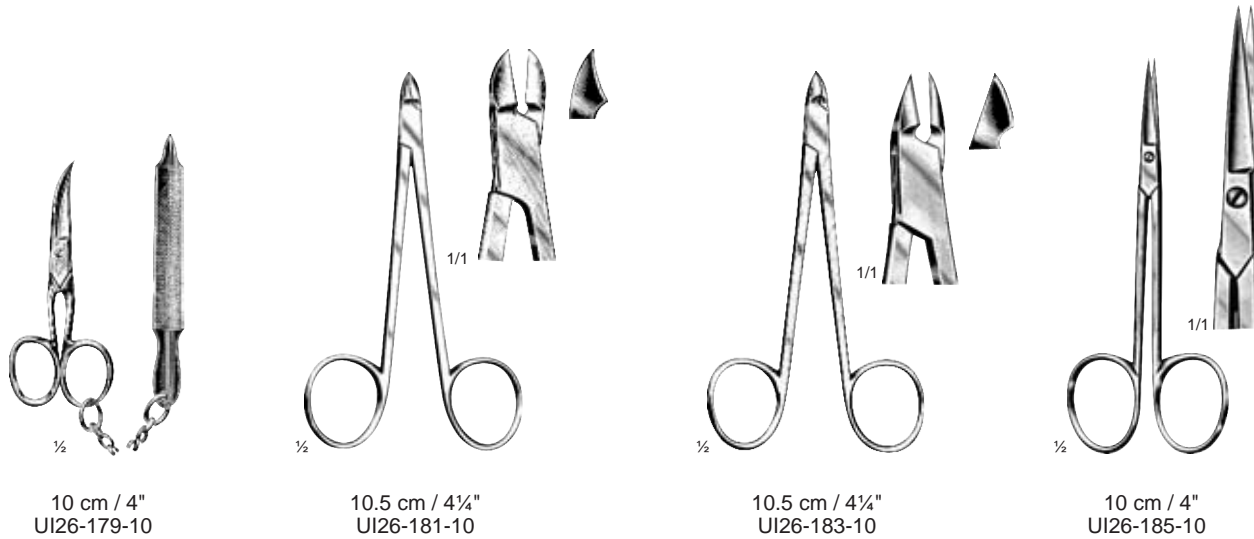
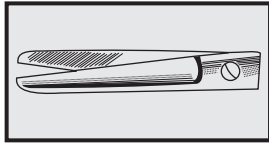

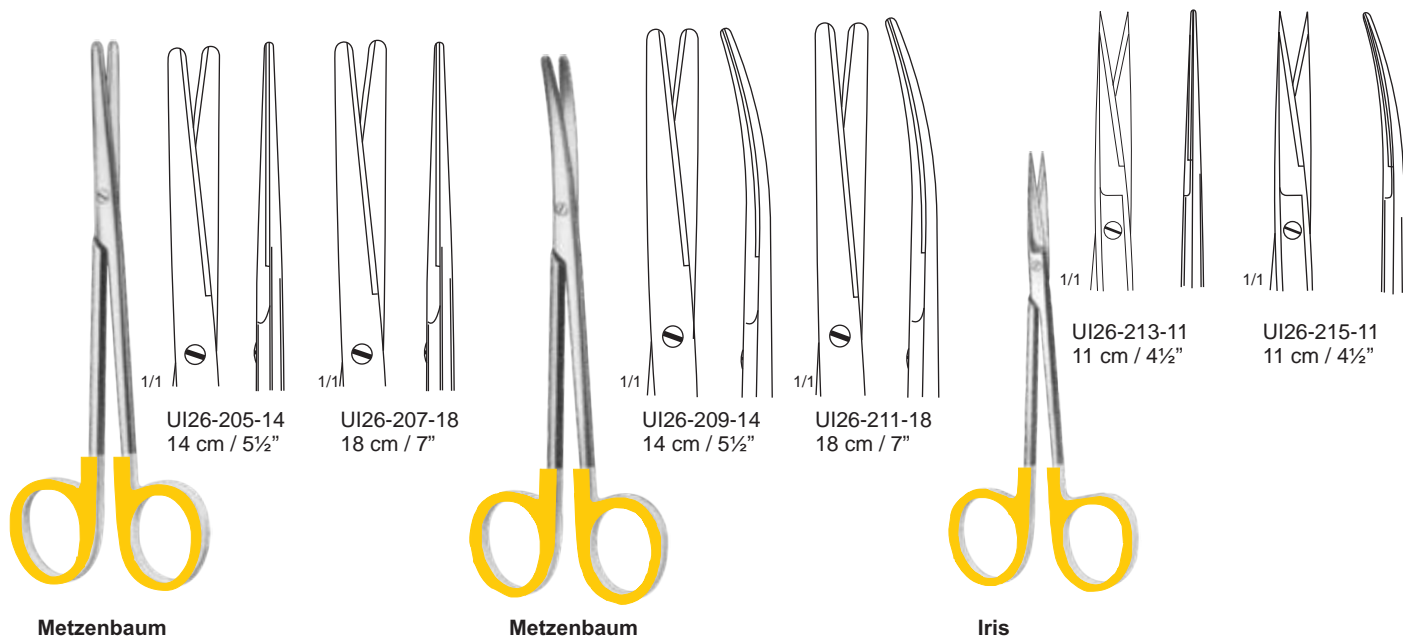
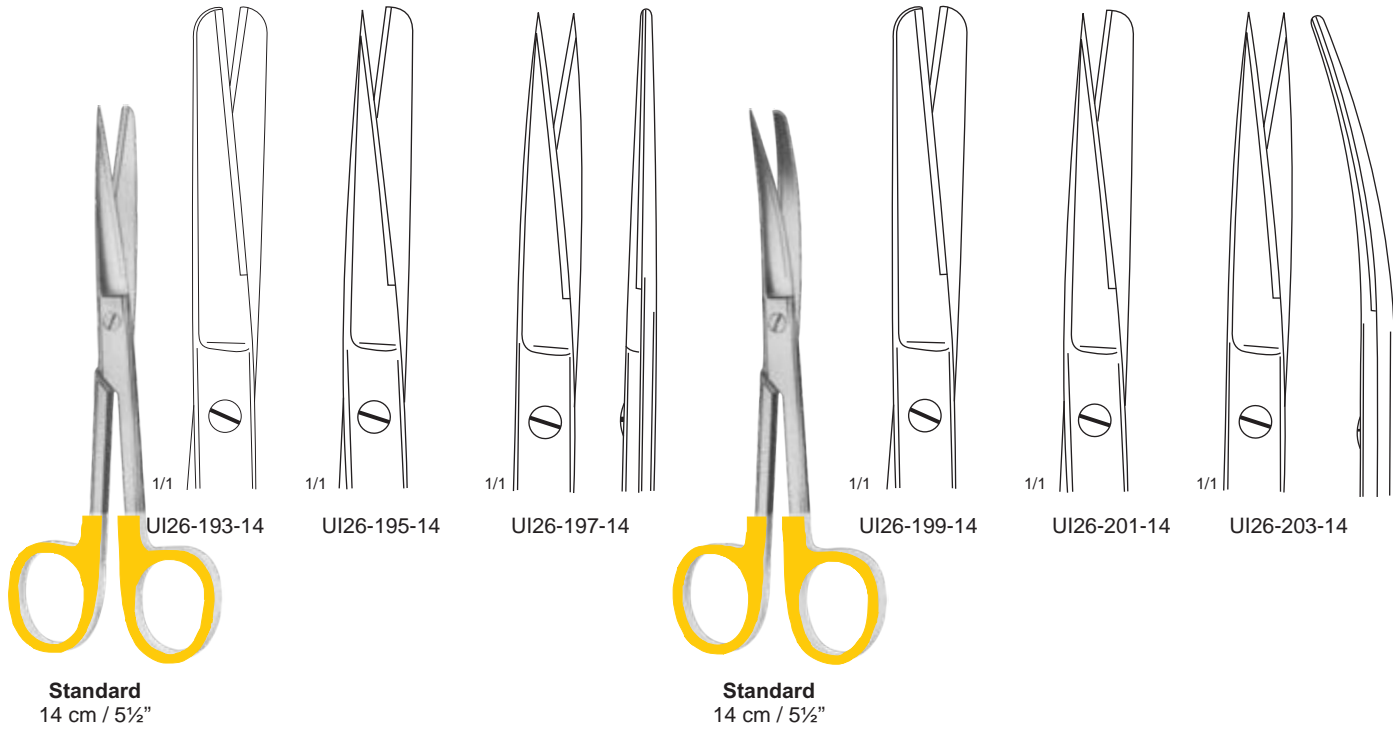
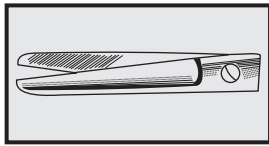

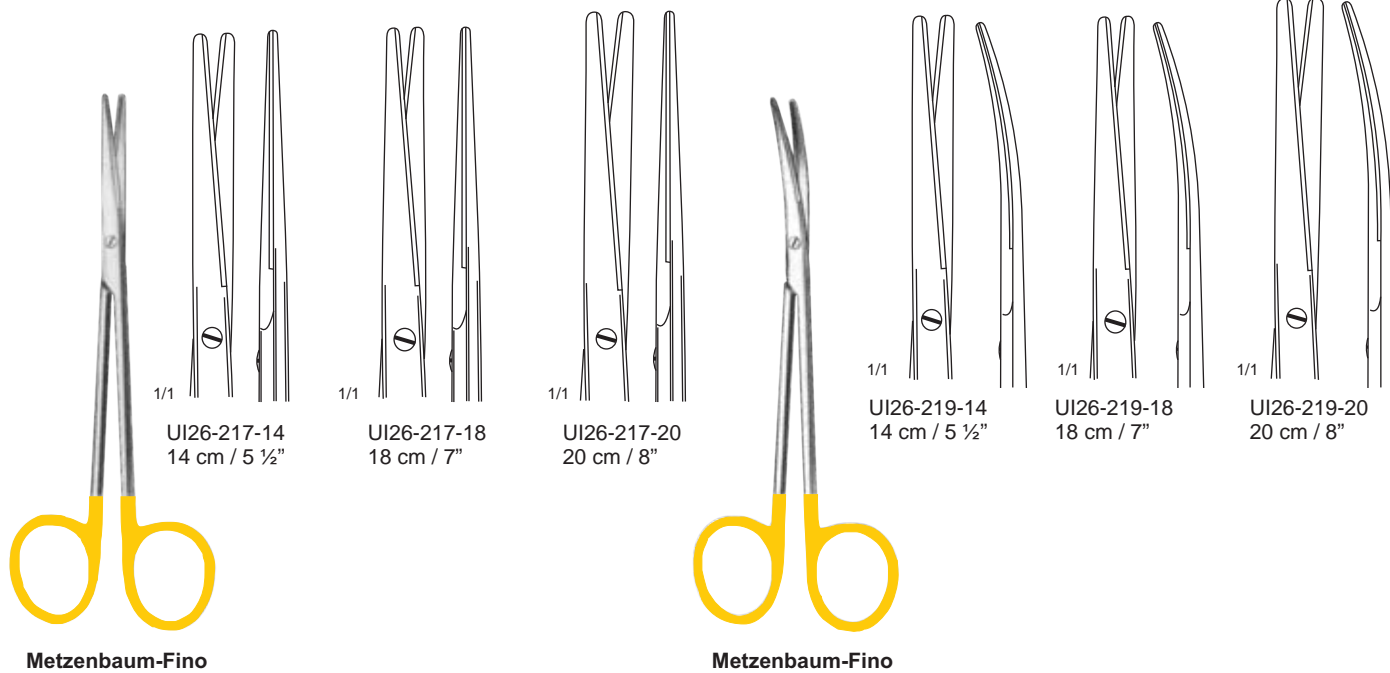
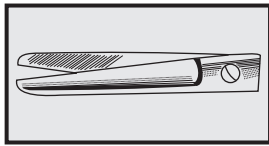

Metzenbaum-Fino

Metzenbaum-Fino

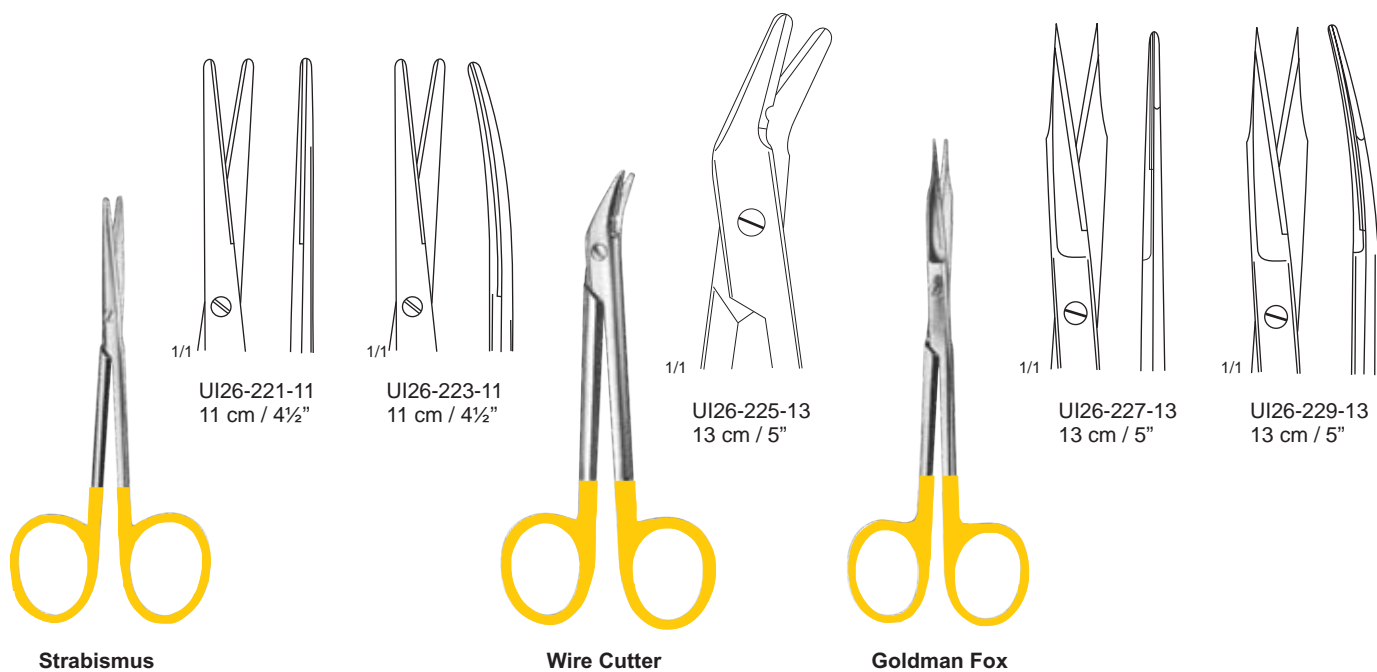

Strabismus

Wire Cutter

Goldman Fox

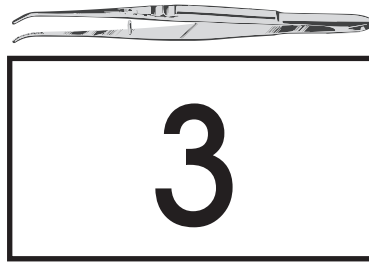

Dressing Forceps

 URIYA Instruments®



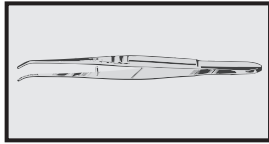

cm	in.	Standard	Standard	Standard	Standard	USA. Mod.	USA. Mod.
10.5	4¼	UI27-001-10	UI27-003-10	UI27-005-10	UI27-007-10		
14.5	5½	UI27-001-14	UI27-003-14	UI27-005-14	UI27-007-14	UI27-009-14	UI27-011-14
16	6½	UI27-001-16	UI27-003-16	UI27-005-16	UI27-007-16		
18	7	UI27-001-18	UI27-003-18	UI27-005-18	UI27-007-18	UI27-009-18	UI27-011-18

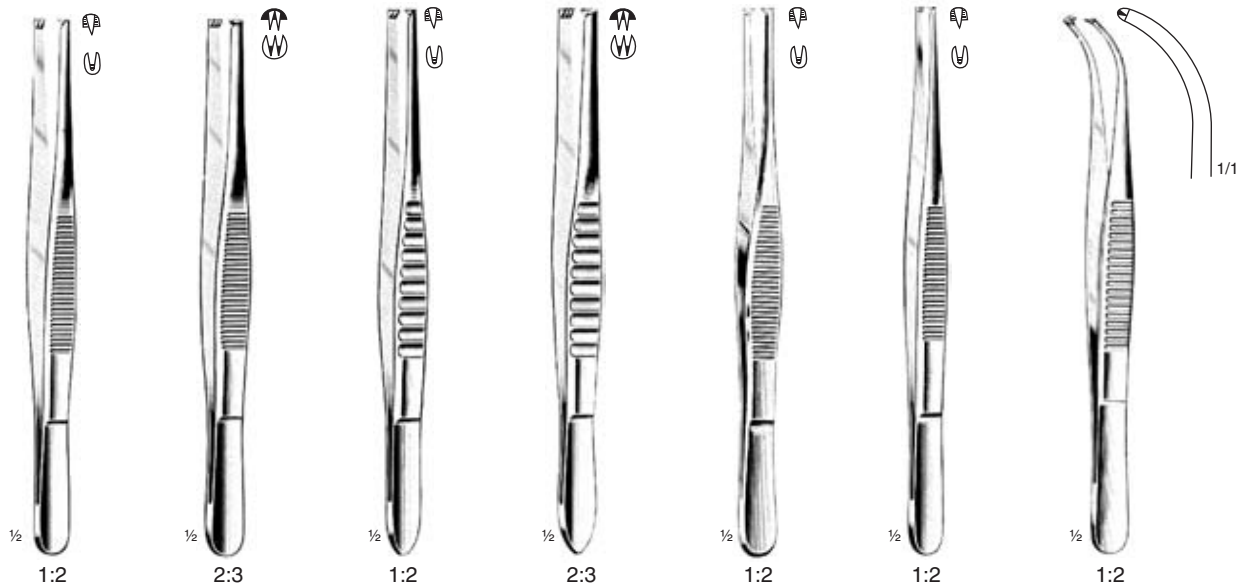

cm	in.	1:2	2:3	1:2	2:3	1:2	1:2	1:2
11	4½	UI27-013-11	UI27-015-11					
14	6	UI27-013-14	UI27-015-14	UI27-017-14	UI27-019-14	UI27-021-14	UI27-023-14	UI27-025-14
16	7	UI27-013-16	UI27-015-16					
18	8	UI27-013-18	UI27-015-18	UI27-017-18	UI27-019-18			

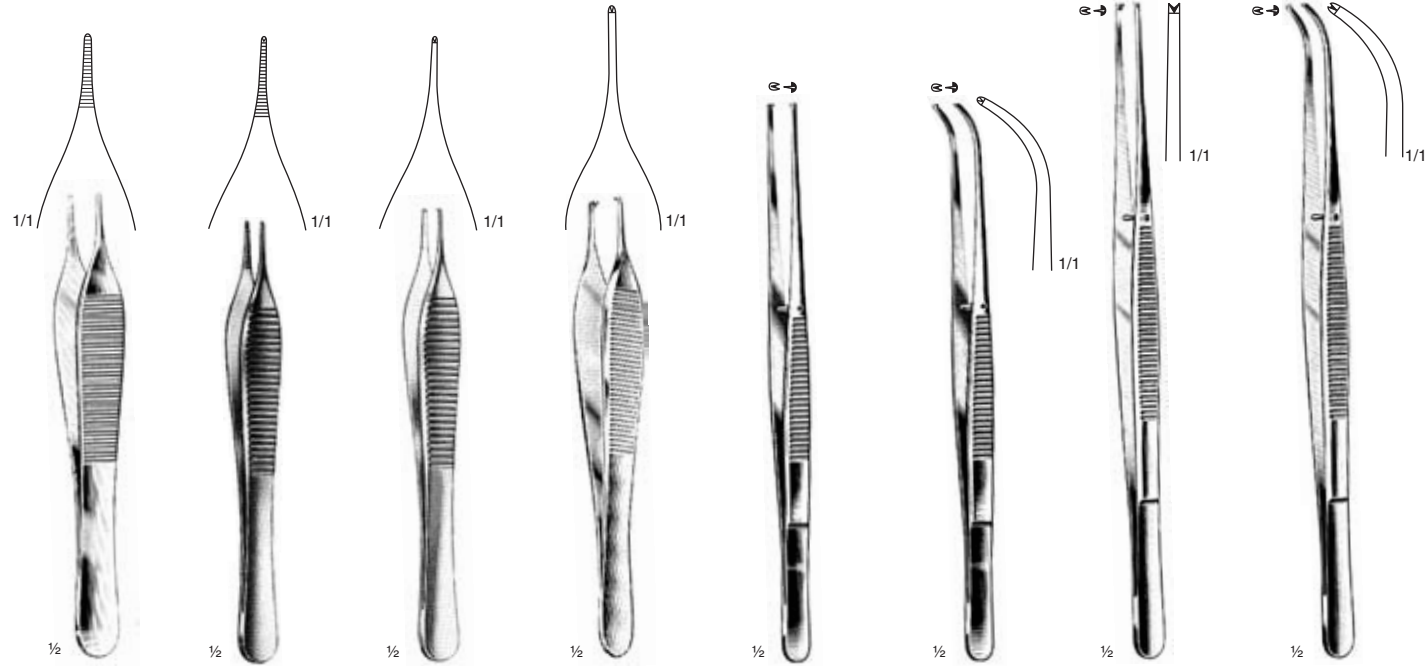
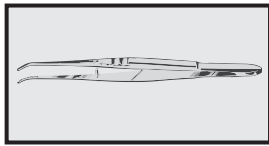

Adson
12 cm / 4¾"
UI27-026-12

Micro-Adson
12 cm / 4¾"
UI27-027-12

Micro-Adson
12 cm / 4¾"
UI27-029-12
1:2

Adson
12 cm / 4¾"
UI27-031-12
15 cm / 6"
UI27-031-15
1:2

Semken
12.5 cm / 5"
UI27-033-12
15 cm / 6"
UI27-033-15
1:2

Semken
12.5 cm / 5"
UI27-035-12
15 cm / 6"
UI27-035-15
1:2

Taylor
17.5 cm / 7"
UI27-037-17
1:2

Taylor
17.5 cm / 7"
UI27-039-17
1:2



Taylor
17.5 cm / 7"
UI27-041-17
1:2



Semken
12.5 cm / 5"
UI27-043-12
15.5 cm / 6"
UI27-043-15



Semken
12.5 cm / 5"
UI27-045-12
15.5 cm / 6"
UI27-045-15



Potts-smith
18 cm / 7"
UI27-047-18
21 cm / 8¼"
UI27-047-21



Potts-smith
18 cm / 7"
UI27-049-18
21 cm / 8¼"
UI27-049-21



Adson-Brown
12 cm / 4¾"
UI27-051-12

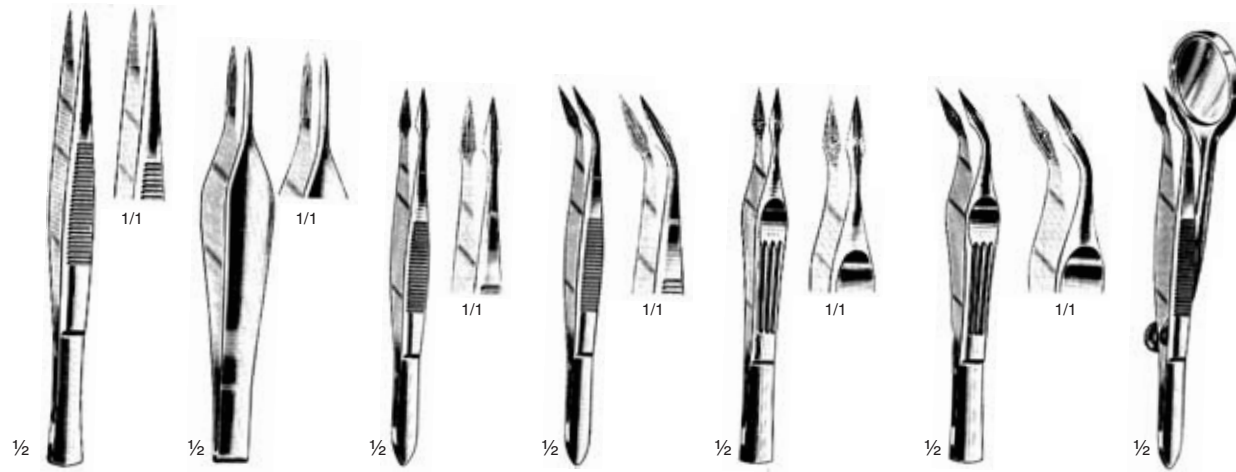
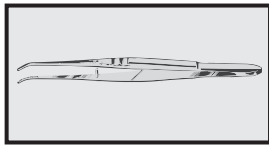

	Feilchenfeld		Hunter		Walter-Carmalt	
12.5cm / 4¾"	7.5cm / 3"	10.5cm / 4¼"	10.5cm / 4¼"	10.5cm / 4¼"	10.5cm / 4¼"	12.5cm / 4¾"
UI27-053-12	UI27-055-07 9cm / 3½"	UI27-057-10	UI27-0759-10	UI27-061-10	UI27-063-10	UI27-065-12
	UI27-055-09					



Smooth	Smooth	Smooth	Smooth	Smooth	Smooth	Smooth	Smooth
W/Out With Pin	With Pin	W/Out With Pin	With Pin	W/Out With Pin	With Pin	W/Out With Pin	With Pin

cm	in								
8	3¼	UI27-067-08	UI27-069-08	UI27-071-08	UI27-073-08	UI27-075-08	UI27-077-08	UI27-079-08	UI27-081-08
9	3½	UI27-067-09	UI27-069-09	UI27-071-09	UI27-073-09	UI27-075-09	UI27-077-09	UI27-079-09	UI27-081-09
10.5	4¼	UI27-067-10	UI27-069-10	UI27-071-10	UI27-073-10	UI27-075-11	UI27-077-10	UI27-079-10	UI27-081-10
11.5	4½	UI27-067-11	UI27-069-11	UI27-071-11	UI27-073-11	UI27-075-12	UI27-077-11	UI27-079-11	UI27-081-11
12.5	5	UI27-067-12	UI27-069-12	UI27-071-12	UI27-073-12		UI27-077-12	UI27-079-12	UI27-081-12

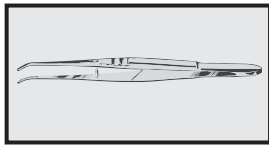

2/3

London Collage
15 cm / 6"

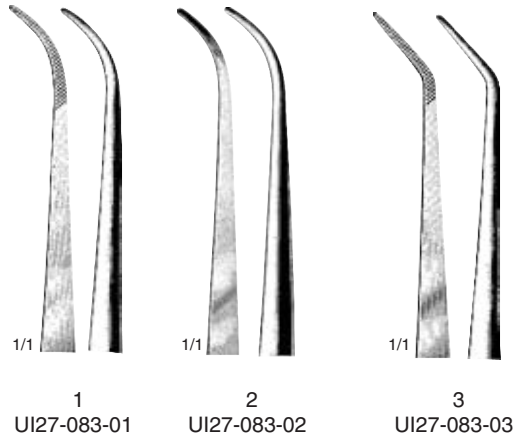

1/1

1

UI27-083-01

1/1

2

UI27-083-02

1/1

3

UI27-083-03

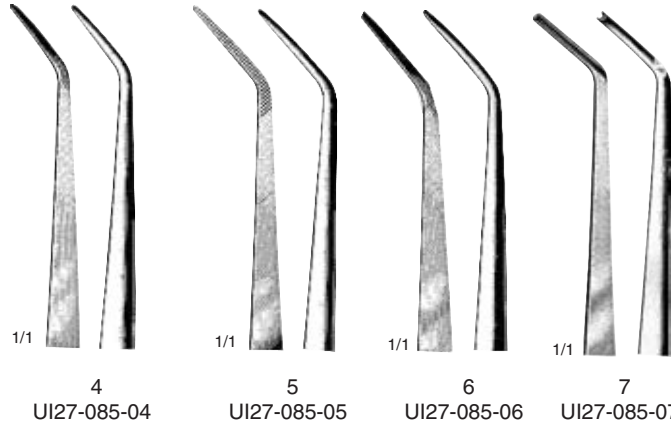

1/1

4

UI27-085-04

1/1

5

UI27-085-05

1/1

6

UI27-085-06

1/1

7

UI27-085-07



2/3

London Collage
15 cm / 6"

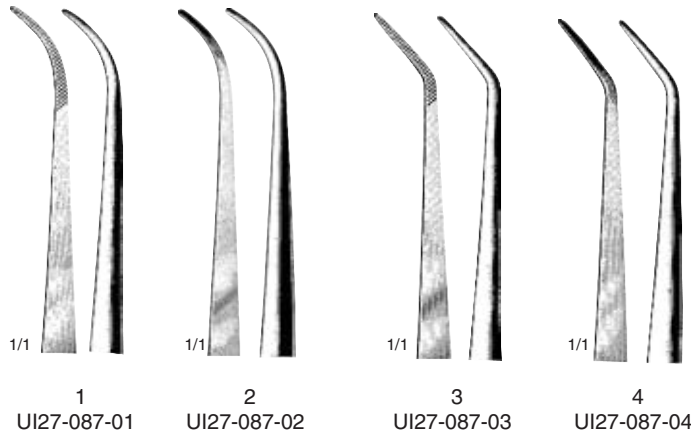

1/1

1

UI27-087-01

1/1

2

UI27-087-02

1/1

3

UI27-087-03

1/1

4

UI27-087-04

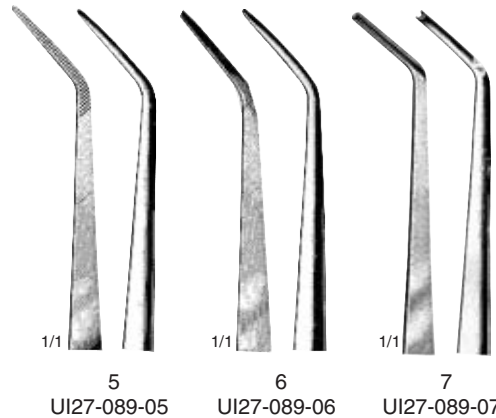

1/1

5

UI27-089-05

1/1

6

UI27-089-06

1/1

7

UI27-089-07

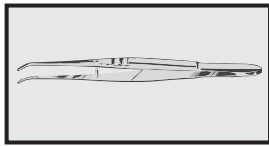

2/3

Flag
15 cm / 6"



1/1

1
UI27-091-01



1/1

2
UI27-091-02



1/1

3
UI27-091-03



1/1

4
UI27-091-04



1/1

5
UI27-091-05



1/1

6
UI27-091-06

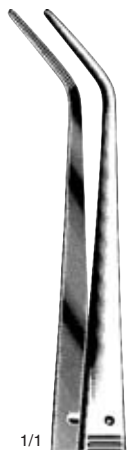

1/1

1
UI27-093-01



1/1

2
UI27-093-02



1/1

3
UI27-093-03



1/1

4
UI27-093-04



1/1

5
UI27-093-05



1/1

6
UI27-093-06



2/3

Meriam
15 cm / 6"

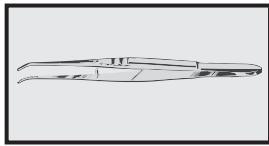

Landgraf
15 cm / 6"



1/1

1
UI27-095-01



1/1

2
UI27-095-02



1/1

3
UI27-095-03

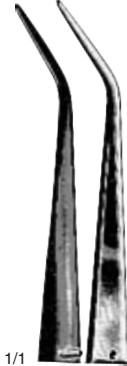

1/1

4
UI27-095-04



Perry
12.5 cm / 5"
UI27-097-12



1/1



Perry
12.5 cm / 5"
UI27-099-12

2/3



2/3

Zeibe
12.5 cm / 5"
UI27-101-12



1/2

Mod Martin
Suture & Membrane Forceps

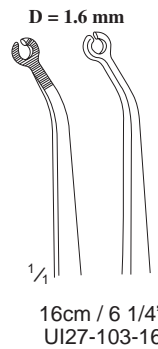

D = 1.6 mm

1/4

16cm / 6 1/4"
UI27-103-16

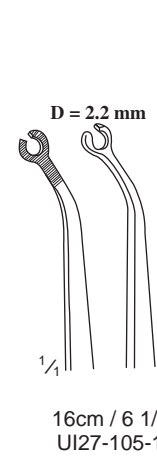

D = 2.2 mm

1/4

16cm / 6 1/4"
UI27-105-16



1/2

Mod Martin
Suture & Membrane Forceps

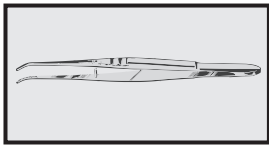

$\frac{2}{3}$
13.5cm/5¼"
UI27-109-01



$\frac{2}{3}$
13.5cm/5¼"
UI27-111-01



$\frac{2}{3}$
14cm/5½"
UI27-113-01



Brom-Allen
16.5 cm/6 ½"
UI27-115-16



$\frac{2}{3}$
Albrecht
16 cm/6 ¼"
UI27-117-16



$\frac{2}{3}$
Albrecht
16 cm/6 ¼"
UI27-119-16



$\frac{1}{1}$
Miller
15 cm / 6"
UI27-121-16
Practicing Paper
Forcep

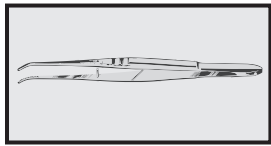

2/3
16cm/6 1/4"
UI27-123-16



2/3
16cm/6 1/4"
UI27-125-16



2/3
12.5cm/5"
UI27-127-12



2/3
13cm/4 3/4"
UI27-129-13



2/3
12cm/4 1/2"
UI27-131-12



2/3
11.5cm/4 1/2"
UI27-133-11



2/3
11.5cm/4 1/2"
UI27-135-16



1/2
17 cm / 6 3/4"
UI27-137-17



1/2
17 cm / 6 3/4"
UI27-139-17



1/2
12 cm / 4 3/4" UI27-141-12
14 cm / 5 1/2" UI27-141-14
16 cm / 6 1/4" UI27-141-16



1/2
13 cm / 5 1/2"
UI27-143-13

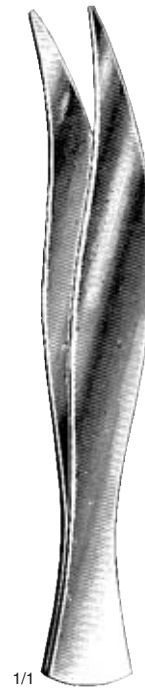

1/1
9 cm / 3 1/2"
UI27-145-09



1/1
9 cm / 3 1/2"
UI27-147-09

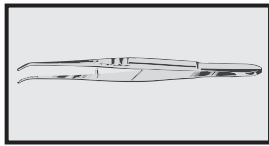

Adson

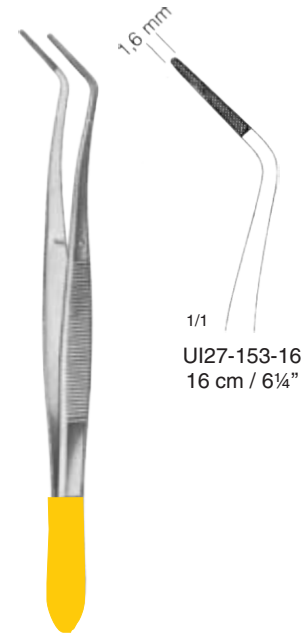
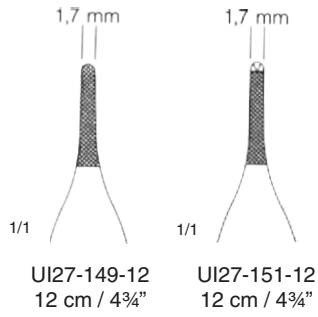

Meriam



Standard

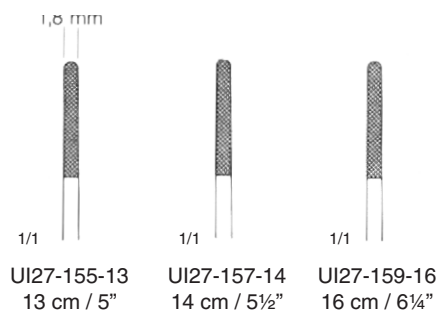

Cushing

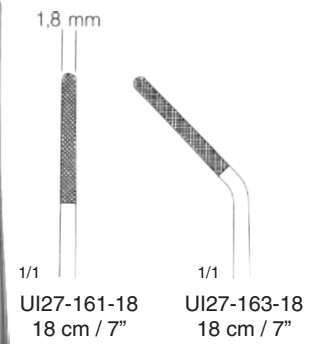

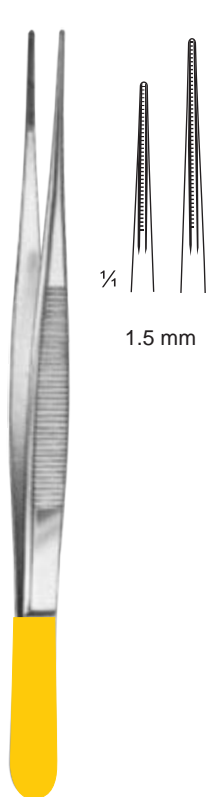
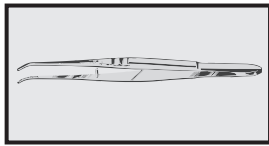

1/4
1.5 mm

DeBakey

UI27-165-16 = 16 cm/6 1/4"
UI27-165-20 = 20 cm/8"

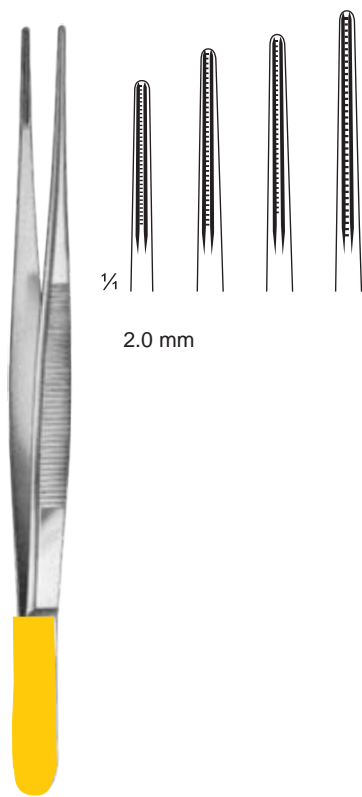

1/4
2.0 mm

UI27-167-16 = 16 cm/6 1/4"
UI27-167-20 = 20 cm/8"
UI27-167-24 = 24 cm/9 1/4"
UI27-167-30 = 30 cm/12"

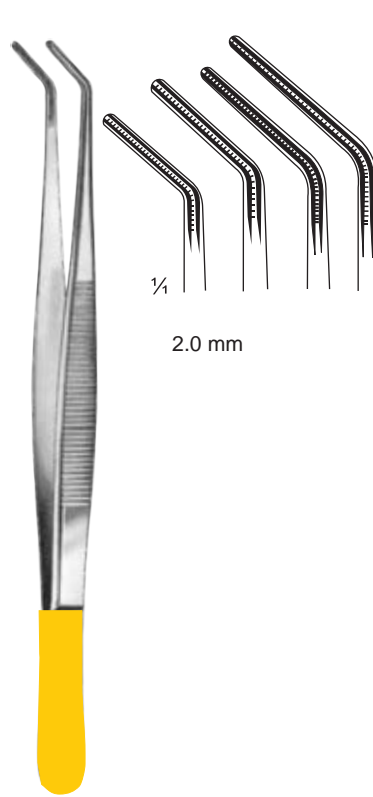

1/4
2.0 mm

UI27-169-16 = 16 cm/6 1/4"
UI27-169-20 = 20 cm/8"
UI27-169-24 = 24 cm/9 1/4"
UI27-169-30 = 30 cm/12"

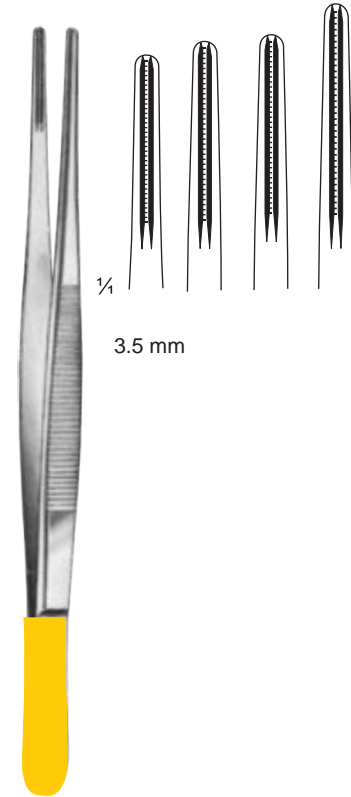

1/4
3.5 mm

De Bakey

UI27-171-16 = 16 cm/6 1/4"
UI27-171-20 = 20 cm/8"
UI27-171-24 = 24 cm/9 1/4"
UI27-171-30 = 30 cm/12"

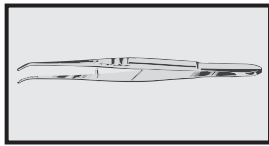

15cm / 6"
UI27-173-30
(Crane-Kaplan)
Goldman-fox

15cm / 6"
UI27-175-30
(Crane-Kaplan)
Goldman-fox

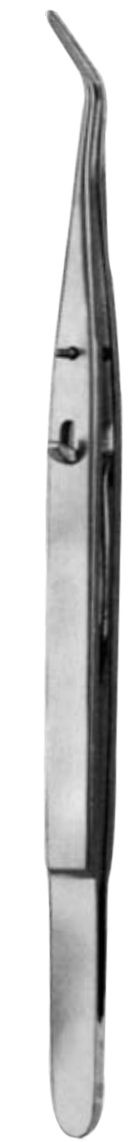

16cm / 6½"
UI27-177-30
Fig-18L
Locking



15cm / 6"
UI27-179-30
Fig-1
Self Locking



15cm / 6"
UI27-181-30
Fig-2
Self Locking

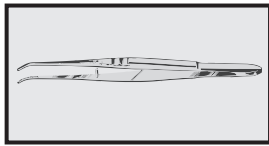

14 cm/5 1/2"
UI27-193-30
self-retaining,
round ends



14 cm/5 1/2"
UI27-195-30
self retaining,
flat ends



	cm	inches	
UI27-197-30	12	4 3/4	UI27-199 -12
UI27-197-14	14	5 1/2	UI27-199-14
UI27-197-16	16	6 1/4	UI27-199-16



13 cm/5 1/8"
UI27-201-13



13 cm/5 1/8"
UI27-203-13
UI27-205-00

UI27-205-00
pair



16 cm/6 1/4"
UI27-207-19
UI27-209-00



16 cm/6 1/4"
UI27-211-16
UI27-213-00

UI27-213-00
pair



16 cm/6 1/4"
UI27-215-16 - UI27-221-02



UI27-215-16



UI27-217-16

Spare tips, in pairs

UI27-219-02

UI27-221-02

insulated handle



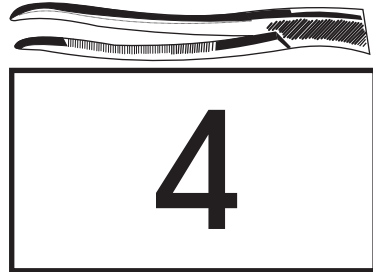

HEMOSTATIC FORCEPS

 URIYA Instruments®



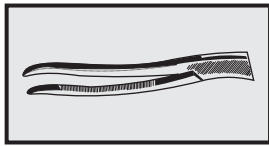

		Pean	
		Straight	Curved
cm	in	UI28-001-13	UI28-003-13
13	5	UI28-001-14	UI28-003-14
14	5½	UI28-001-16	UI28-003-16
16	6¼		

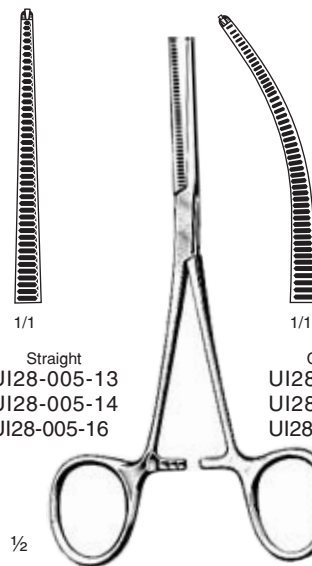

		Kocher	
		Straight	Curved
cm	in	UI28-005-13	UI28-007-13
13	5	UI28-005-14	UI28-007-14
14	5½	UI28-005-16	UI28-007-16
16	6¼		

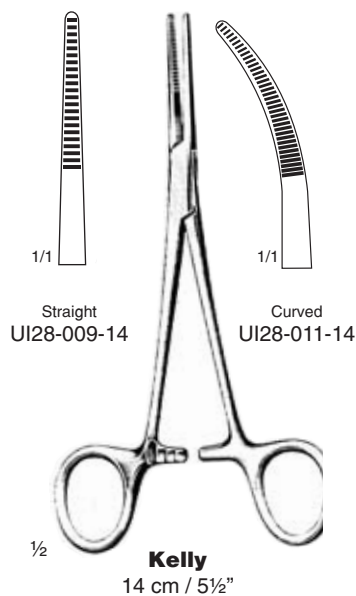

		Straight	Curved
		UI28-009-14	UI28-011-14
Kelly			
14 cm / 5½"			

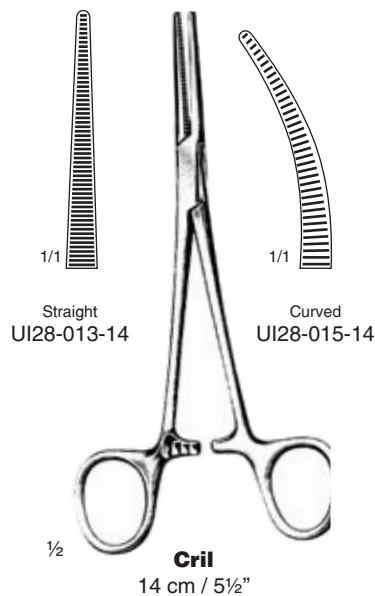

		Straight	Curved
		UI28-013-14	UI28-015-14
Cril			
14 cm / 5½"			

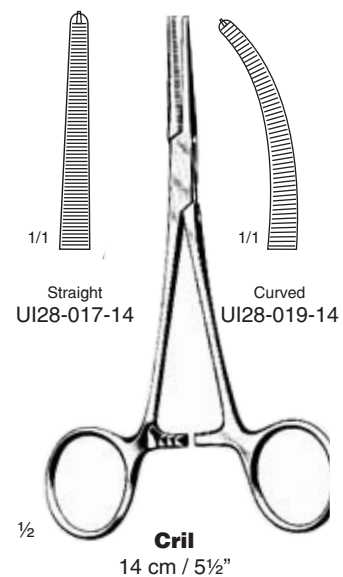

		Straight	Curved
		UI28-017-14	UI28-019-14
Cril			
14 cm / 5½"			

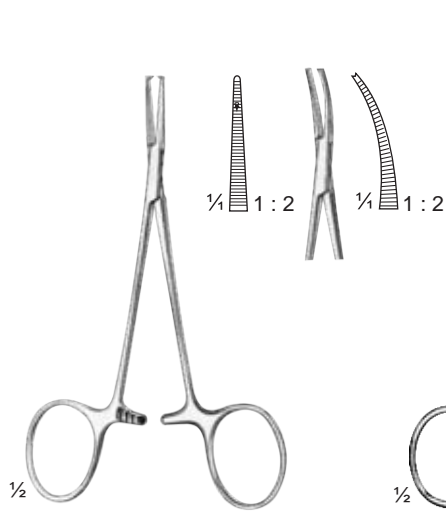
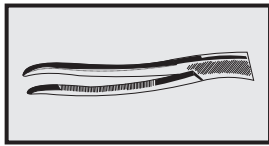

Halstead-Mosquito (Micro)

cm	in	Straight	Curved
12.5	5	UI28-021-12	UI28-023-12



Halstead-Mosquito

cm	in	Straight	Curved
13	5	UI28-025-13	UI28-027-18
18	7	UI28-025-13	UI28-027-18

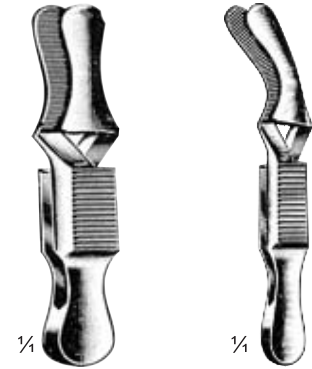

Dieffenbach
3.5 cm / 1½"
UI28-029-03
5 cm / 2"
UI28-029-05

Dieffenbach
3.5 cm / 1½"
UI28-031-04
5 cm / 2"
UI28-031-05

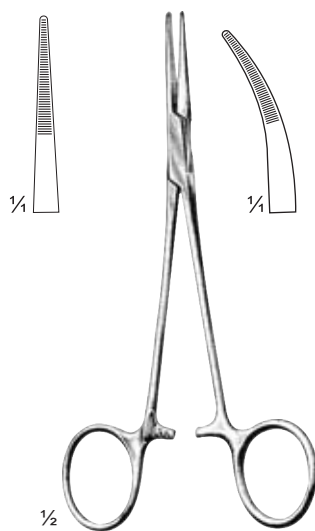

Providence-Hospital

cm	in	Straight	Curved
14	5 ½	UI28-033-14	UI28-035-14

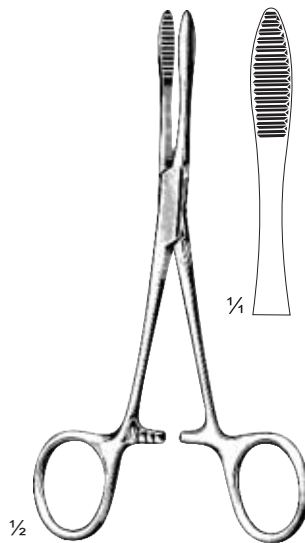

Pean

cm	in	Straight	Curved
14	5 ½	UI28-037-14	
16	6 ¼	UI28-037-16	

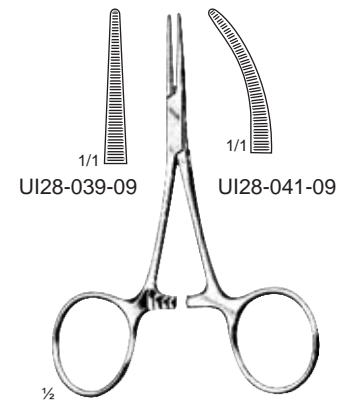

Hartmann
10 cm / 4"

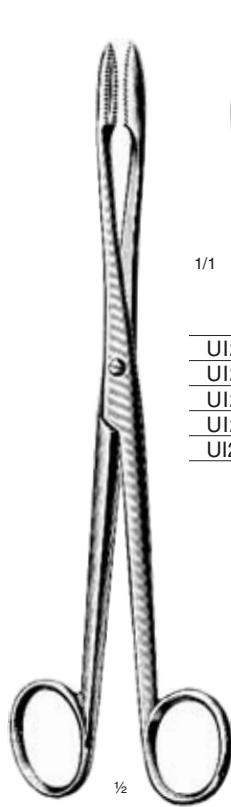
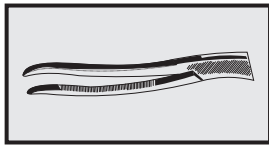

Gross-Maier

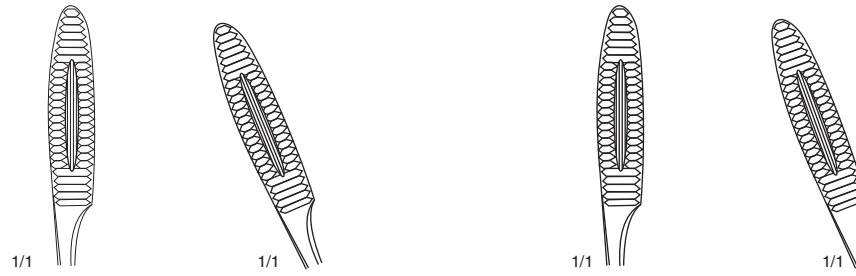

		cm	in		
UI28-043-14	UI28-045-14	14.5	5 1/2	UI28-047-14	UI28-049-14
UI28-043-16	UI28-045-16	16	6 1/4	UI28-047-16	UI28-049-16
UI28-043-18	UI28-045-18	18	7	UI28-047-18	UI28-049-18
UI28-043-20	UI28-045-20	20	8	UI28-047-20	UI28-049-20
UI28-043-25	UI28-045-25	25	10	UI28-047-25	UI28-049-25

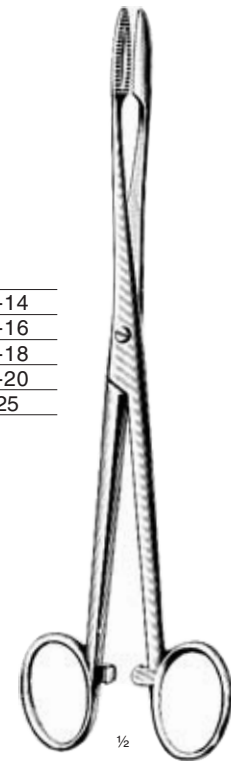

Gross-Maier

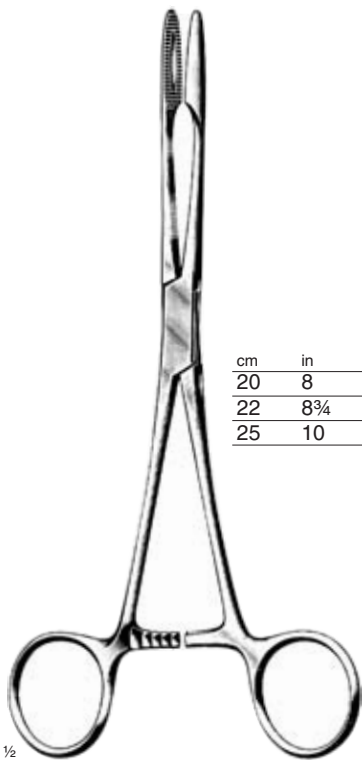

Gross-Maier

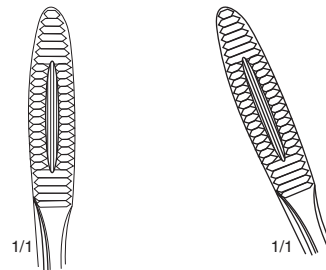

cm	in		
20	8	UI28-051-20	UI28-053-20
22	8 3/4	UI28-051-22	UI28-053-22
25	10	UI28-051-25	UI28-053-25



Backhaus

cm	in	
8	3 1/4	UI28-055-08
11	4 1/2	UI28-055-11
13	5	UI28-055-13
15	6	UI28-055-15



SchZBdel
9 cm / 3 1/2"
UI28-057-09



Jones
5 cm / 2"
UI28-059-05
9 cm / 3 1/2"
UI28-059-09

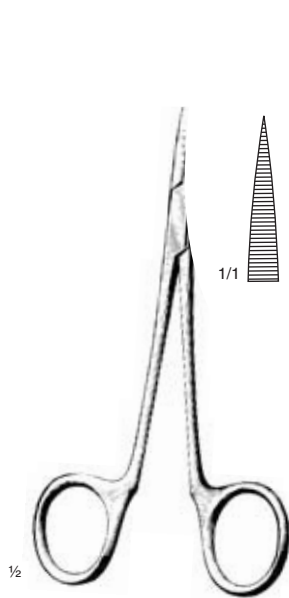
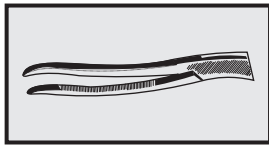

Physician
13 cm / 5"
UI28-061-13



Allis
15 cm / 6"

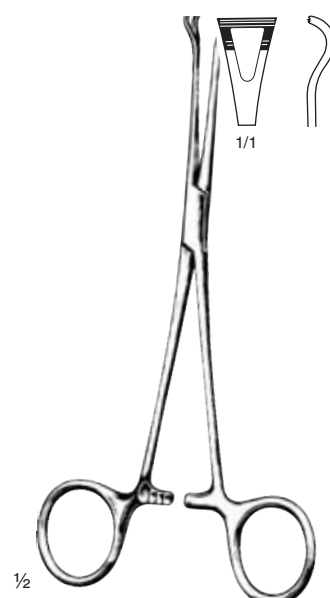

Babcock
16 cm / 6¼"
UI28-067-16



Allis-Baby
14.5 cm / 5¾"
UI28-069-14



Cheatele
27 cm / 10½"
UI28-071-27

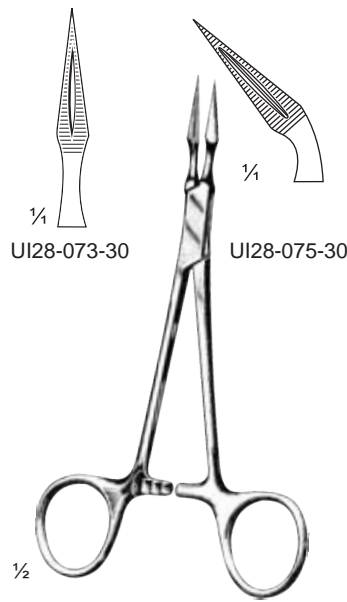

Stieglitz
13,5 cm / 5 ½"



Peet
11,5 cm / 4 ½"
UI28-077-30

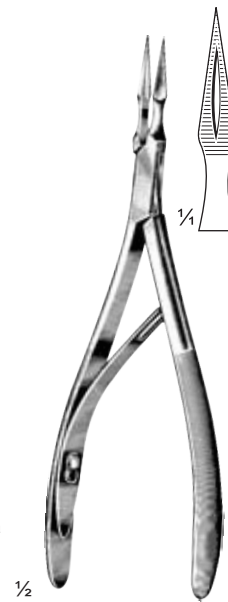

Ralk
15 cm / 6"
UI28-079-30



Ralk
15 cm / 6"
UI28-081-30

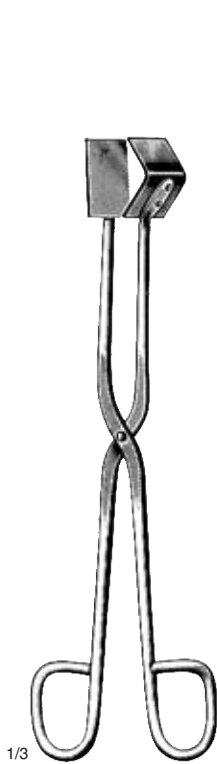
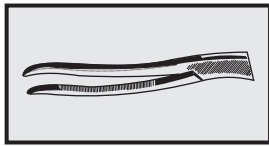

1/3

24 cm / 9½"
UI28-083-24

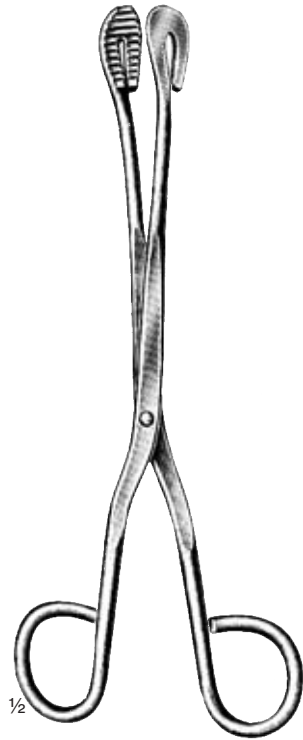

1/2

Universal
20 cm / 8" UI28-085-20
28 cm / 11" UI28-085-28

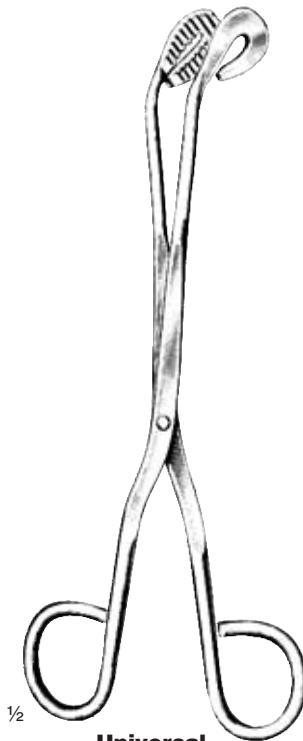

1/2

Universal
20 cm / 8" UI28-087-20
28 cm / 11" UI28-087-28



1/6

58 cm / 22¾"
UI28-089-58



1/6

Sauerbruch
55 cm / 21½"
UI28-091-55



1/3

22 cm / 8" UI28-093-22
32 cm / 12½" UI28-093-32
50 cm / 20" UI28-093-50



1/3

22 cm / 8" UI28-095-22
25 cm / 10" UI28-095-25
32 cm / 12½" UI28-095-32
50 cm / 20" UI28-095-50

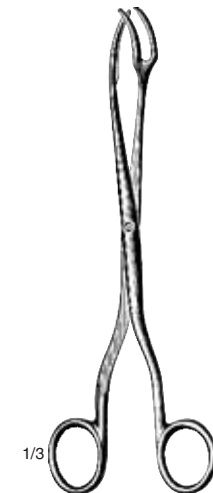

1/3

20 cm / 8" UI28-097-20
30 cm / 12" UI28-097-30

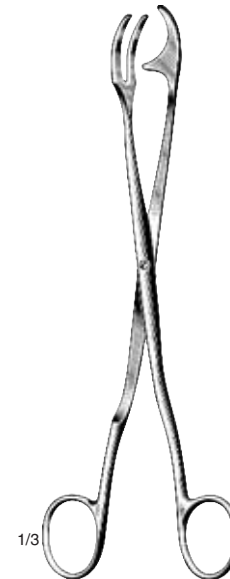

1/3

Rogge
23 cm / 9"
UI28-099-23



1/3

24.5 cm / 9¾"
UI28-101-24



5

ROOT ELEVATORS

 URIYA Instruments®

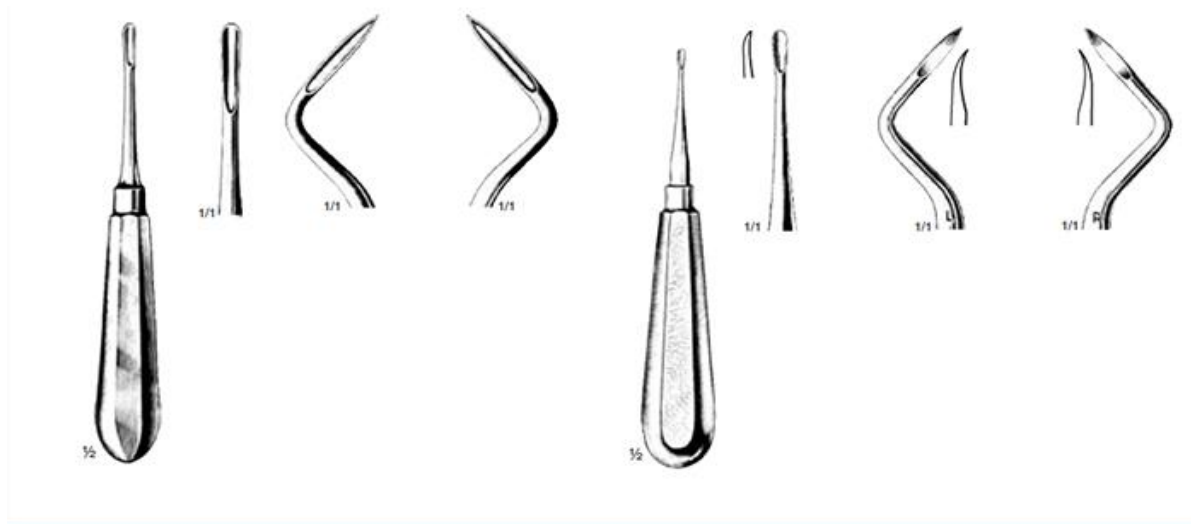

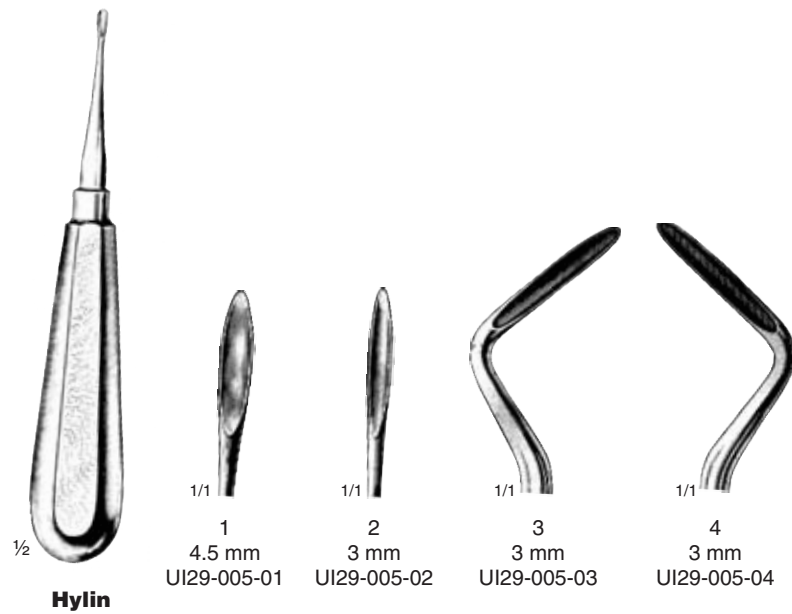
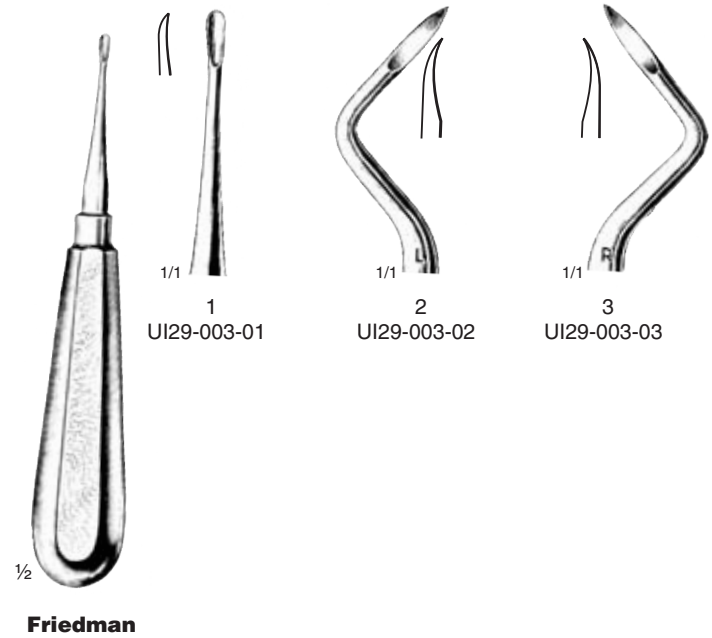
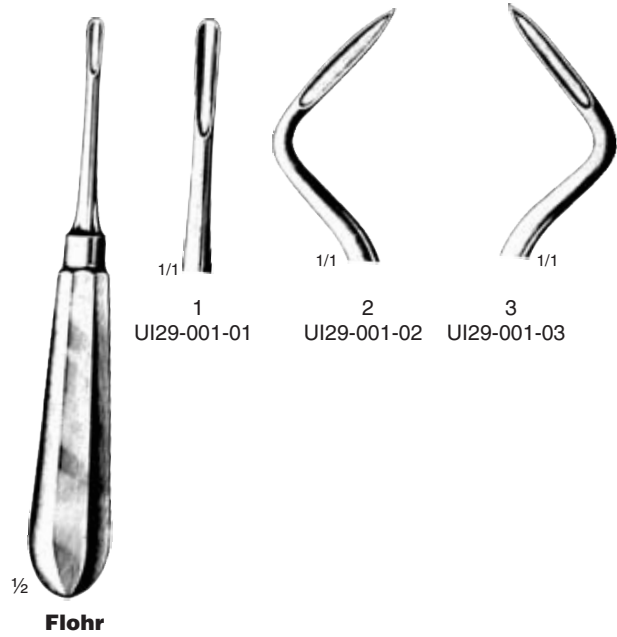
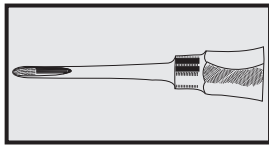

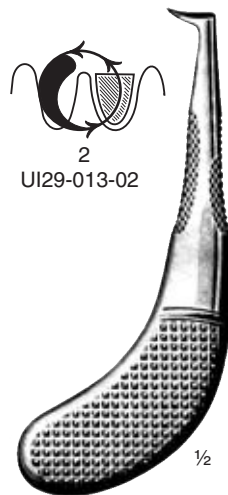
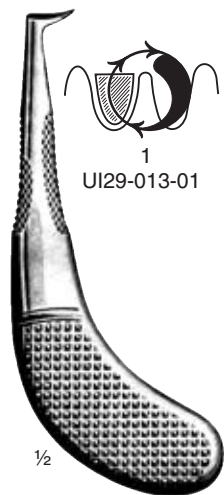
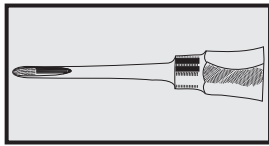

Krallenheber
UI29-013-00

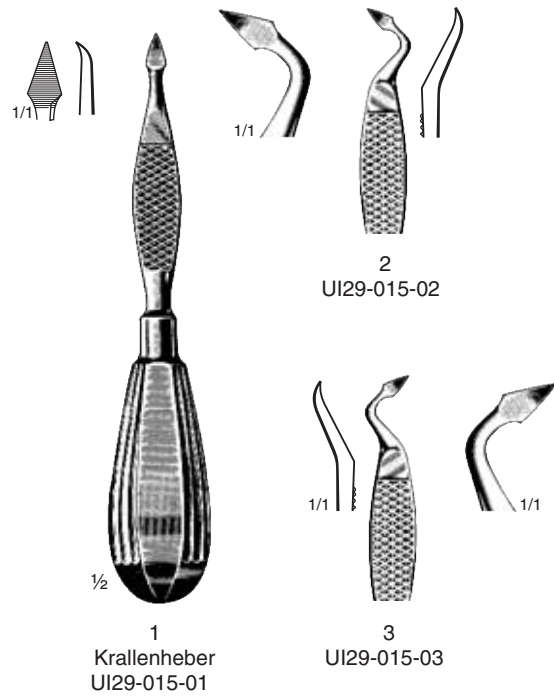

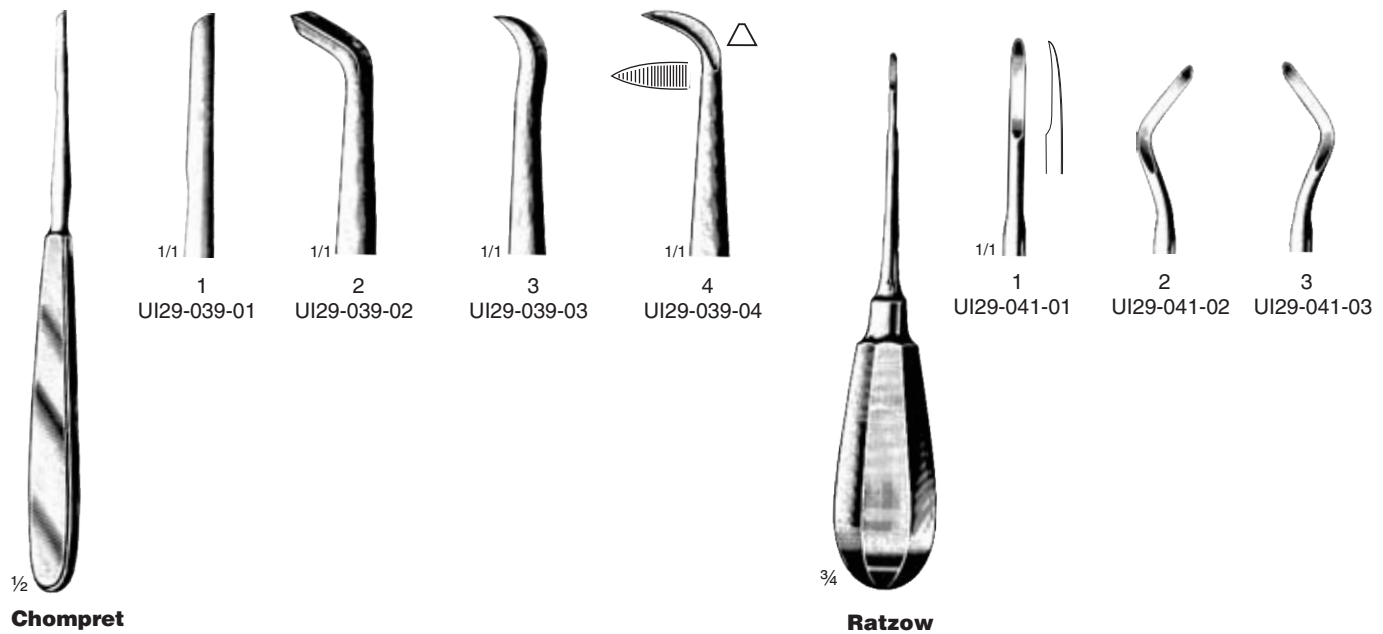
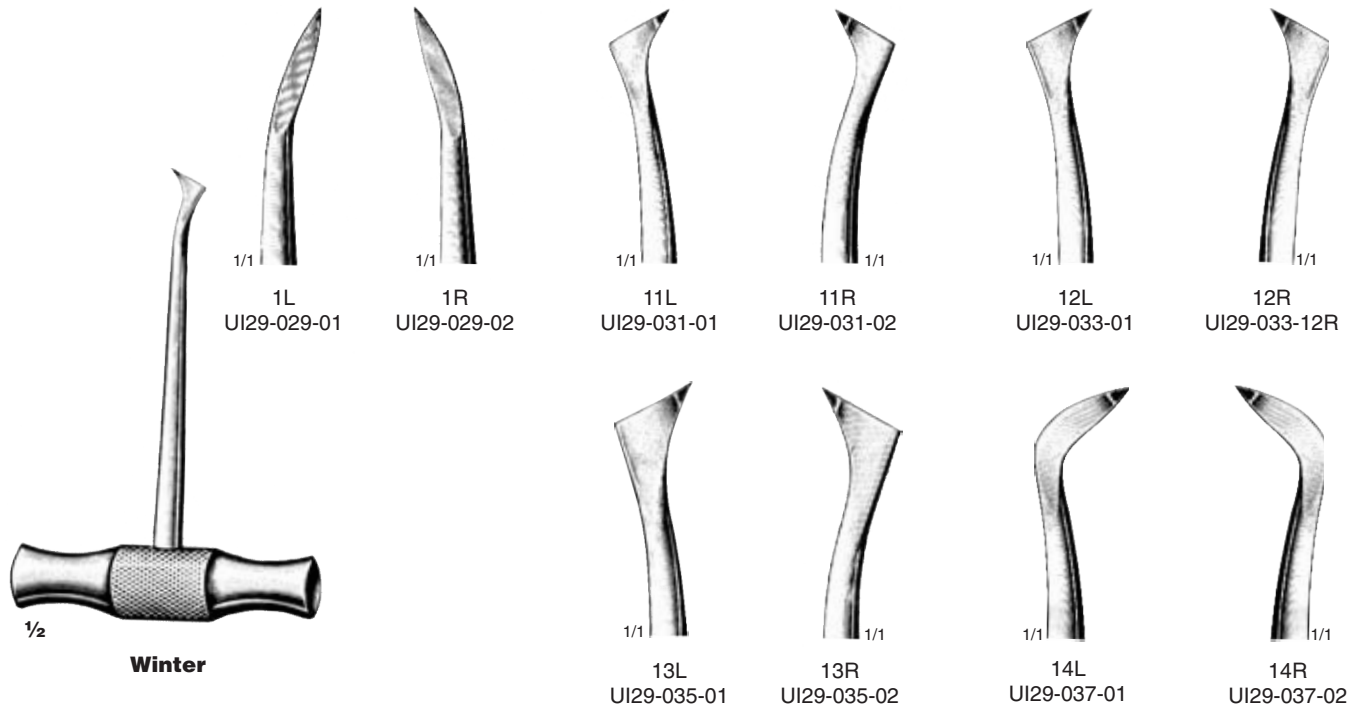
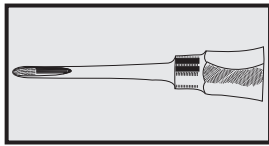

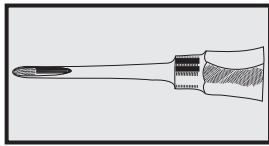

Heidebrink

1/2

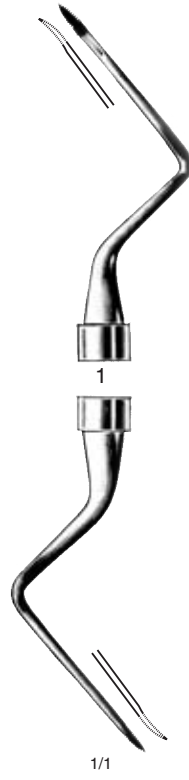

Heidebrink
UI29-043-01

1/1

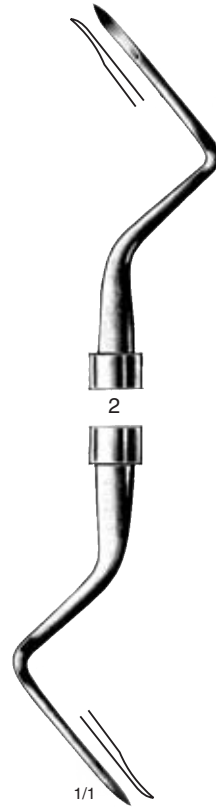

Heidebrink
UI29-045-02

1/1

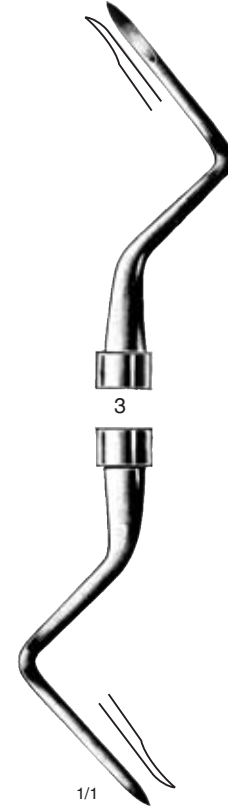

Heidebrink
UI29-047-03

1/1



Heidebrink
UI29-049-00

1/2



Heidebrink
UI29-049-01
UI29-051-01

1/1

1



Heidebrink
UI29-049-02
UI29-051-02

1/1

2



Heidebrink
UI29-049-03
UI29-051-03

1/1

3



Heidebrink
UI29-051-00

1/2

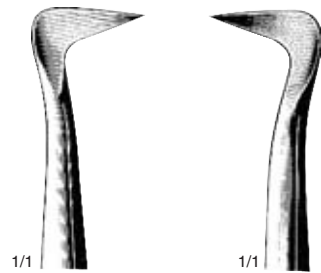
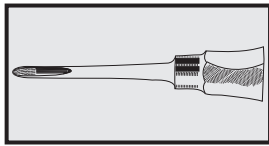

1/1
**1L
Seldin**
UI29-053-01



1/1
**1R
Seldin**
UI29-053-02



1/1
**2
Seldin**
UI29-055-02



1/1
**3
Seldin**
UI29-055-03

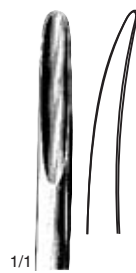
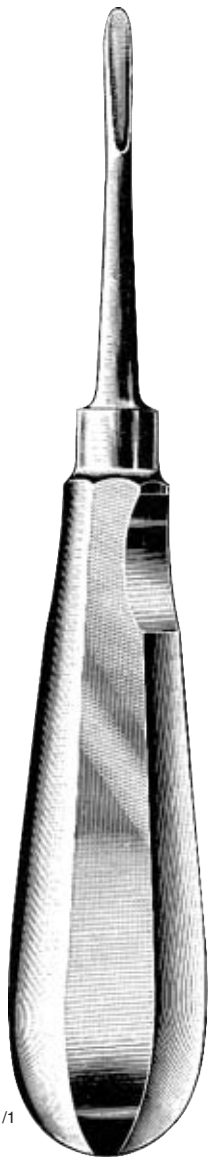

1/1
**3A
Cryer**
UI29-057-31



1/1
**4L
Seldin**
UI29-059-04



1/1
**4R
Seldin**
UI29-059-05



1/1
**6
Crane Pick**
UI29-061-06



1/1
**8
Miller**
UI29-063-08



1/1
**9
Miller**
UI29-063-09



1/1
**10
Miller**
UI29-065-10



1/1
**11
Miller**
UI29-065-11



1/1
**12
Cryer**
UI29-067-12

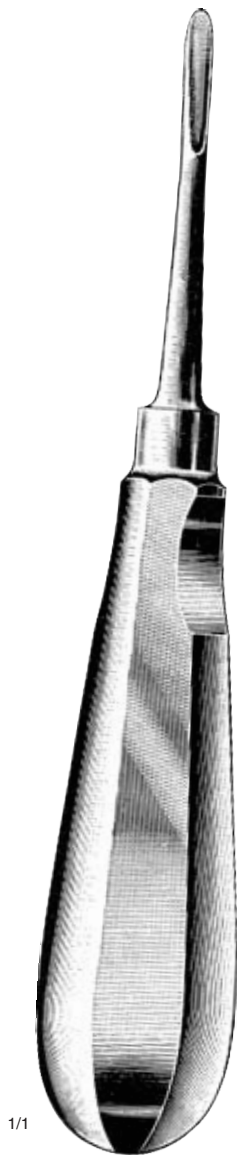
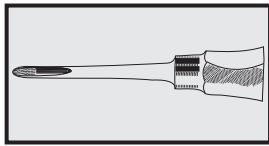

1/1
27
Cryer
UI29-069-27



1/1
28
Cryer
UI29-071-28



1/1
34
Seldin
UI29-073-34



1/1
34S
Seldin
UI29-075-34

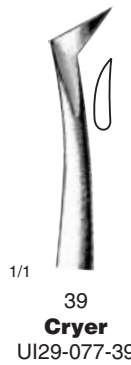

1/1
39
Cryer
UI29-077-39

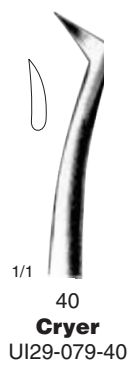

1/1
40
Cryer
UI29-079-40



1/1
46
UI29-081-46

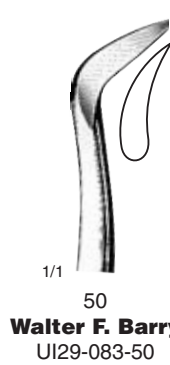

1/1
50
Walter F. Barry
UI29-083-50

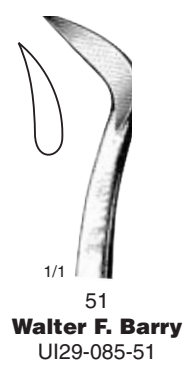

1/1
51
Walter F. Barry
UI29-085-51



1/1
301
Apical
UI29-087-01

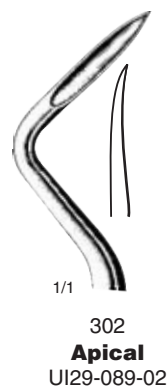

1/1
302
Apical
UI29-089-02

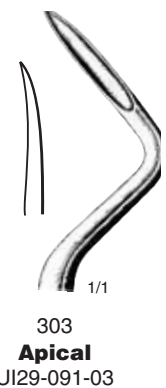

1/1
303
Apical
UI29-091-03

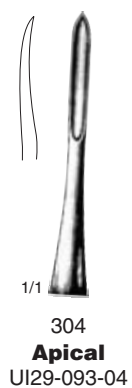

1/1
304
Apical
UI29-093-04

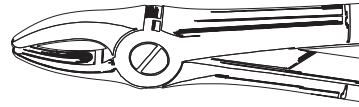

EXTRACTING FORCEPS

 URIYA Instruments®

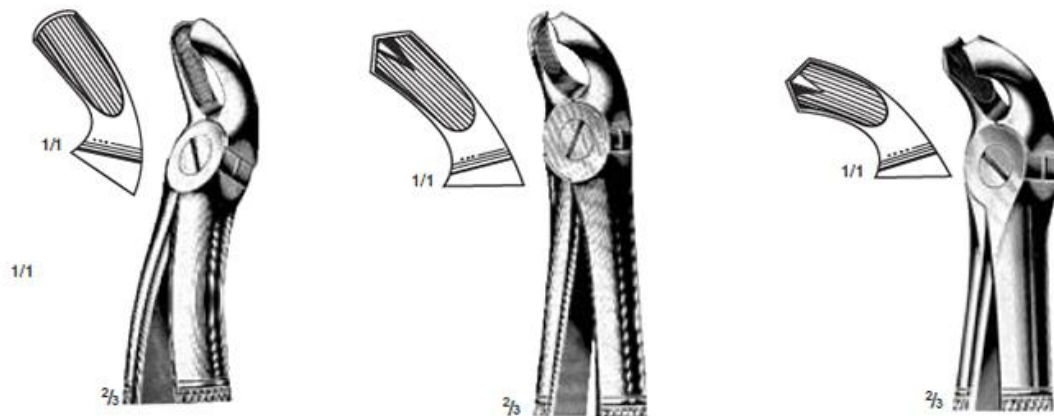

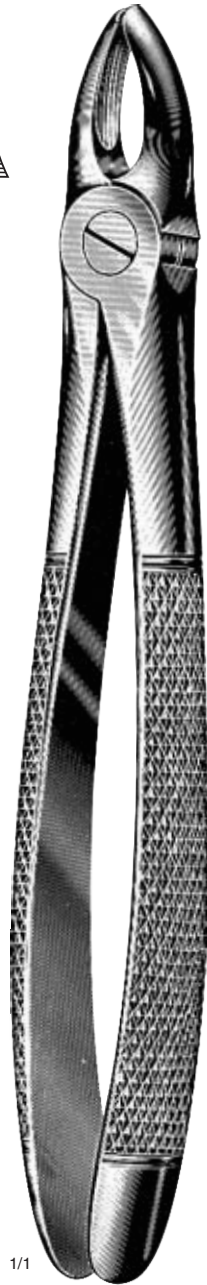
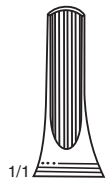
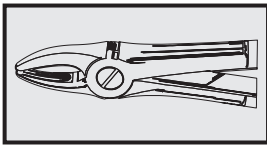

1
UI30-001-01
For Upper Centrals and Canines

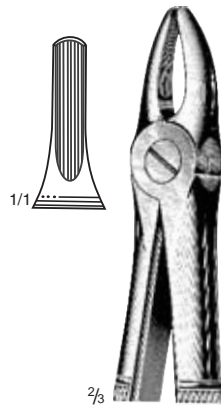

2
UI30-003-02
For Upper Laterals and Bicuspids

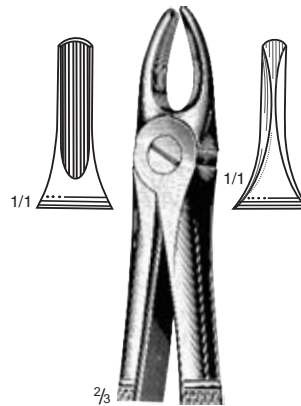

3
UI30-005-03
For Upper Incisors and Canines
Crowned Internally & Externally

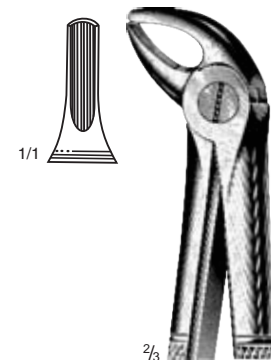

4
UI30-007-04
For Lower Incisors and Canines

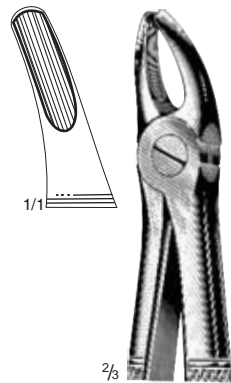

7
UI30-009-07
For Upper Bicuspids, either side

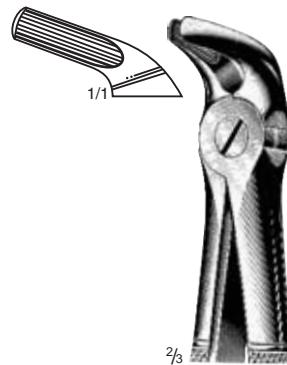

8
UI30-011-08
For Lower Bicuspids, either side

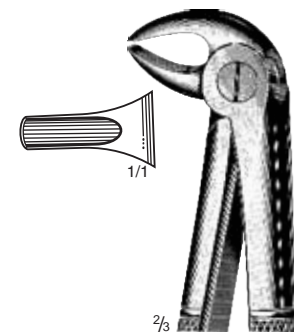

13
UI30-013-13
For Lower Bicuspids, either side

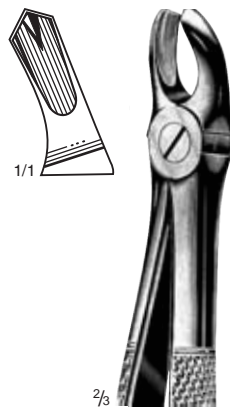

17
UI30-015-17
For Right Upper Molars

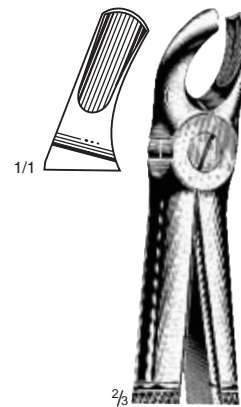

18
UI30-017-18
For Left Upper Molars

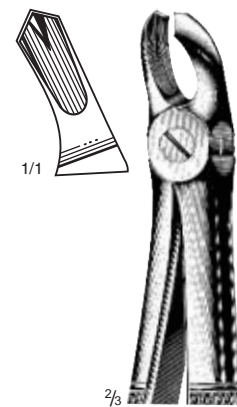

18A
UI30-019-18
For Upper Molars-either side

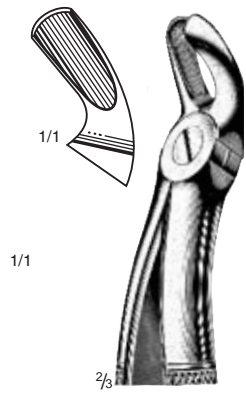
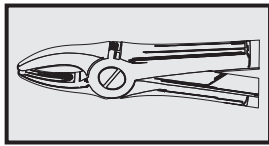

19
UI30-021-19
For Upper Wisdoms-either side

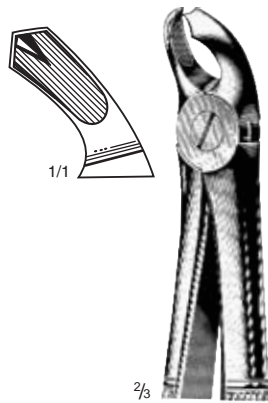

20
UI30-023-20
For Lower Wisdoms-either side

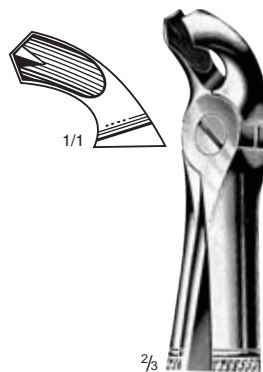

21
UI30-025-21
For Lower Molars-either side

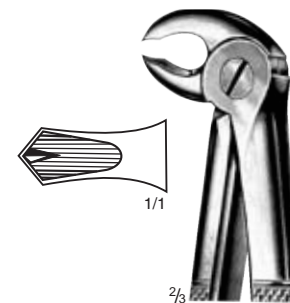

22
UI30-027-22
For Lower Molars-either side

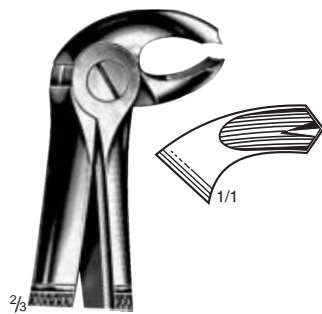

23
UI30-029-23
For Right Lower Molars

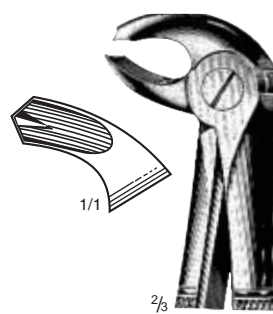

24
UI30-031-24
For Left Lower Molars

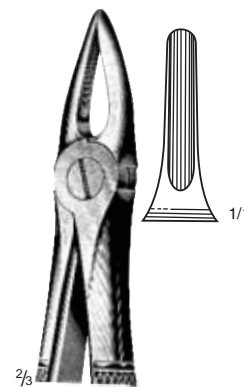

29
UI30-033-29
For Upper Roots and Incisors-either side

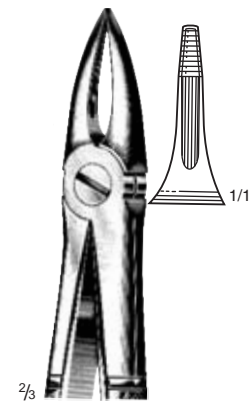

29N
UI30-035-29
For Roots of Upper Incisors

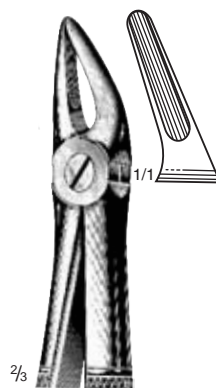

30
UI30-037-30
For Upper Roots and Incisors-either side

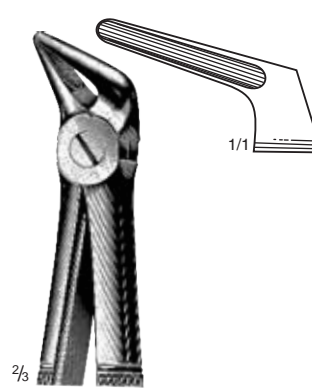

31
UI30-039-31
For Lower Roots-either side

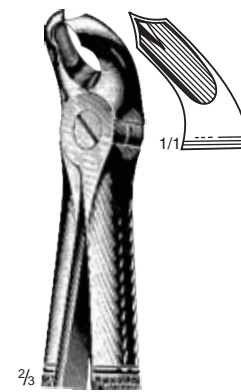

32
UI30-041-32

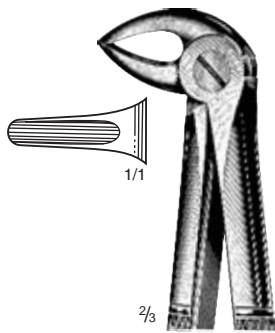
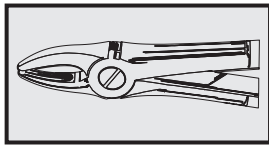

33
UI30-043-33

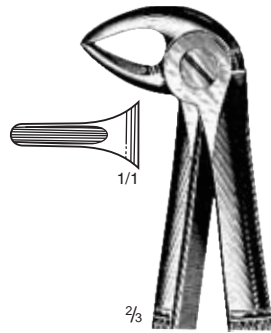

33A
UI30-045-33

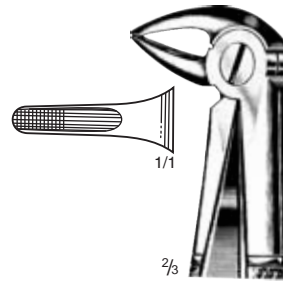

33C
UI30-047-33

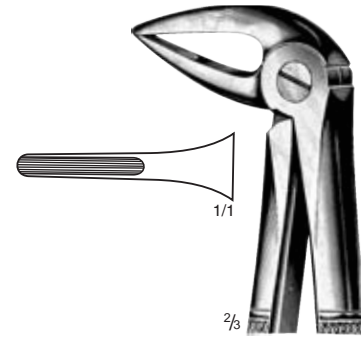

33M
UI30-049-33

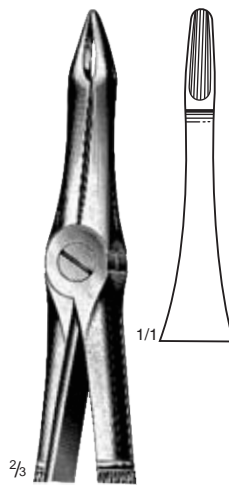

41
UI30-051-41

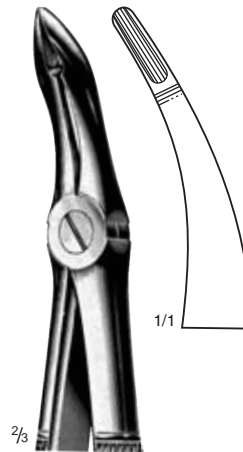

44
UI30-053-44

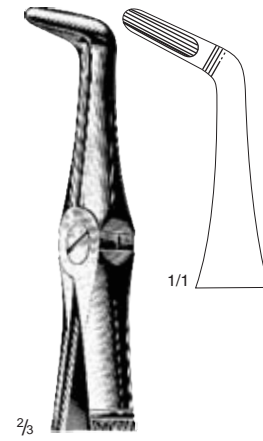

45
UI30-059-45

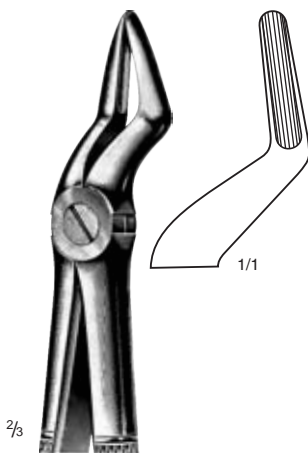

51
UI30-055-51

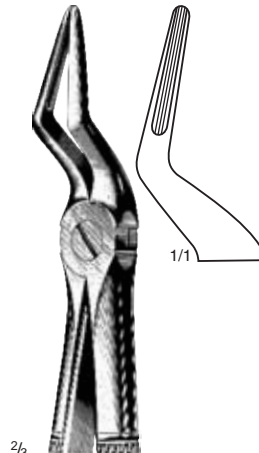

51A
UI30-061-51

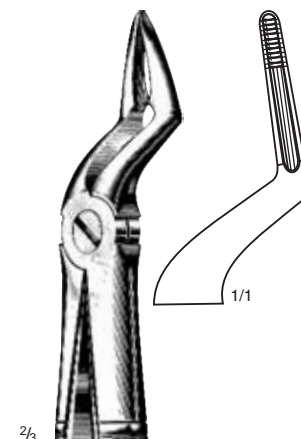

51C
UI30-057-51

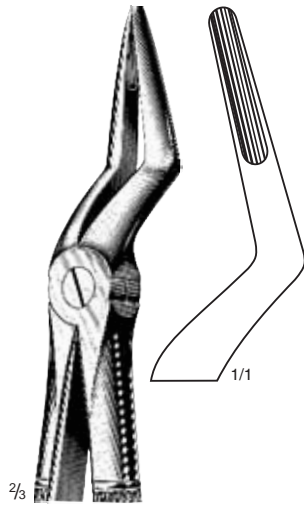
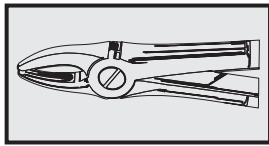

51M
UI30-063-51
For Deep Upper Roots

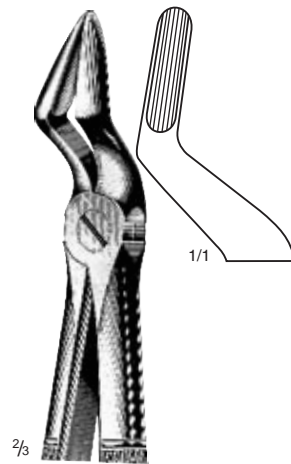

52
UI30-069-52
For Upper Roots and Canines

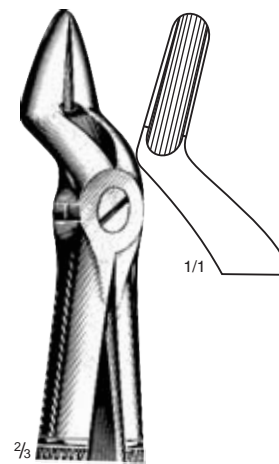

52A
UI30-065-52
For Upper Teeth and Resection-either side

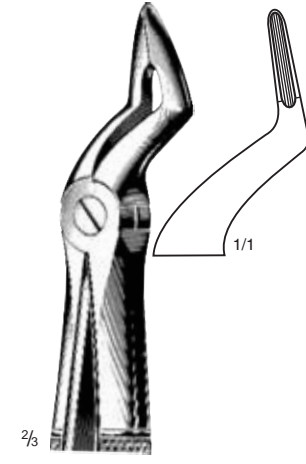

53 Witzel
UI30-071-53
For Upper Roots

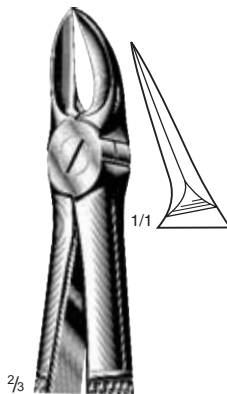

55
UI30-067-55
For Separating Upper Molar Roots

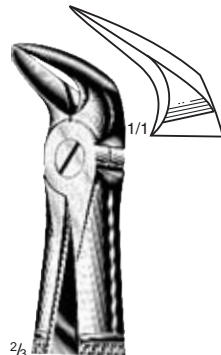

56
UI30-073-56
For Separating Lower Molar Roots

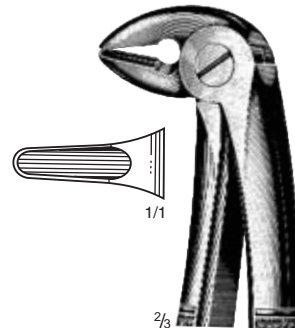

59
Busch
UI30-075-59
Resection Forceps for Lower Roots

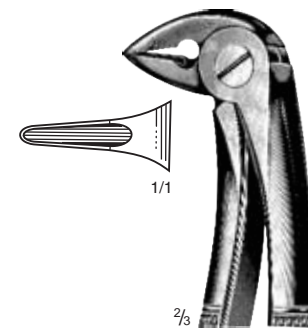

60
Busch
UI30-077-60
Resection Forceps for Lower Roots

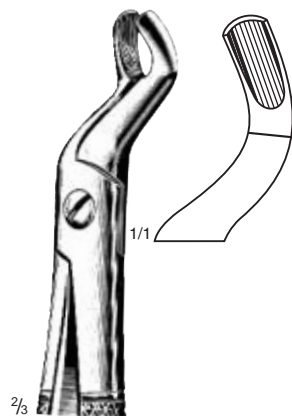

67
UI30-079-67
For Upper Wisdoms, either side

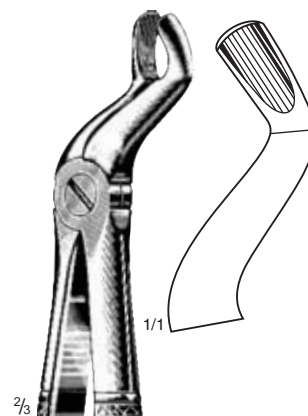

67A
UI30-081-67
For Upper Wisdoms, either side

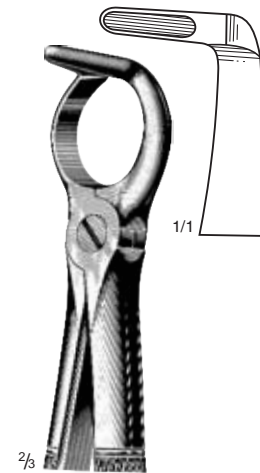

68
UI30-083-68
For Lower Roots, either side

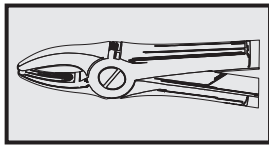

73
UI30-085-73

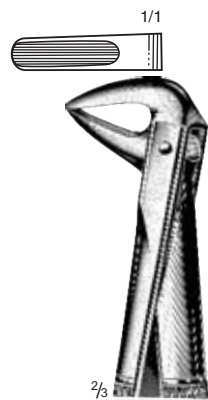

74
UI30-087-74



74M
UI30-089-74

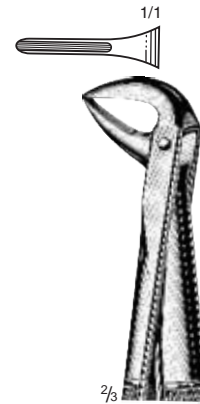

74N
UI30-091-74

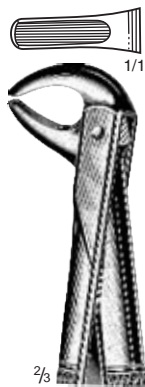

75
UI30-093-75

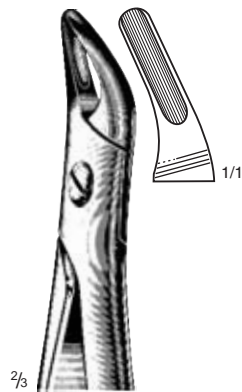

76
Lawrence read
UI30-095-76

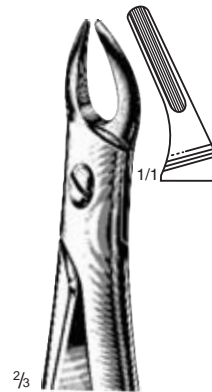

76N
Lawrence read
UI30-097-76

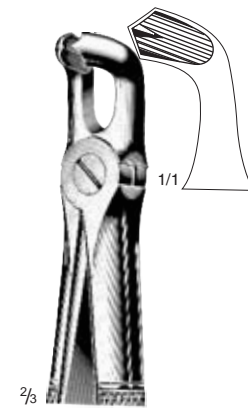

79
UI30-099-79

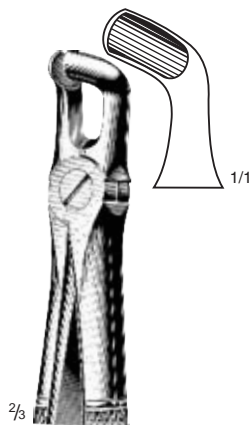

79A
UI30-103-79
For Lower Wisdoms
either side



86A
UI30-105-86
For Lower Molar with decayed or
broken-down crown, either side



86B
UI30-107-86
For Lower Molar with decayed or
broken-down crown, either side



86C
UI30-109-86
For Lower Molar with decayed or
broken-down crown, either side

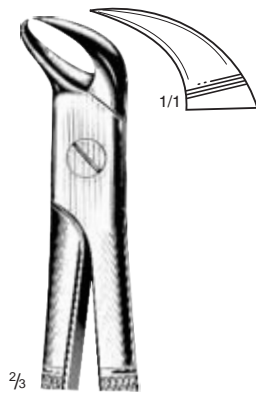
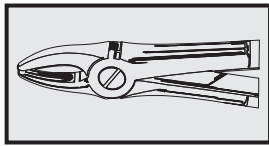

87
UI30-111-87
For Lower Molar with decayed or broken-down crown, either side

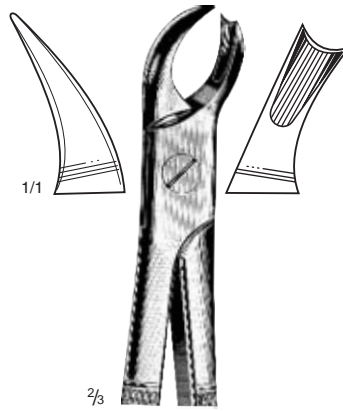

89
UI30-113-89
For Right Upper Molar

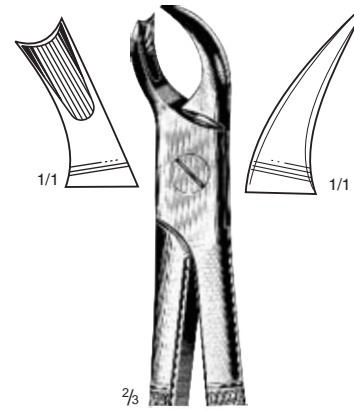

90
UI30-115-90
For Left Upper Molar

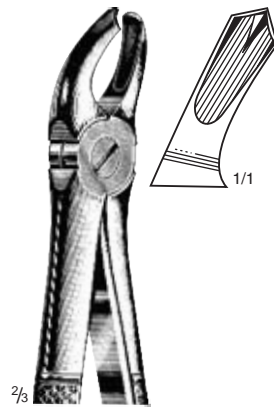

94
UI30-117-94
For Right Upper Molar

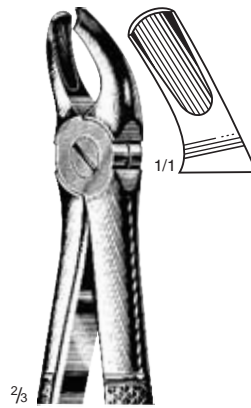

95
UI30-119-95
For Left Upper Molar



99
Wood
UI30-121-99
For Broken-Down Lower Molar either side



99 1/4
Passow
UI30-123-99
For Broken-Down Lower Molar either side

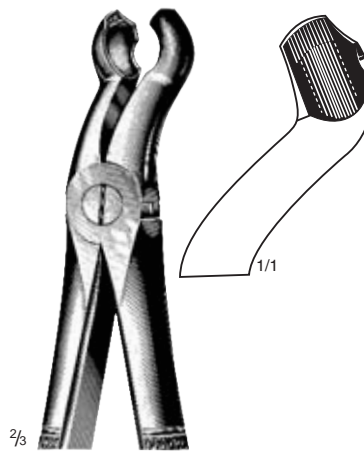

121
Ogden-Felsch
UI30-125-21
For Upper Wisdoms

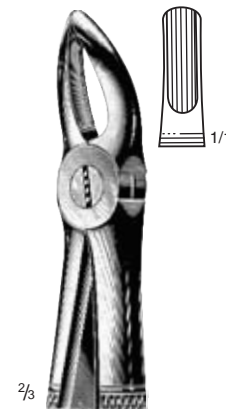

136
Guy
UI30-127-36
For Upper Centrals and Roots

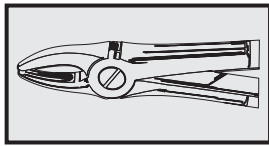

137
Guy
UI30-129-37
For Lower Centrals and Roots

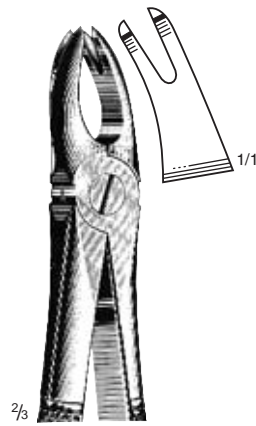

166
Trotter
UI30-131-66
For Upper Teeth, Bicuspids



167
Trotter
UI30-133-67
For Lower Teeth, Bicuspids

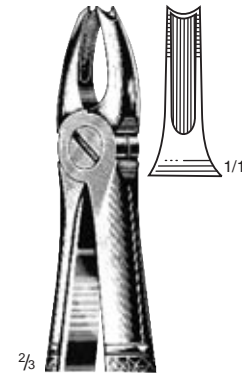

168
Trotter
UI30-135-68
For Upper Canines

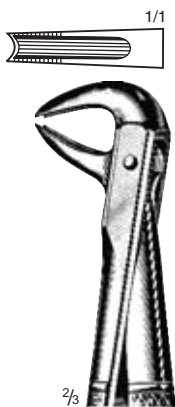

169
Trotter
UI30-137-69
For Lower Canines and, Bicuspids

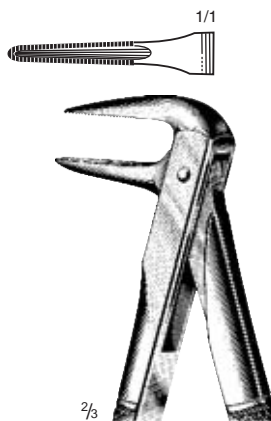

233
Trotter
UI30-139-33
For Lower Roots

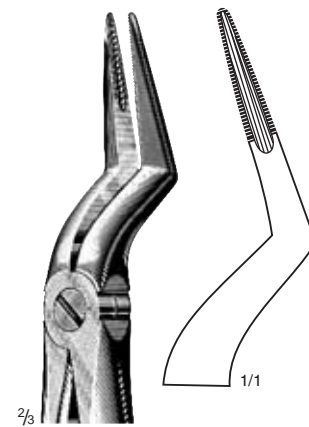

235
Trotter
UI30-141-35
For Upper Roots

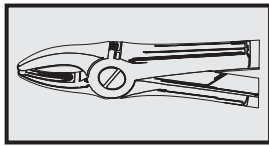

1
UI30-149-01
For Upper Central and Canines

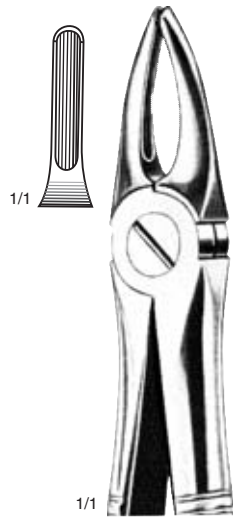

2
UI30-143-02
For Upper Laterals
and Bicuspids

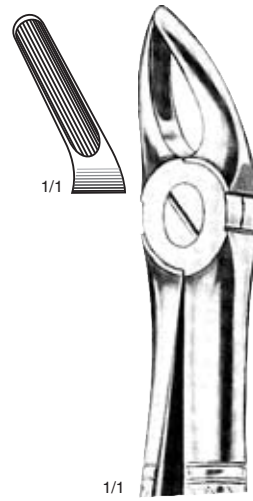

7
UI30-145-07
For Upper Bicuspid
either side

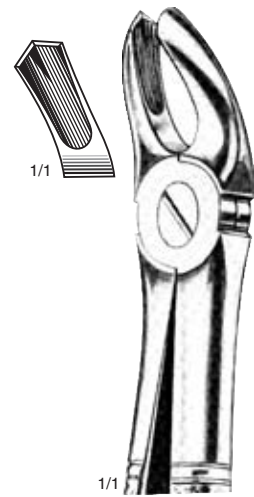

17
UI30-147-17
For Right Upper Molars

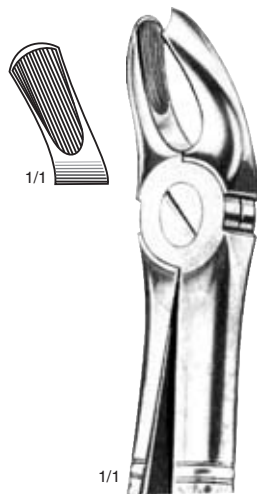

18
UI30-151-18
For Left Upper Molars

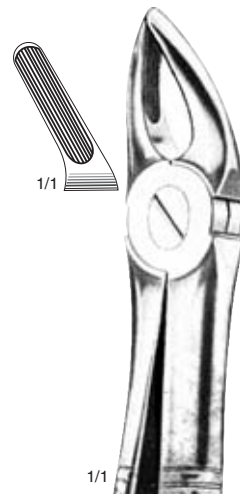

30
UI30-153-30
For Upper Incisors and Roots
either side

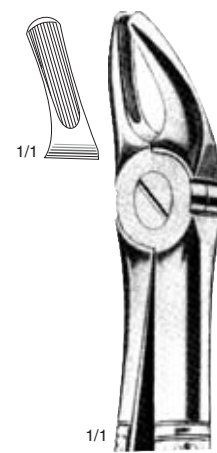

39
UI30-155-39
For Upper Molars
either side

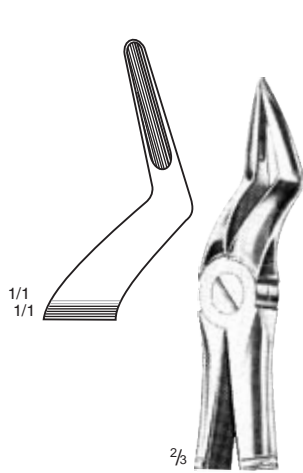
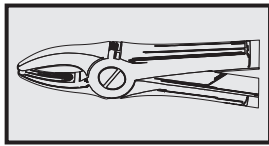

51
UI30-157-51
For Upper Roots

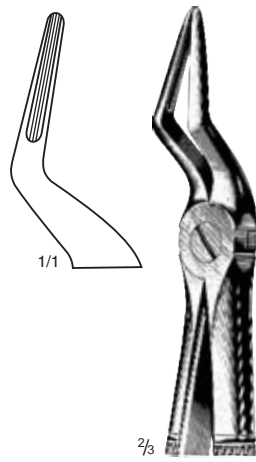

51A
UI30-159-51
For Upper Roots

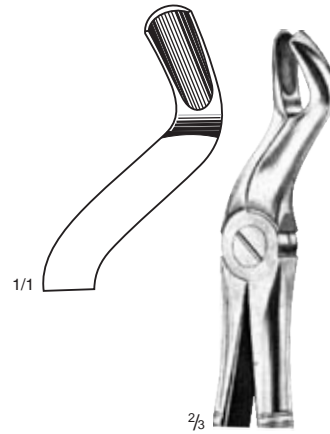

67A
UI30-161-67
For Upper Wisdoms, either side

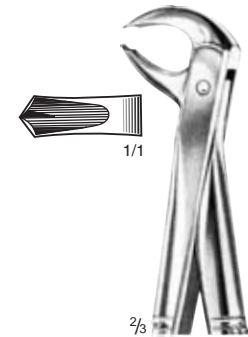

73
UI30-163-73
For Lower Molars-either side

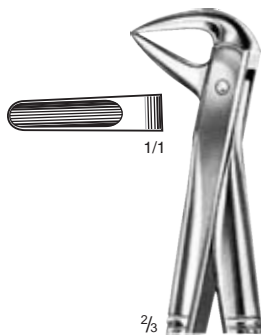

74
UI30-165-74
For Lower Incisors and Roots-either side

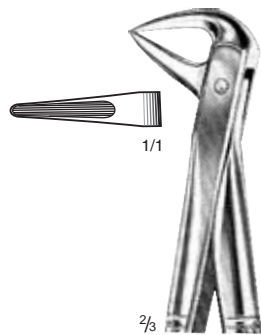

74N
UI30-167-74
For Lower Incisors and Roots

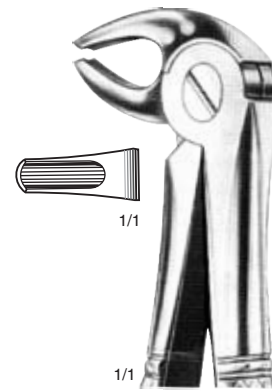

13
UI30-169-13
For Lower Bicuspid-either side

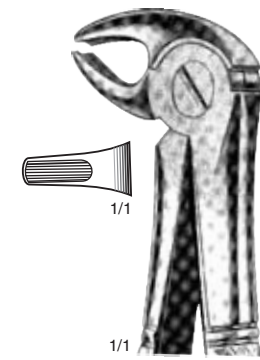

13S
UI30-171-13
For Lower Bicuspid-either side

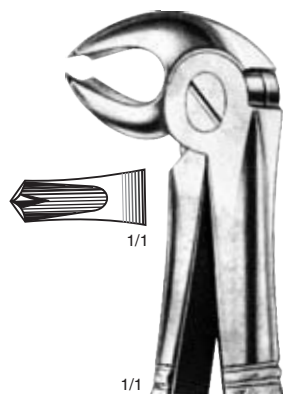

22
UI30-175-22
For Lower Molars-either side

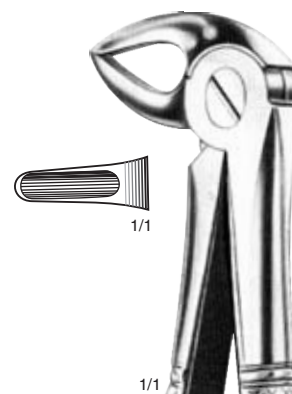

33
UI30-177-33
For Lower Roots-either side

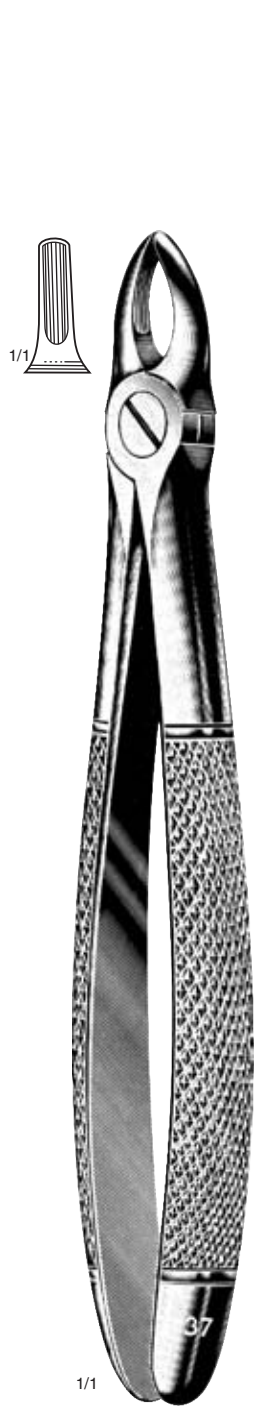
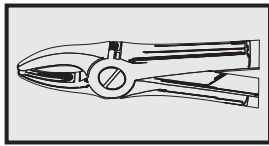

37
UI30-179-37
For Upper Incisors and Canines



13S
UI30-173-13
For Lower Bicuspids

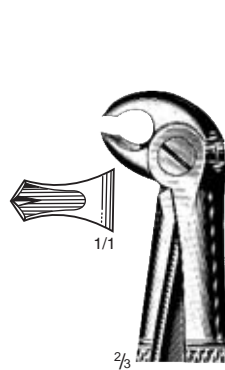

22S
UI30-181-22
For Lower Molars-either side

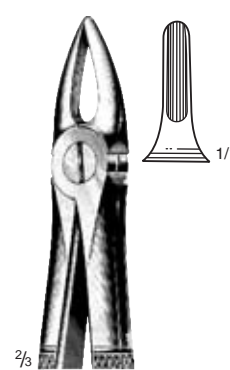

29S
UI30-183-29
For Upper Incisors and roots-either side

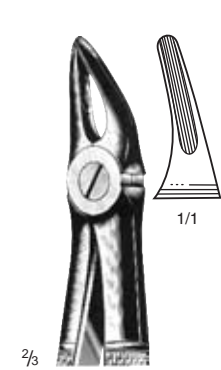

30S
UI30-185-30
For Upper Incisors and roots-either side

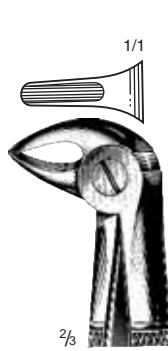

33S
UI30-187-33
For Lower roots-either side

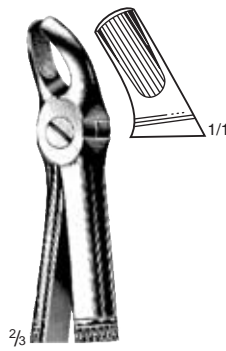

39
UI30-189-39
For Upper Molars-either side

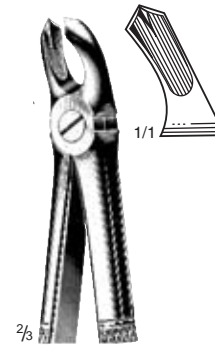

39A
UI30-191-39
For Upper Molars-either side

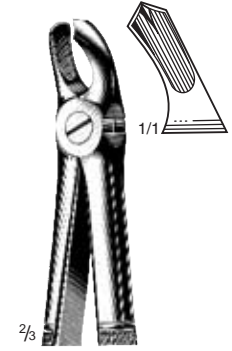

39L
UI30-193-39
For Left Upper Molars

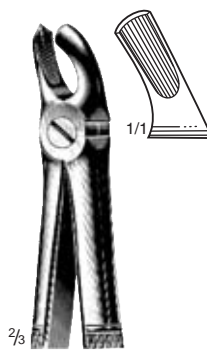

39R
UI30-195-39
For Right Upper Molars

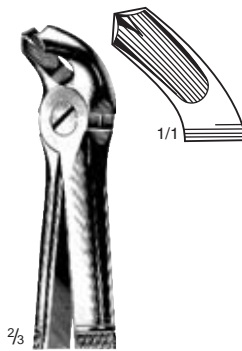

40
UI30-197-40
For Lower Molars-either side

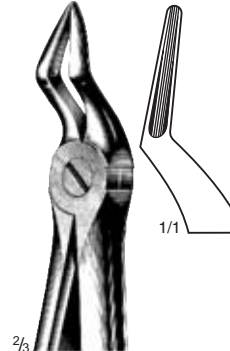

51S
UI30-199-51
For Upper Roots

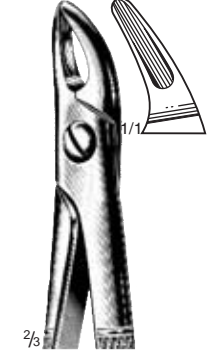

76S
UI30-201-76
For Upper Roots-either side

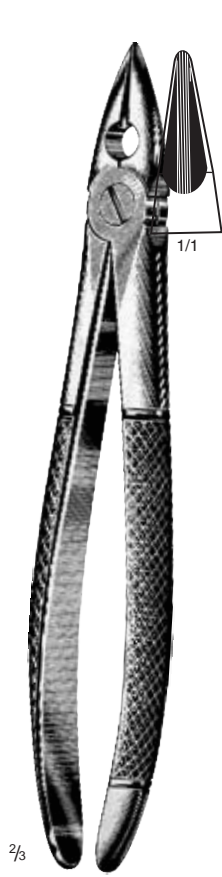
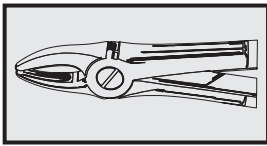

MD1
UI30-203-01
For Upper Wisdoms and Bicuspid
and upper Roots
Mead



MD2
UI30-205-02
For Upper Molars
Mead



MD3
UI30-207-03
For Lower Incisors Bicuspid
and Roots



MD4
UI30-209-04
For Lower Molars

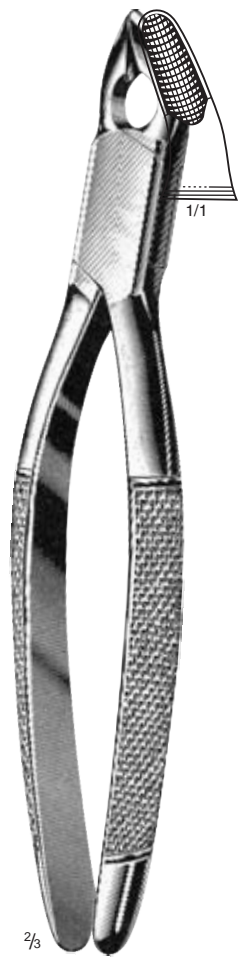

Cohen
UI30-211-00
Universal Forceps
American Pattern

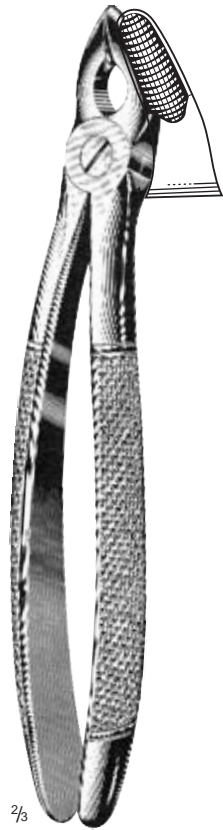

Cohen
UI30-213-00
Universal Forceps
English Pattern

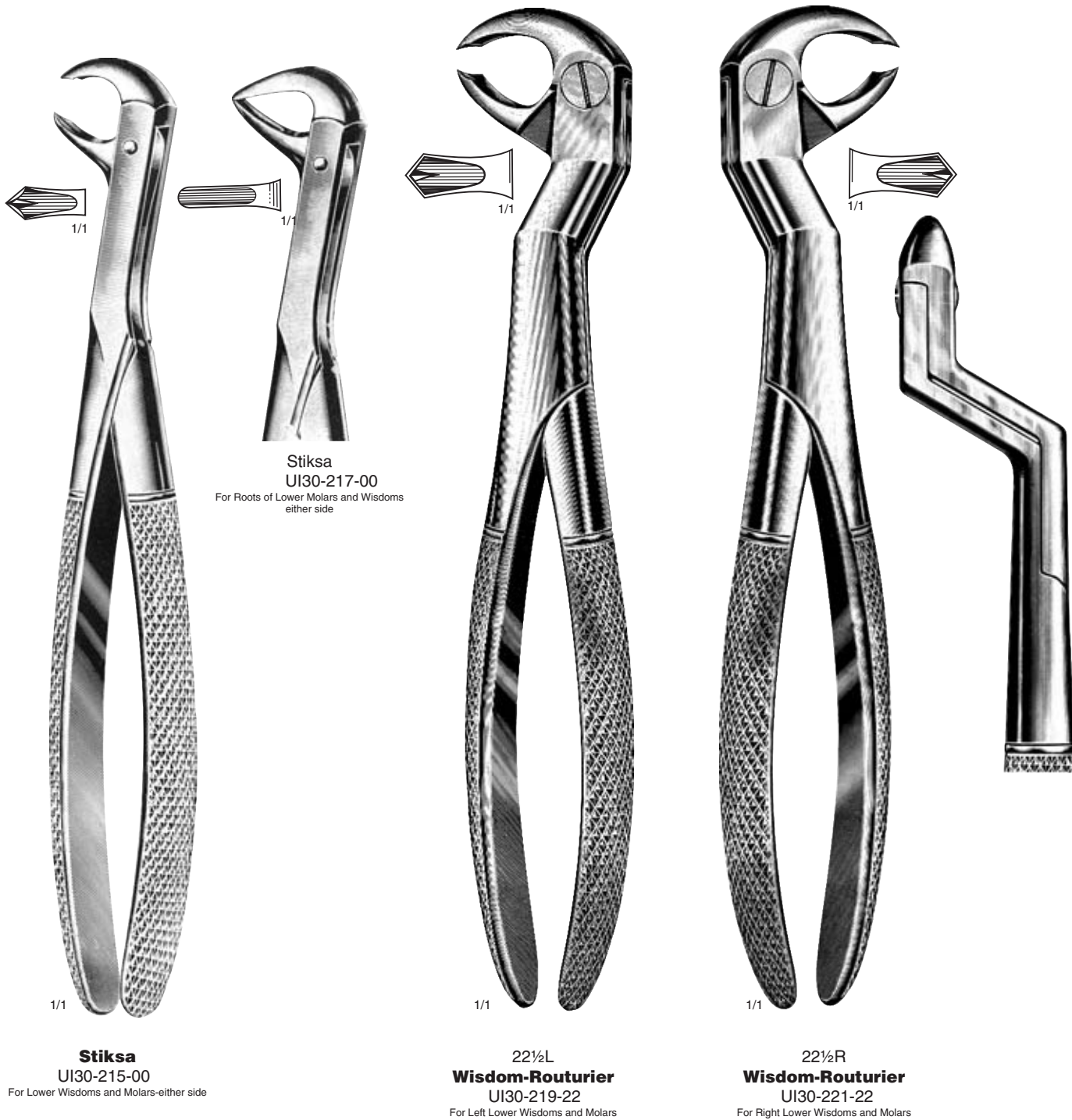
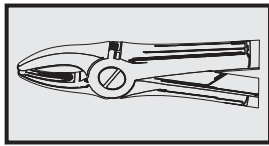

Stiksa
UI30-215-00
For Lower Wisdoms and Molars-either side

Stiksa
UI30-217-00
For Roots of Lower Molars and Wisdoms
either side

22½L
Wisdom-Routurier
UI30-219-22
For Left Lower Wisdoms and Molars

22½R
Wisdom-Routurier
UI30-221-22
For Right Lower Wisdoms and Molars

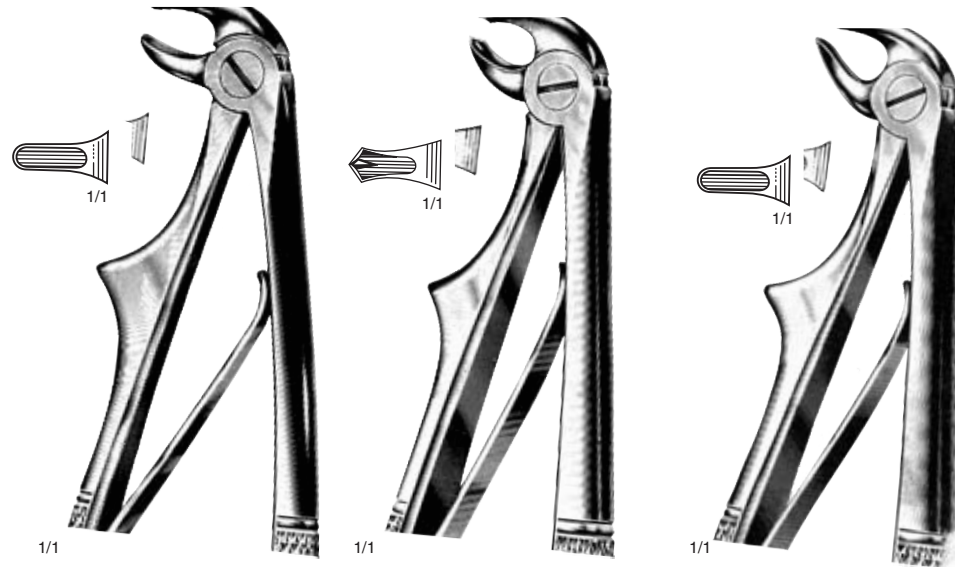
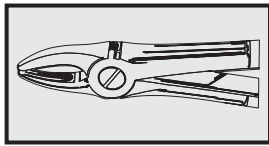

5
Klein
UI30-225-05
For Lower Incisors

6
Klein
UI30-227-06
For Lower Molars

7
Klein
UI30-229-07
For Lower Roots



3
Klein
UI30-223-03
For Upper Molars



137
Klein
UI30-231-37
For Upper Incisors and Canines



139
Klein
UI30-233-39
For Upper Bicuspids

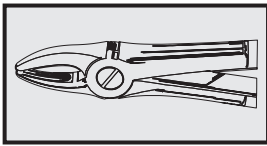

17SK
UI30-235-17
For Lower Molars-either side



23SK
UI30-237-23
For Lower Molars-either side

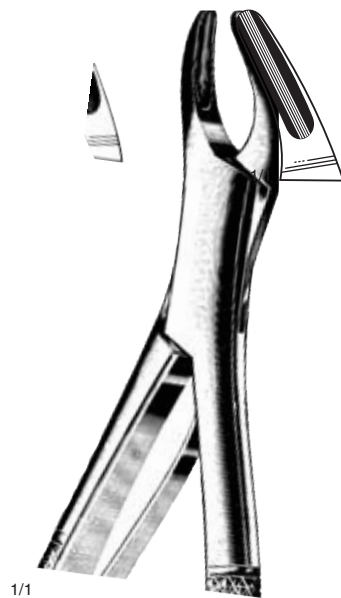

150SK
UI30-239-50
For Upper Teeth and Roots

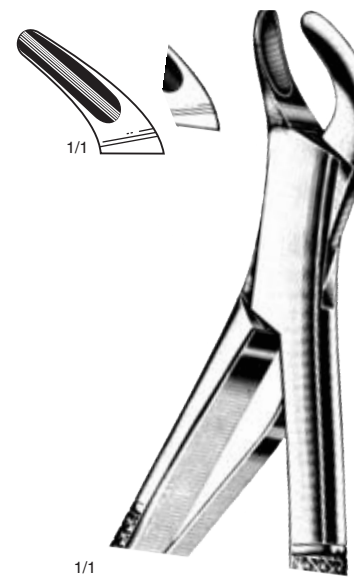

151SK
UI30-241-51
For Lower Teeth and Roots

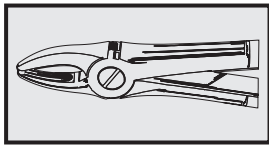

1
Standard
UI30-243-01
For Upper Central, Laterals and Cuspids

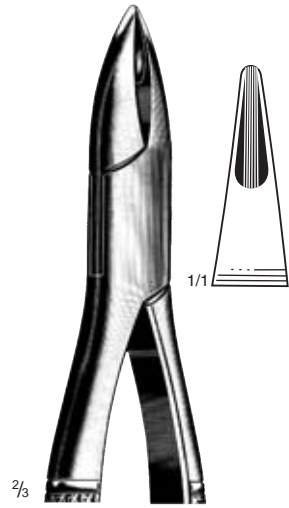

1A
Henahan
UI30-245-11
For Upper Incisors

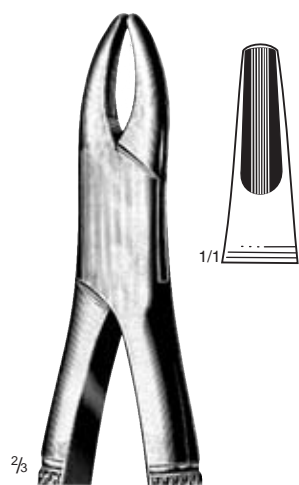

1B
Normal
UI30-249-12
For Upper Front Roots

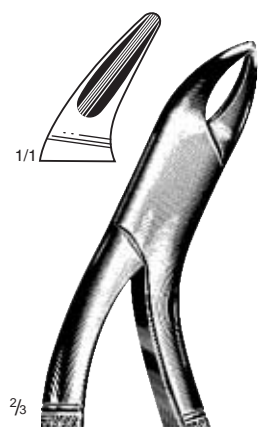

3
Milwaukee
UI30-247-03
For Lower Bicuspids

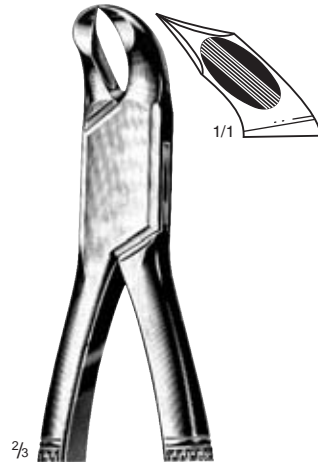

3FS
Woodward
UI30-251-03
For Lower Molars for
straight handles



3FH
Woodward
UI30-253-03
For Lower Molars with
hooked handles

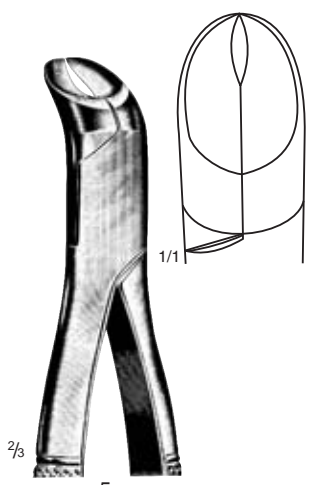

5
Physick
UI30-255-05
For Lower Third
Molars-either side

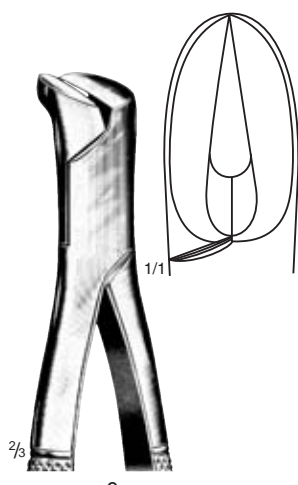

6
UI30-257-06
Splitting or Separating Forceps

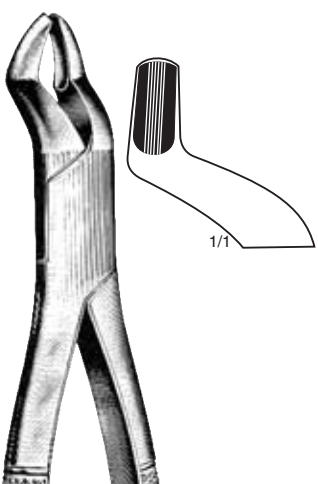

10H
UI30-259-10
For Upper Molars with
hooked Handles

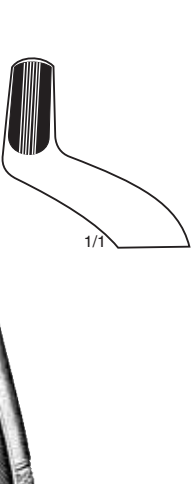

10S
UI30-261-10
For Upper Molars with
straight handles

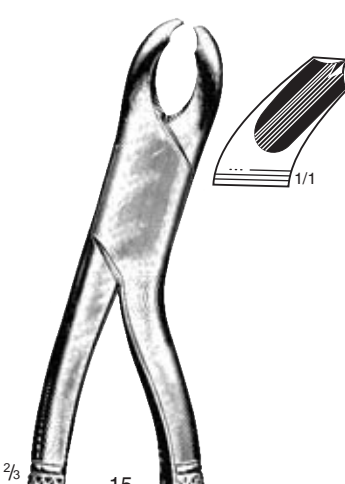

15
Harris
UI30-263-15
For Lower Molars for either-side
with hooked handles

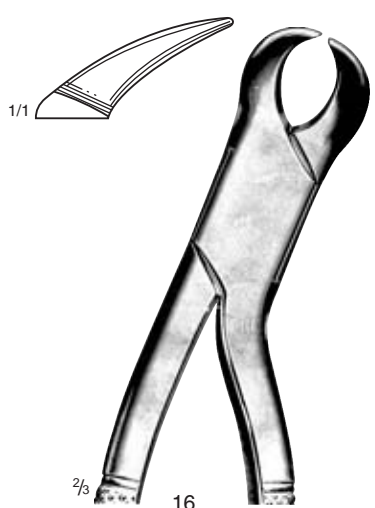

16
UI30-265-16
For Lower Molars

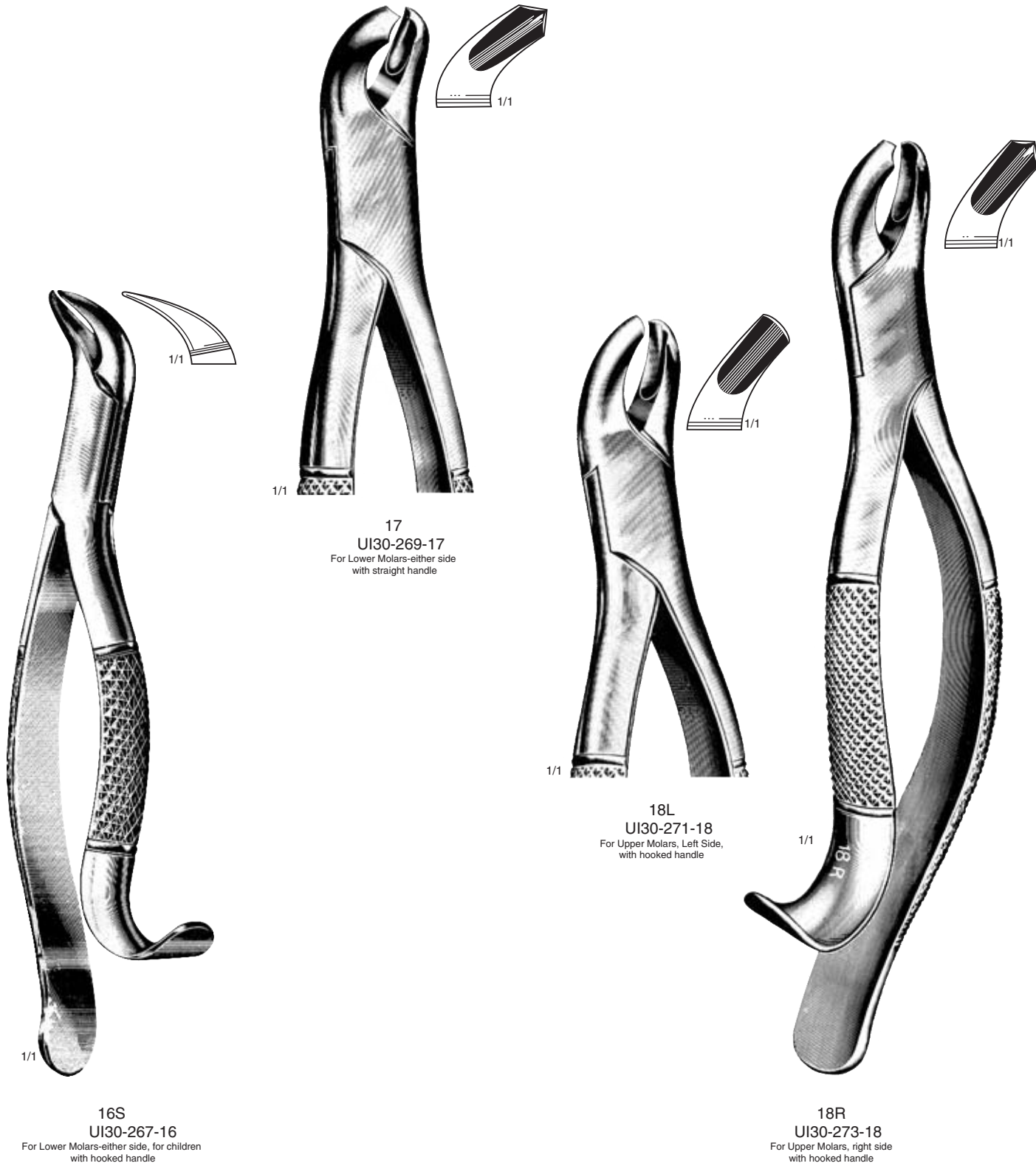
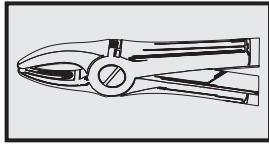

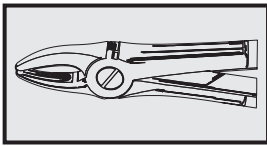

23
UI30-275-23
For Lower Molars-either side
with straight handle

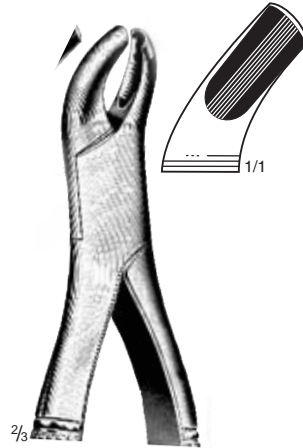

24
UI30-277-24
For Upper Molars-either side
hooked handle

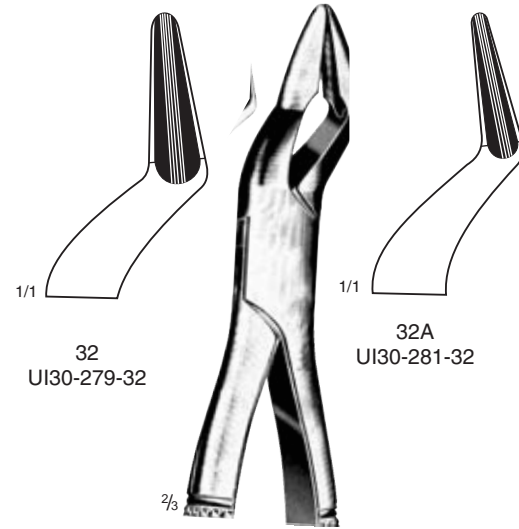

32
UI30-279-32

32A
UI30-281-32

32
UI30-279-32
For Upper Molars and Bicuspid
with straight handle

32A
Parmly
UI30-281-32
For Upper Molars and Bicuspid
with straight handle

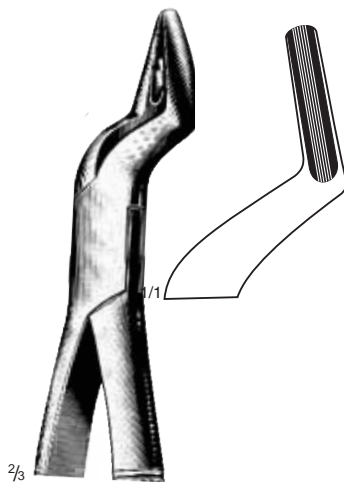

35
UI30-283-35
For Upper Roots-either side
with straight handle

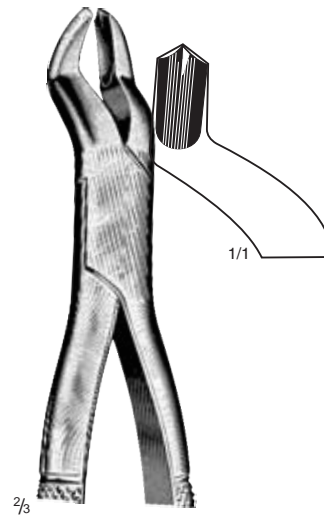

53L
UI30-285-53
For Upper Molars, Left side, with
straight handle

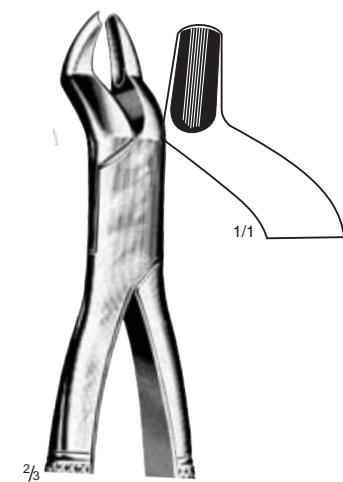

53R
UI30-287-53
For Upper Molars, right side, with
straight handle

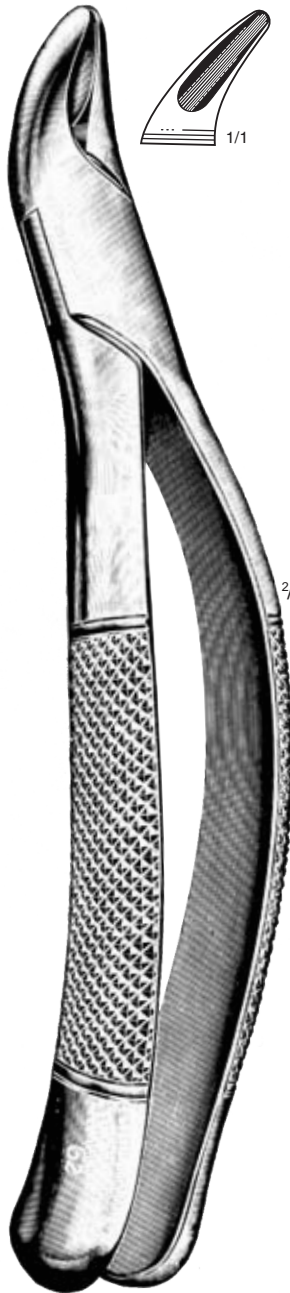
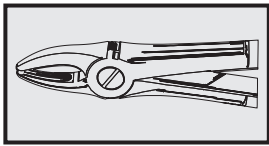

1/1

62
UI30-289-62
Universal Forceps, For Upper Teeth and Roots,
For Children, straight handle



1/1

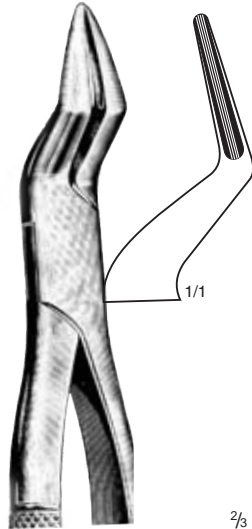

1/1

65
UI30-291-65
For Upper Incisors and Roots
Straight handle

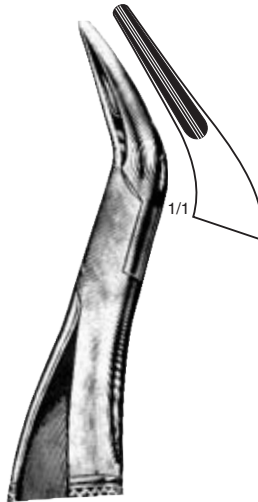

1/1

69
UI30-293-69
For Fragments and Small Roots, upper
and lower straight handle

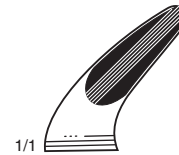

1/1

85
UI30-295-85
For Lower Molars, Cuspids
and Bicusps
with hooked handle



1/1

85A
UI30-297-85
For Lower Molars, Cuspids
and Bicusps
with hooked handle

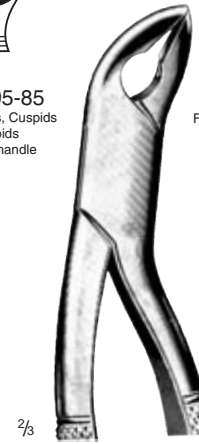

2/3

Thomas

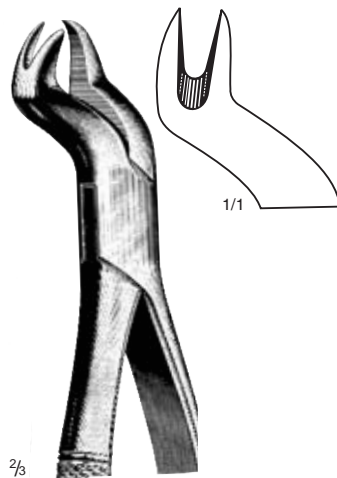

1/1

88L
UI30-299-88
For Left Upper Molars, with
straight handle

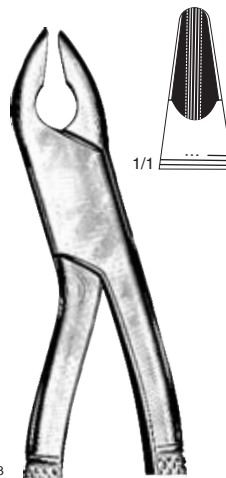

1/1

99A
Kells
UI30-301-99
For Upper Bicusps, and Incisors
with hooked handle

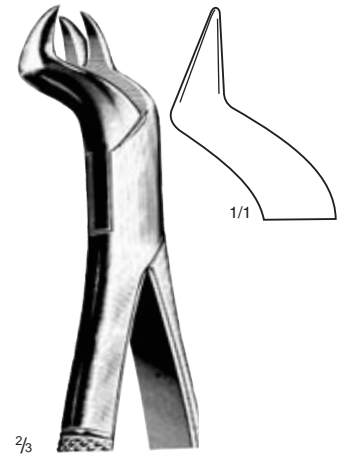

1/1

88R
UI30-303-88
For Right Upper Molars, with
straight handle

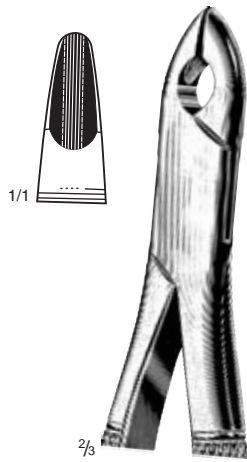
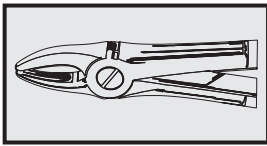

**99C
Kells**
UI30-305-99
For Upper Bicusps, and Incisors
with straight handle

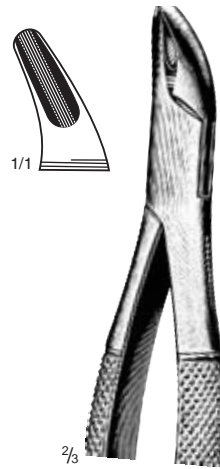

**101
Hull**
UI30-307-101
Universal Forceps for Bicusps,
and Milk-Teeth, straight handle

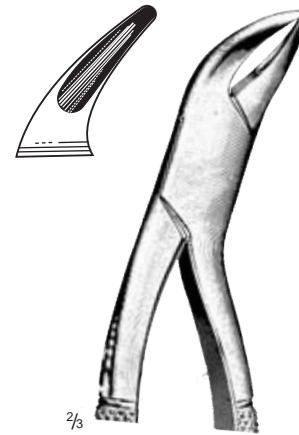

103
UI30-309-03
For Lower Bicusps, Incisors and Roots-either
side hooked handle

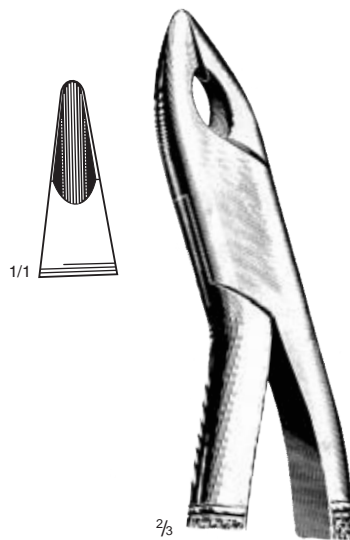

**110
Nevius**
UI30-311-10
For Upper Bicusps and Cuspids
with hooked handle

UI30-313-01
For Upper Bicusps and Cuspids
with straight handle

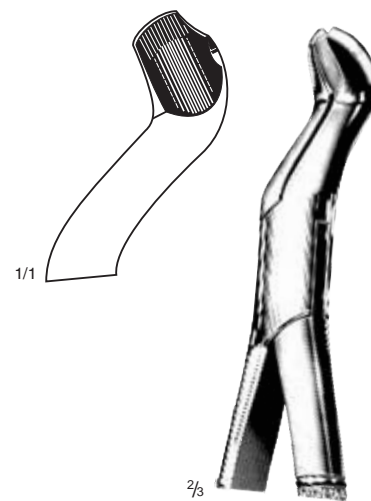

**121
Felsch**
UI30-315-21
For Upper Wisdoms with
straight handle

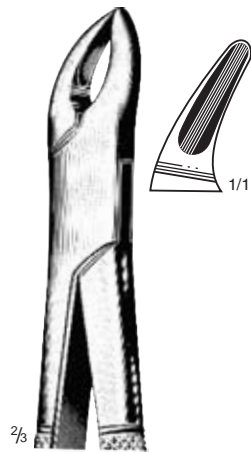
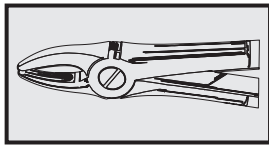

**150
Cryer**
UI30-317-50
For Upper Bicuspids Incisors and
Roots with straight handles

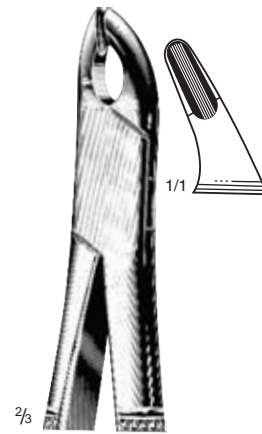

**150A
Cryer**
UI30-319-50
For Upper Bicuspids Incisors and
Roots with straight handle

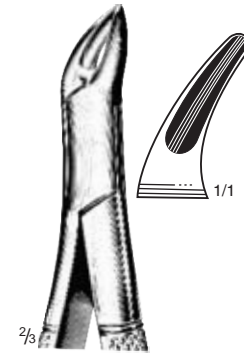

**150S
Cryer**
UI30-321-50
For Upper Bicuspids Incisors and
Roots with straight handle

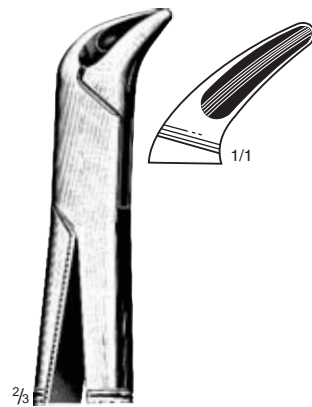

**151
Cryer**
UI30-323-51
For Upper Bicuspids Incisors and
Roots with straight handle

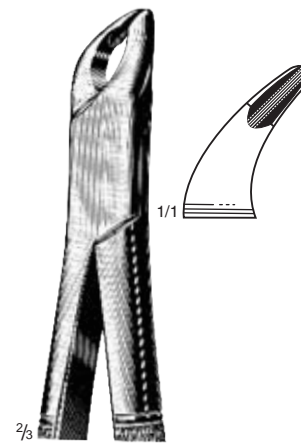

**151A
Cryer**
UI30-325-51
For Upper Bicuspids Incisors and
Roots with straight handle

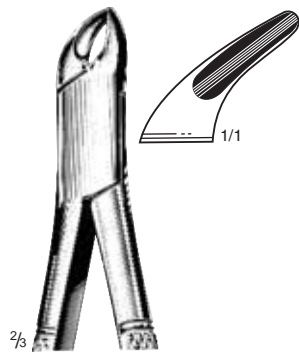
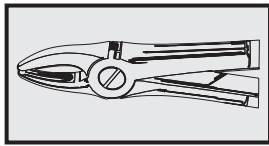

**151S
Cryer**
UI30-327-51
For Lower Bicuspid Incisors and
Roots with straight handle

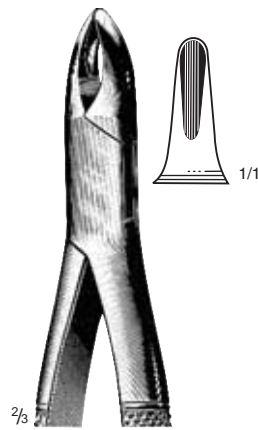

201
UI30-329-01
For Upper Bicuspid Cuspids and Incisors
with straight handle

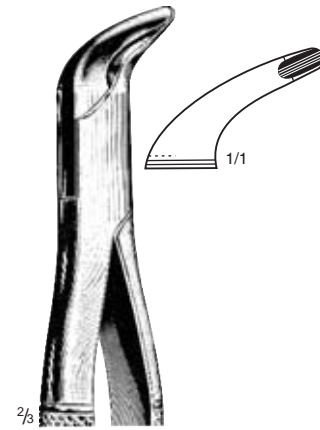

203
UI30-331-03
For Lower Bicuspid and Roots Incisors
with straight handle

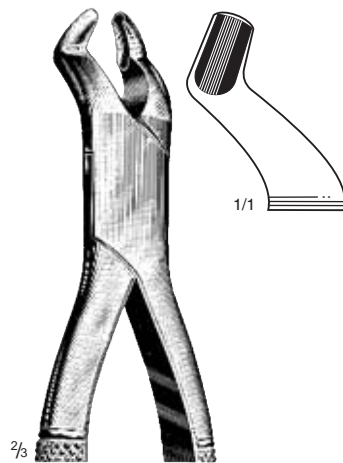

210H
UI30-333-10
For Upper Wisdoms-either side
with hooked handle

210S
UI30-335-10
For Upper Wisdoms-either side
with straight handle

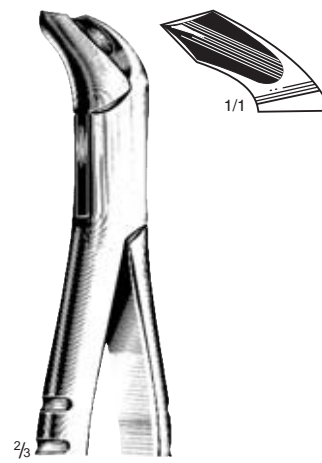

217
UI30-337-17
For Lower Molars-either side
with straight handle

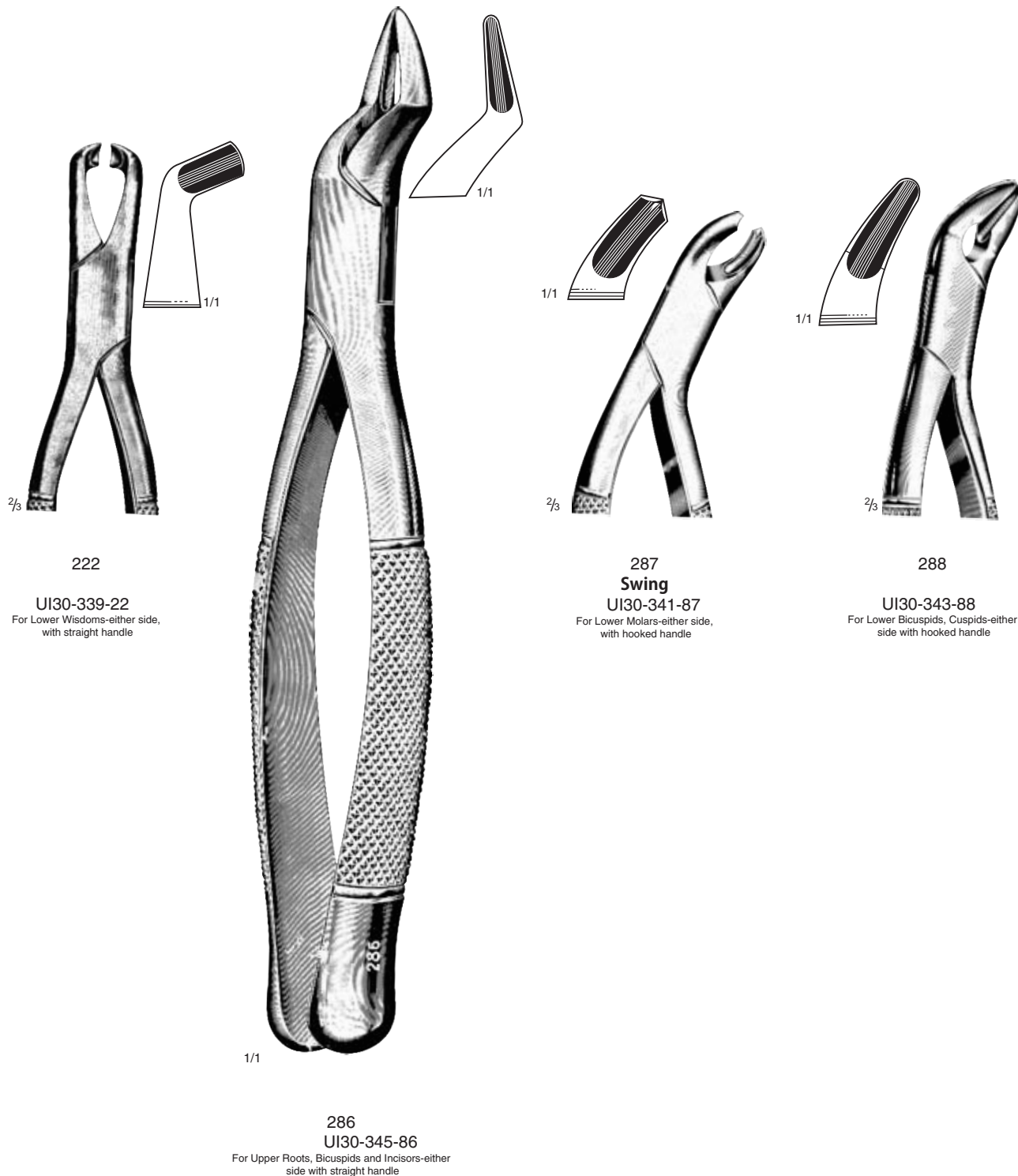
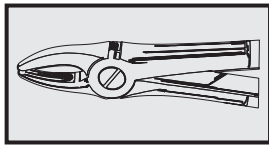

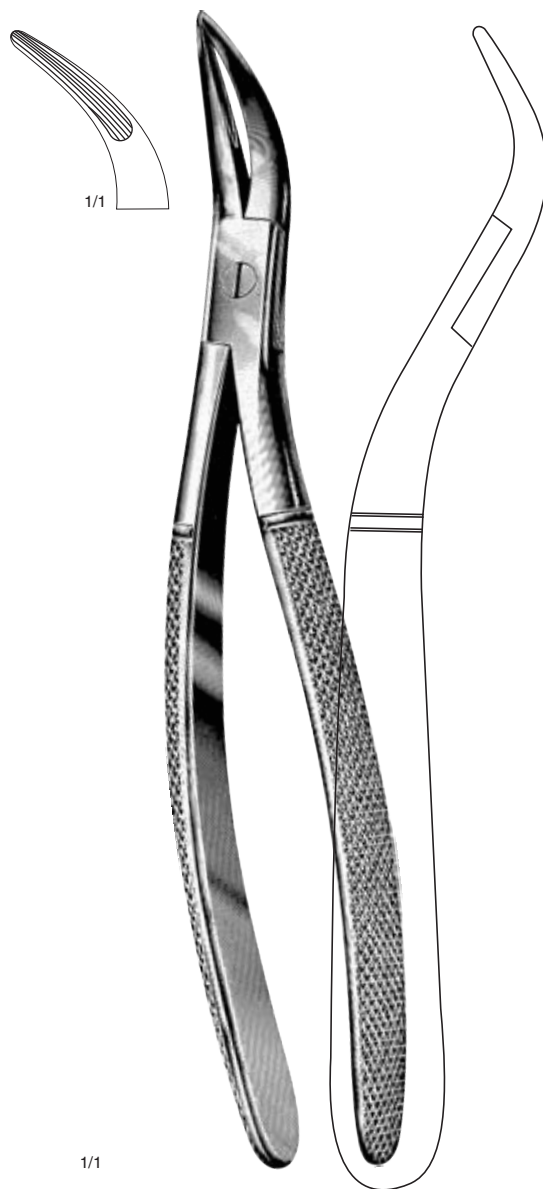
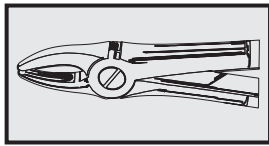

Witzel
UI30-347-00
Universal Pattern for Upper Teeth

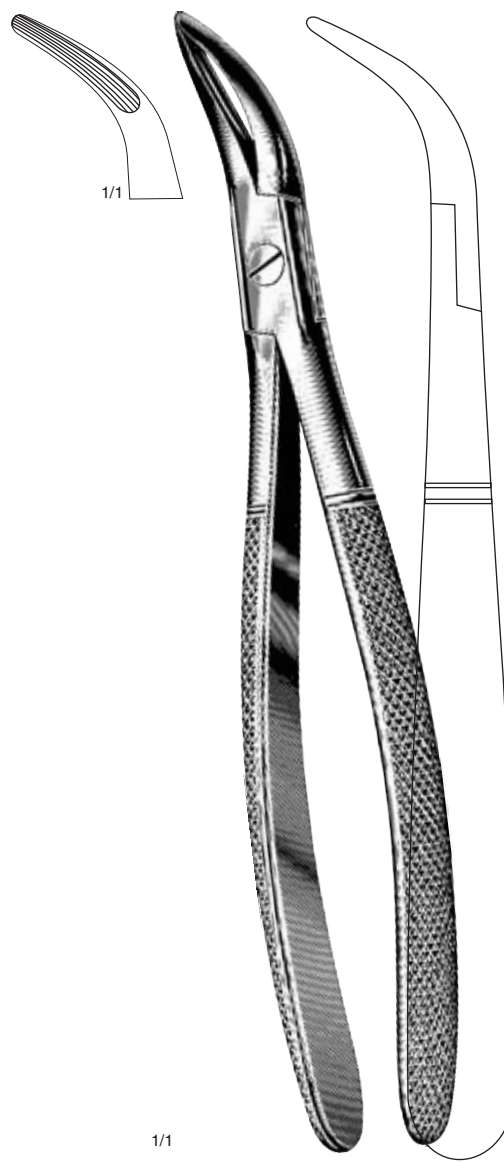

Witzel
UI30-349-00
Universal Pattern for Upper Teeth

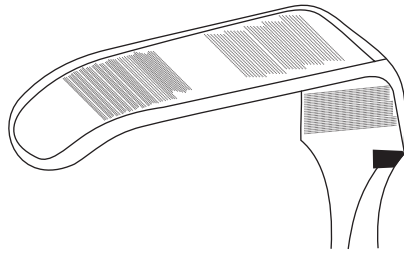

7

RETRACTORS

 URIYA Instruments®



MOBILE : +61 402 764 684 / +923126505109
E-MAIL : info@uriyainstruments.com

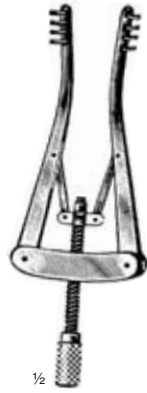
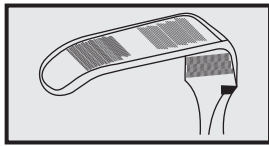

Alm

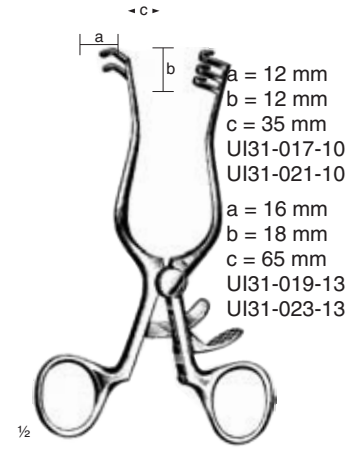
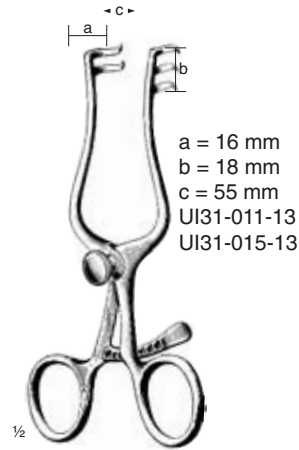
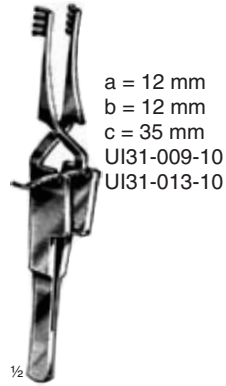

cm	in	Sharp	Blunt	Sharp	Blunt	Sharp	Blunt	Sharp	Blunt
7	2¾	UI31-001-07	UI31-003-07						
10	4	UI31-001-10	UI31-003-10	UI31-005-10	UI31-007-10	UI31-009-10	UI31-013-10	UI31-017-10	UI31-021-10
13	5					UI31-011-13	UI31-015-13	UI31-019-13	UI31-023-13

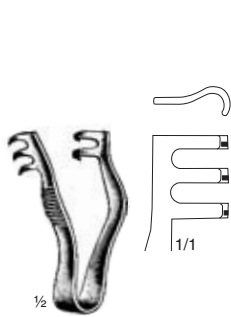

Finsen

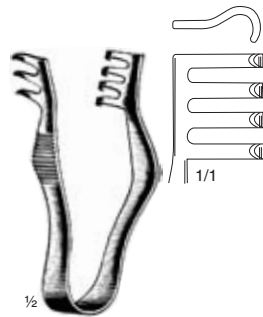

Finsen

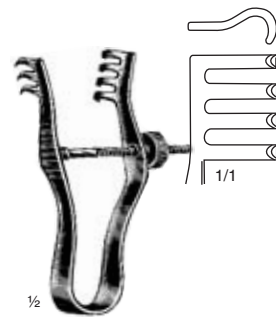

Finsen

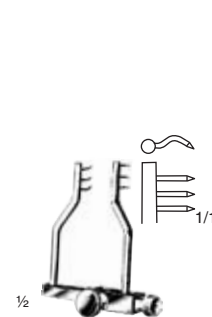

Logan

Sharp	Blunt	Sharp	Blunt	Sharp	Blunt	Sharp
5 cm / 2"	5 cm / 2"	7 cm / 2¾"	7 cm / 2¾"	7 cm / 2¾"	7 cm / 2¾"	4 cm / 1½"
UI31-025-05	UI31-027-05	UI31-029-07	UI31-031-07	UI31-033-07	UI31-035-07	UI31-037-04

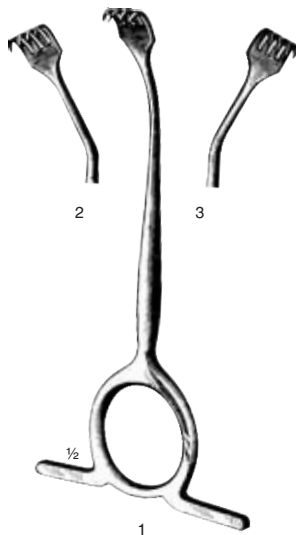

Williger



1	UI31-039-03	UI31-045-04	UI31-051-03	UI31-057-04
2	UI31-041-03	UI31-047-04	UI31-053-03	UI31-059-04
3	UI31-043-03	UI31-049-04	UI31-055-03	UI31-061-04

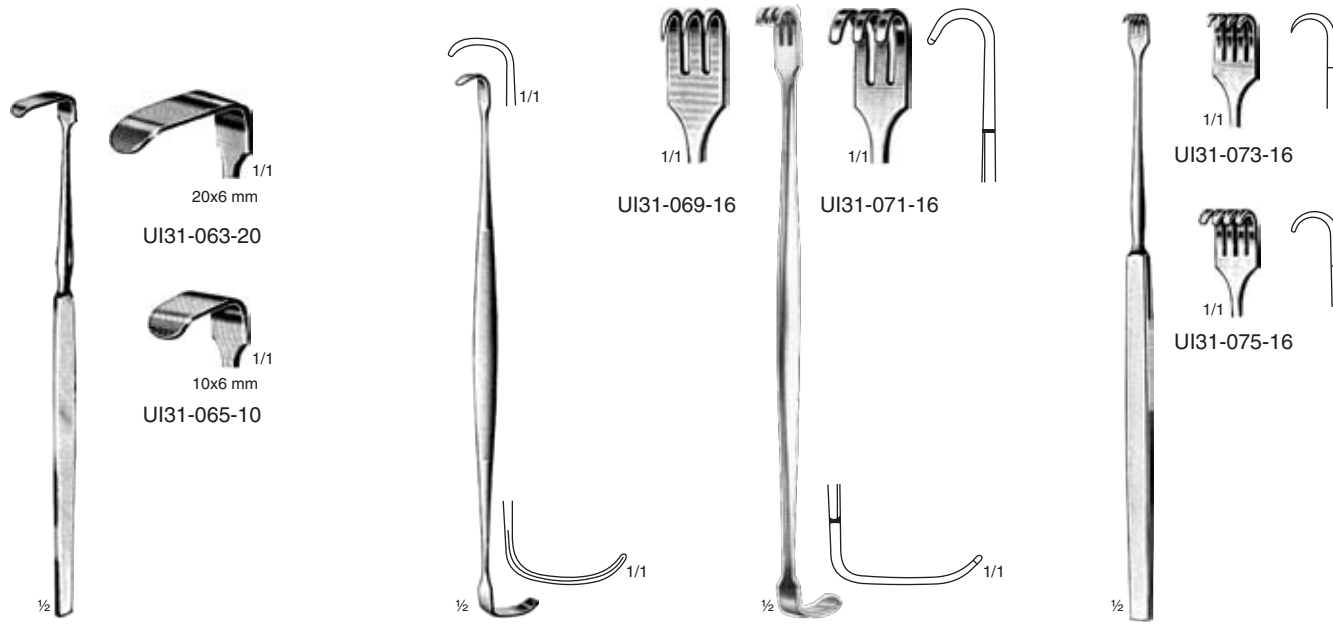
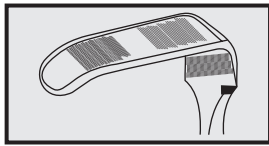

Senn-Green
15 cm / 6"

Ragnell-Davis
14 cm / 5½"
UI31-067-14

Senn-Mueller
16 cm / 6¼"

Klapp
16 cm / 6¼"

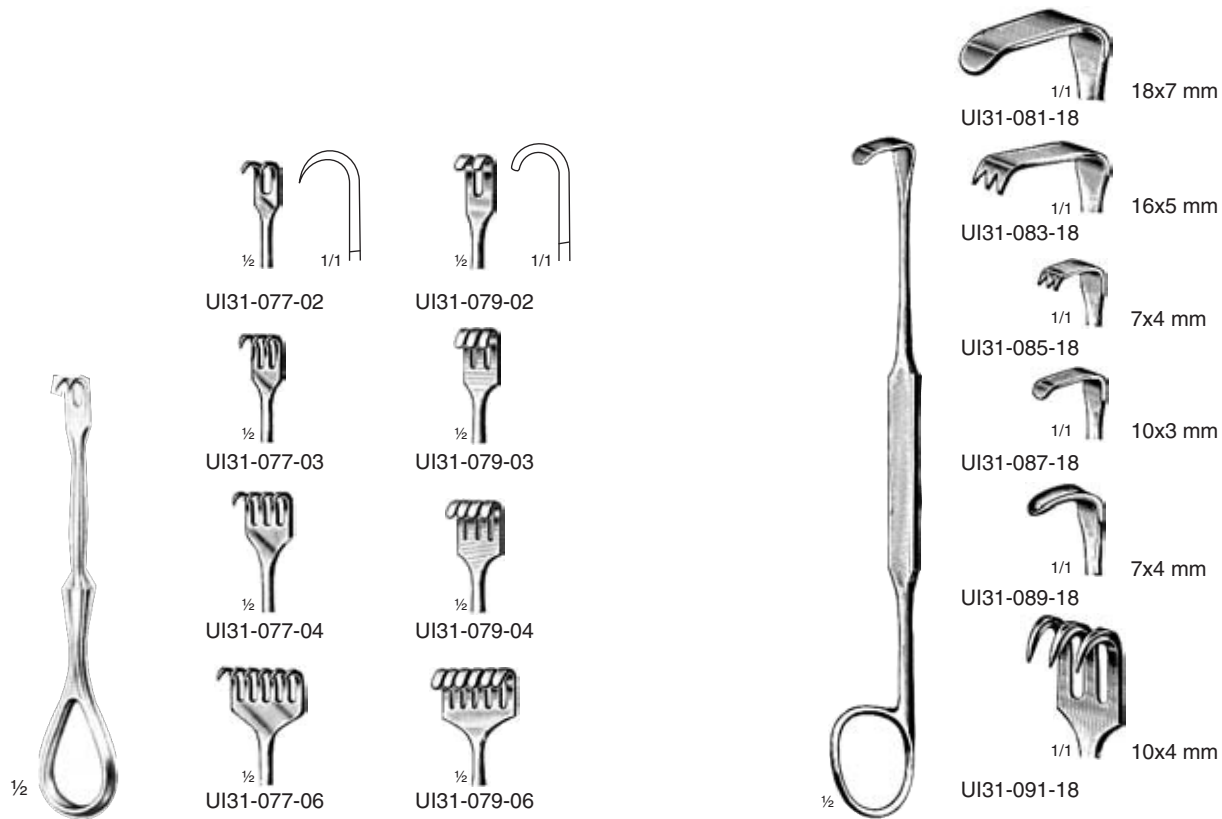

Volkmann
11.5 cm / 4½"

Meyerding
18 cm / 7"

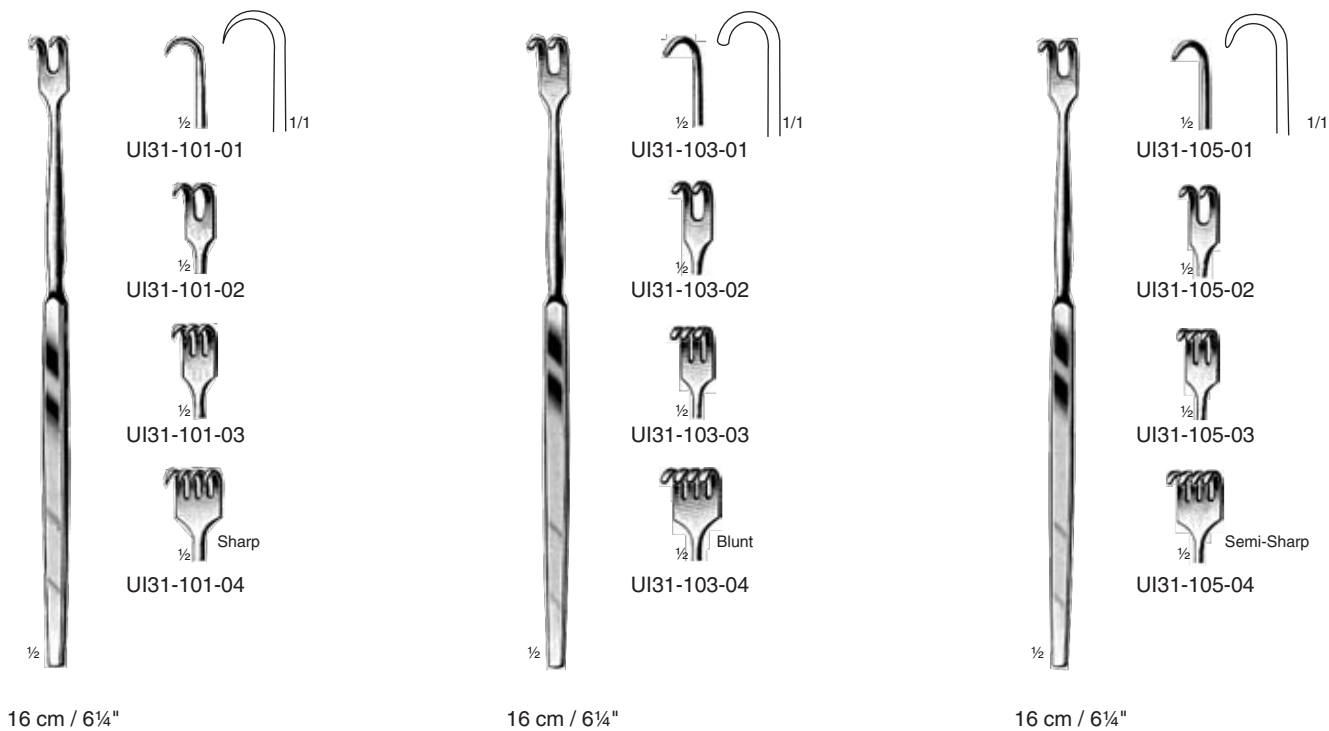
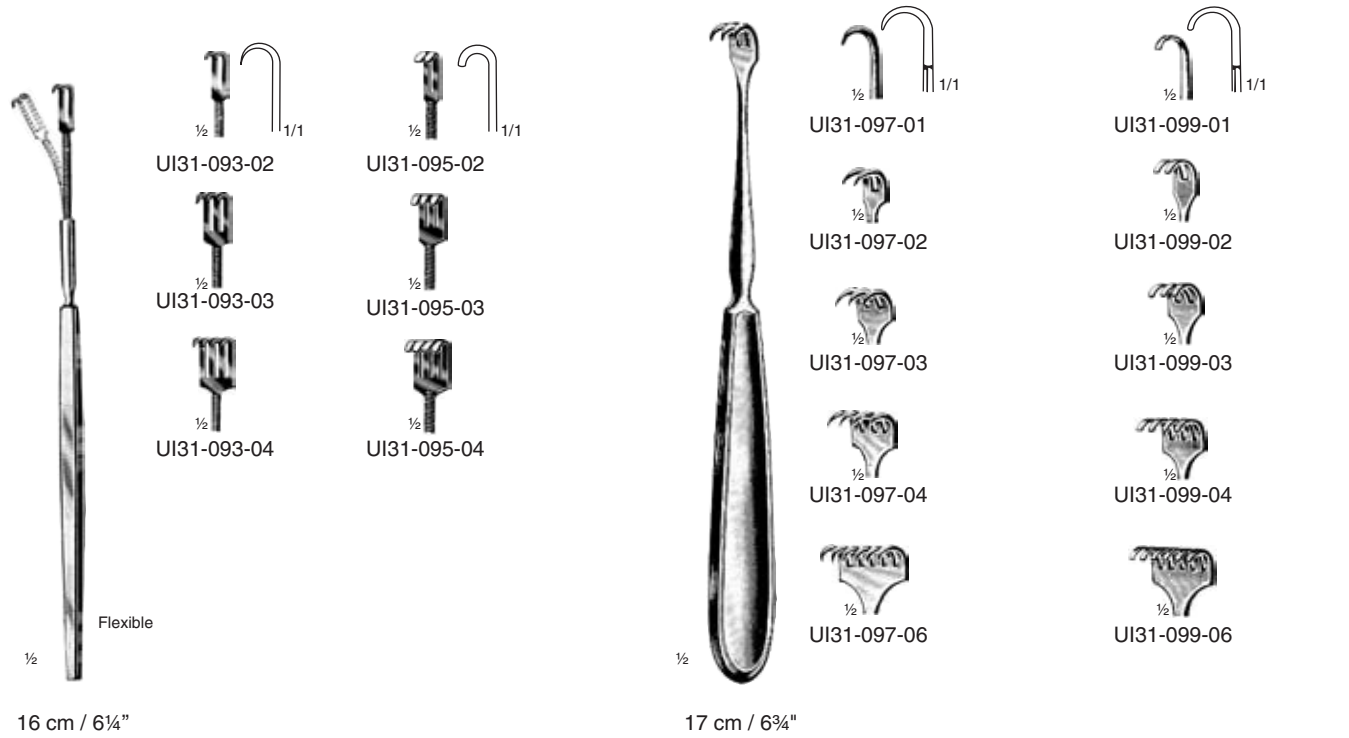
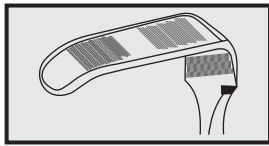

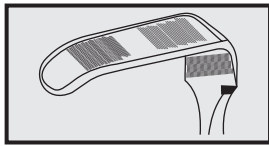

½

Langenbeck
21 cm / 8¼"
UI31-107-00

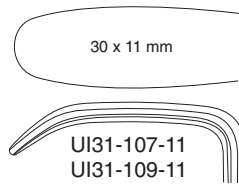

30 x 11 mm

UI31-107-11
UI31-109-11

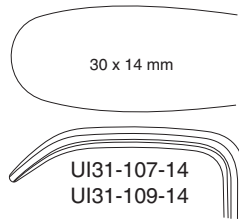

30 x 14 mm

UI31-107-14
UI31-109-14

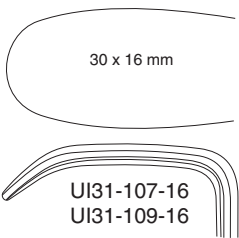

30 x 16 mm

UI31-107-16
UI31-109-16

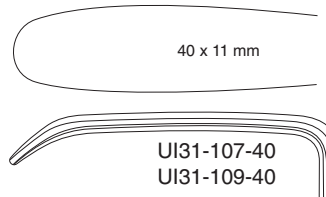

40 x 11 mm

UI31-107-40
UI31-109-40



½

Langenbeck
21 cm / 8¼"

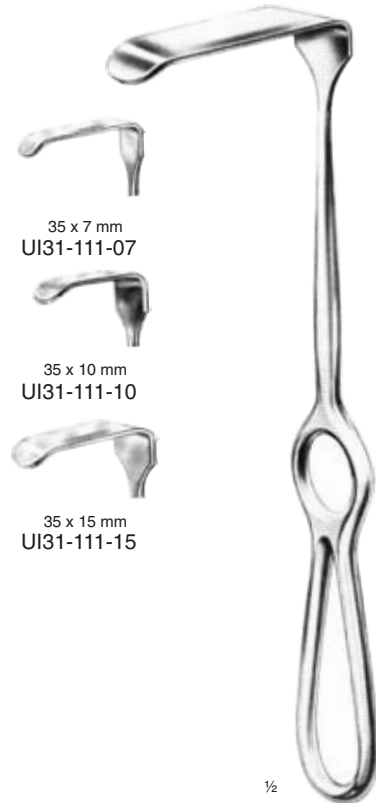

½

Langenbeck
22 cm / 8½"
UI31-111-22



35 x 7 mm
UI31-111-07



35 x 10 mm
UI31-111-10



35 x 15 mm
UI31-111-15



½

20 cm / 8"



25 x 6 mm
UI31-113-25



40 x 10 mm
UI31-113-40



69 x 11 mm
UI31-113-69



½

20 cm / 8"



40 x 12 mm
UI31-115-40



60 x 11 mm
UI31-115-60

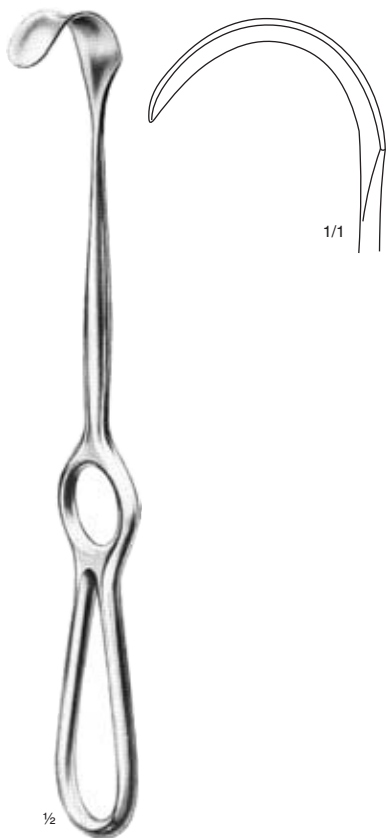
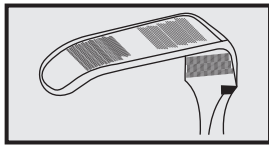

Kocher
22 cm / 8 3/4"
40 x 10 mm
UI31-117-10
40 x 15 mm
UI31-119-15

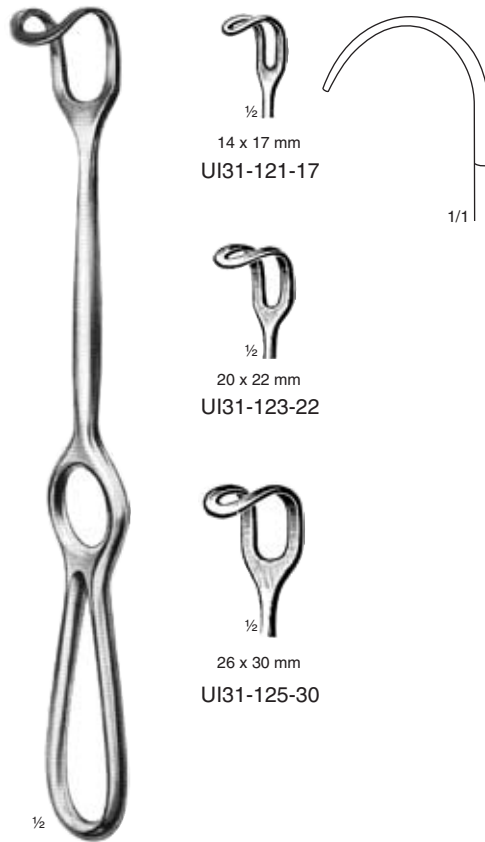

Middeldorpf

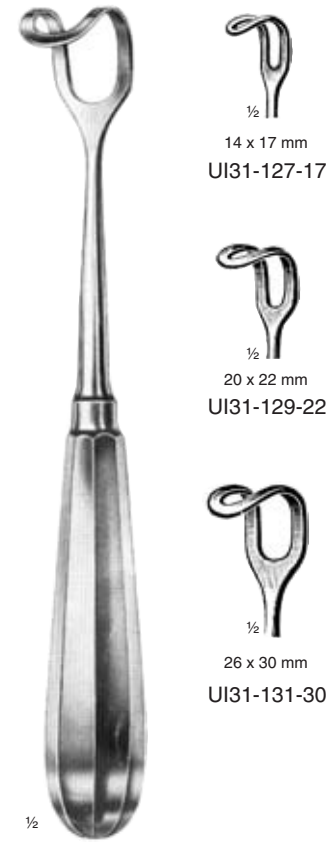
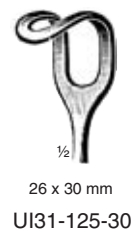
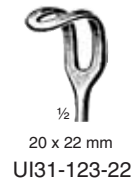
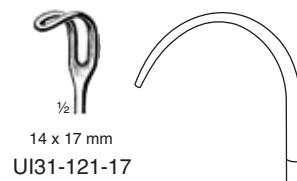

Middeldorpf

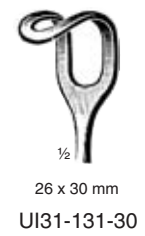
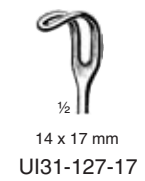

UI31-133-01



UI31-135-01



Shann
UI31-137-01

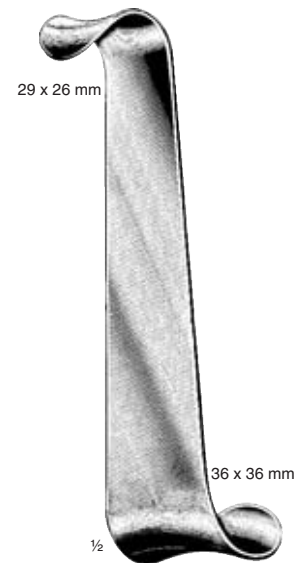

Roux Magnus
UI31-139-01

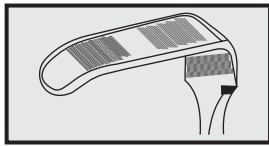

UI31-141-01 # 1
25 x 6 mm



UI31-141-05 # 5
35 x 15 mm



UI31-141-02 # 2
25 x 8 mm



UI31-141-06 # 6
40 x 11 mm



UI31-141-03 # 3
35 x 8 mm



UI31-141-07 # 7
55 x 11 mm



¼ UI31-141-04 # 4
35 x 11 mm



UI31-141-08 # 8
70 x 14 mm



UI31-141-09 # 9
80 x 12 mm



¼ UI31-141-10 # 10
80 x 16 mm



½
Kocher-Langenbeck
21.5cm/8 ½"

also available in special sizes

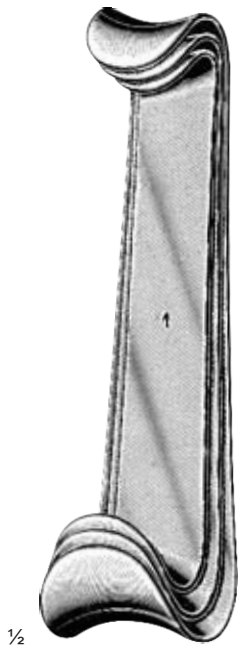
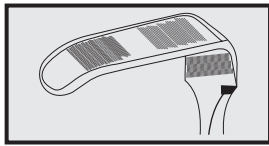

1/2

Fig. 1 = 24 X 20 mm
 Fig. 2 = 29 X 26 mm
 Fig. 3 = 35 X 29 mm
 Fig. 4 = 27 X 24 mm

Fig. 1 = 30 X 28 mm
 Fig. 2 = 36 X 36 mm
 Fig. 3 = 38 X 43 mm
 Fig. 4 = 42 X 28 mm

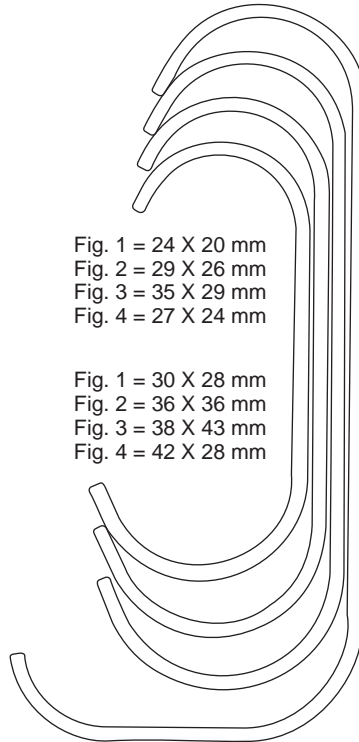

Roux

UI31-143-00 = Set Fig. 1-3
 UI31-143-01 = Fig. 1 = 14 cm/5 1/2"
 UI31-143-02 = Fig. 2 = 15 cm/6"
 UI31-143-03 = Fig. 3 = 17 cm/6 3/4"
 UI31-143-04 = Fig. 4 = 18 cm/7"

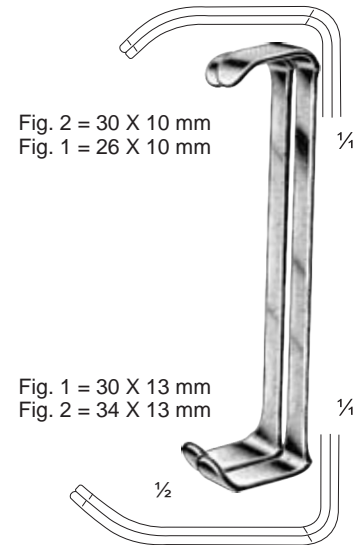

Fig. 2 = 30 X 10 mm
 Fig. 1 = 26 X 10 mm

Fig. 1 = 30 X 13 mm
 Fig. 2 = 34 X 13 mm

Farabeuf

UI31-145-00 = Set
 UI31-145-01 = Fig. 1
 UI31-145-02 = Fig. 2
 12 cm/4 3/4"

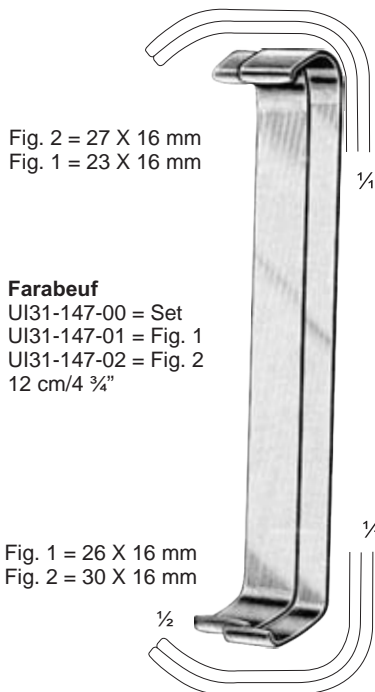
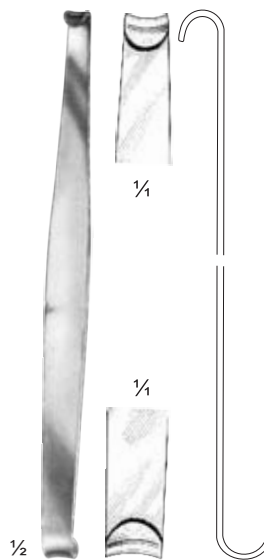

Fig. 2 = 27 X 16 mm
 Fig. 1 = 23 X 16 mm

Farabeuf

UI31-147-00 = Set
 UI31-147-01 = Fig. 1
 UI31-147-02 = Fig. 2
 12 cm/4 3/4"

Fig. 1 = 26 X 16 mm
 Fig. 2 = 30 X 16 mm



Mini-Roux
 UI31-149-06

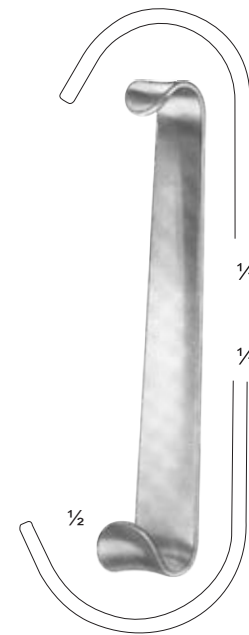

Baby-Roux
 UI31-151-13
 13 cm/5 1/4"

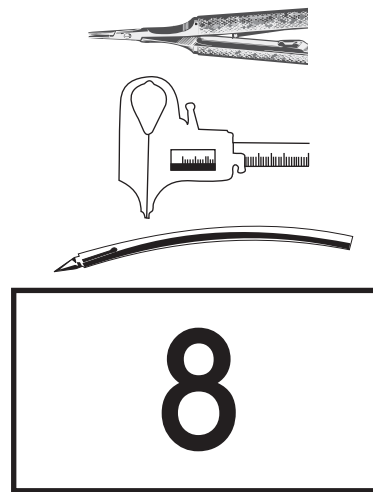

SUTURES, SUCTION TUBES &
MEASURING TOOLS

 URIYA Instruments®

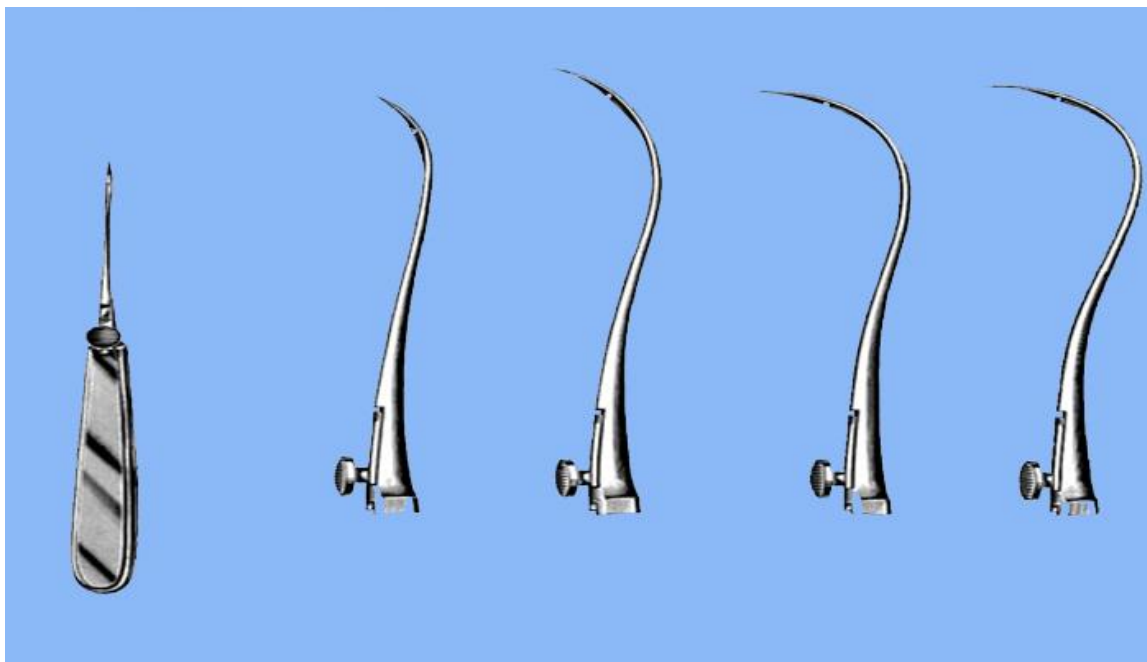

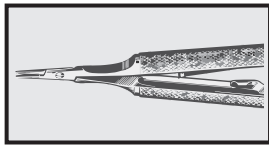

Reverdin

Reverdin

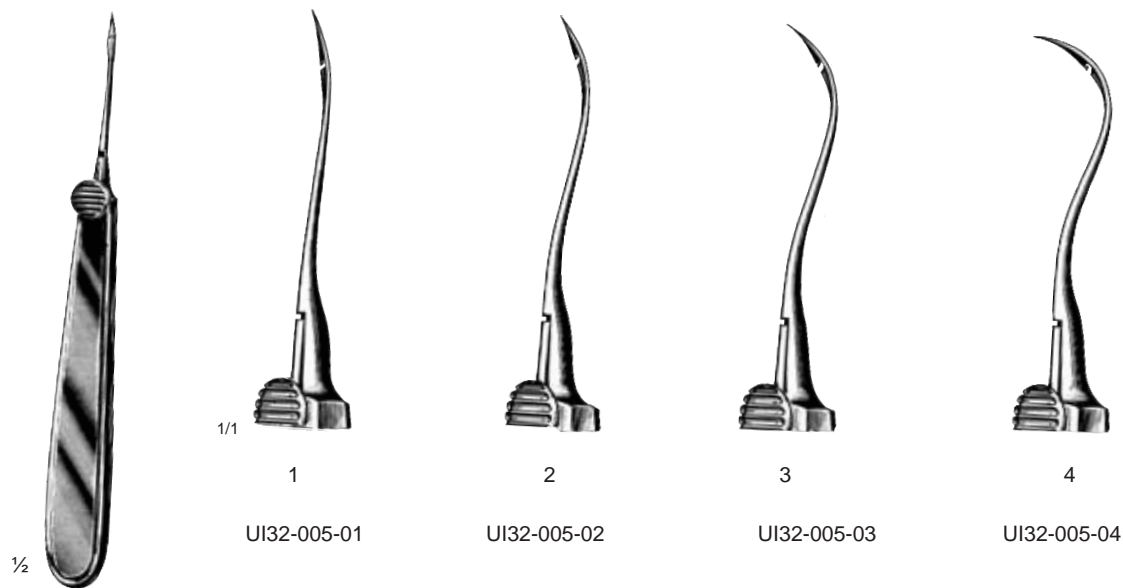

Reverdin
14 cm / 5¹/₂"

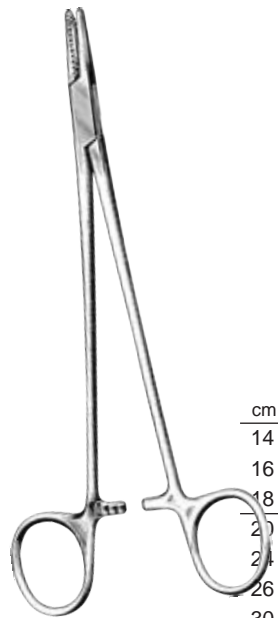
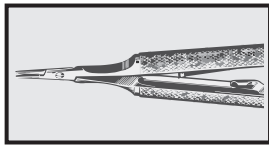

Mayo-Hegar

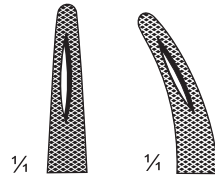

cm	in.	straight	curved
14	5 ½	UI32-007-14	
16	6 ¼	UI32-007-16	UI32-009-16
18	7	UI32-007-18	UI32-009-18
20	8	UI32-007-20	UI32-009-20
24	9 ½	UI32-007-24	UI32-009-24
26	10 ¼	UI32-007-26	UI32-009-26
30	12	UI32-007-30	

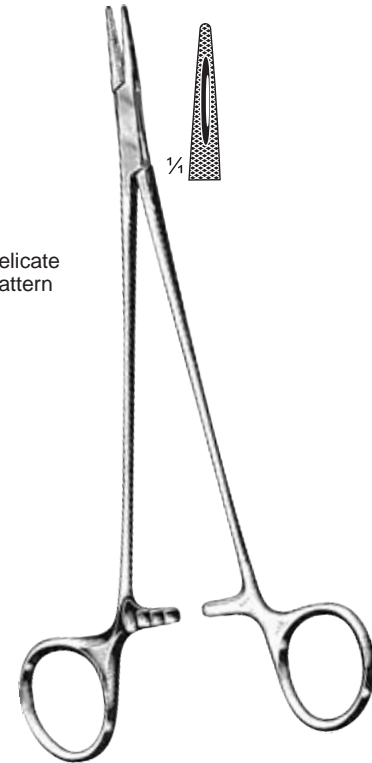

delicate pattern

Mayo-Hegar

UI32-011-16 = 16cm/6 ¼"
 UI32-011-18 = 18cm/7"
 UI32-011-20 = 30cm/8"

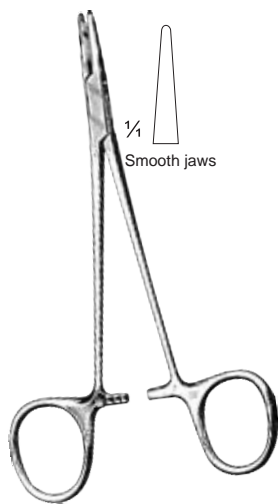

½

Halsey
 UI32-013-13
 13 cm / 5"

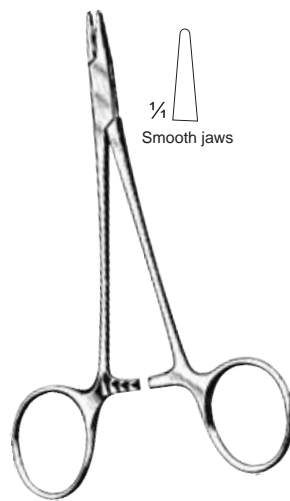

½

Webster
 UI32-015-13
 13 cm / 5"

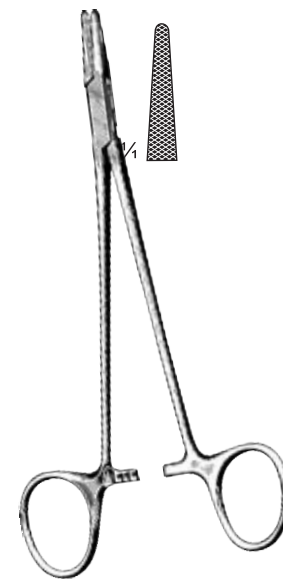

Crile-Murray
 UI32-017-15
 15 cm / 6"

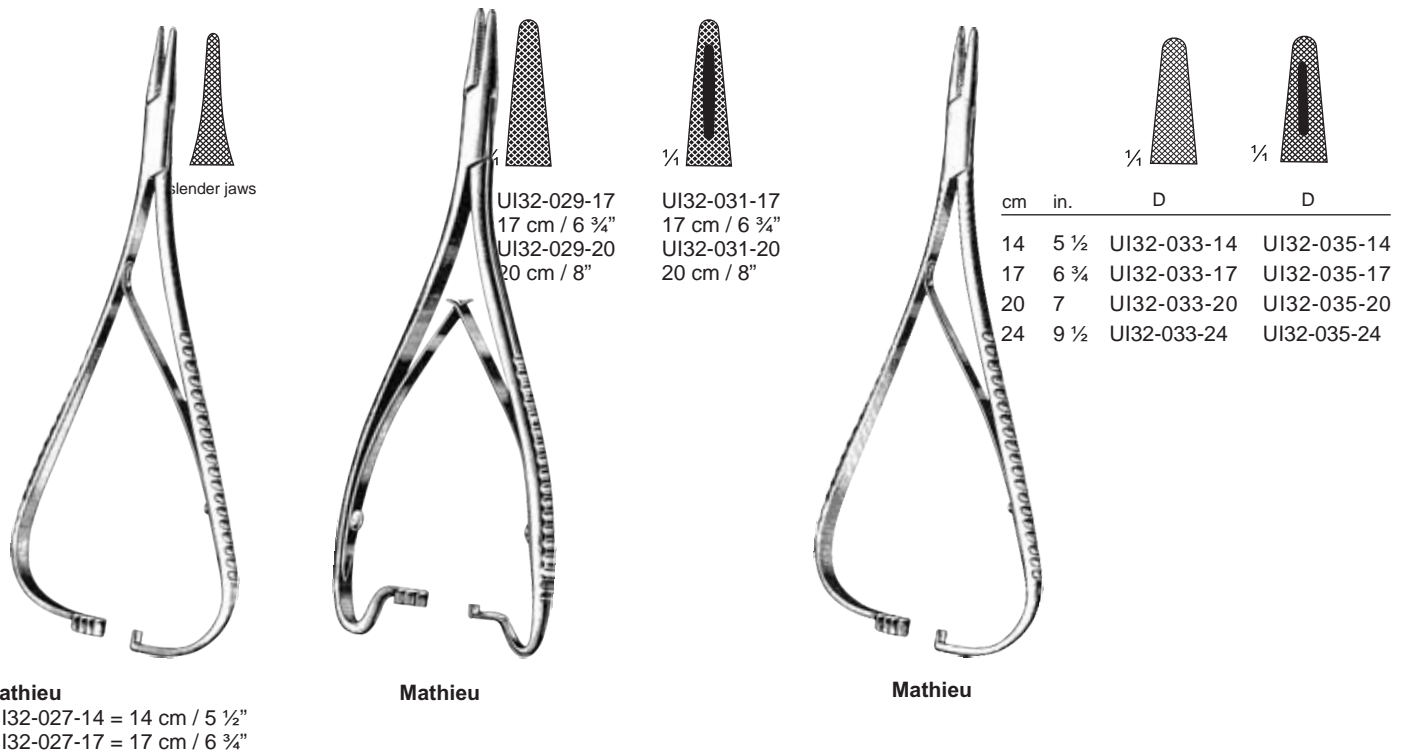
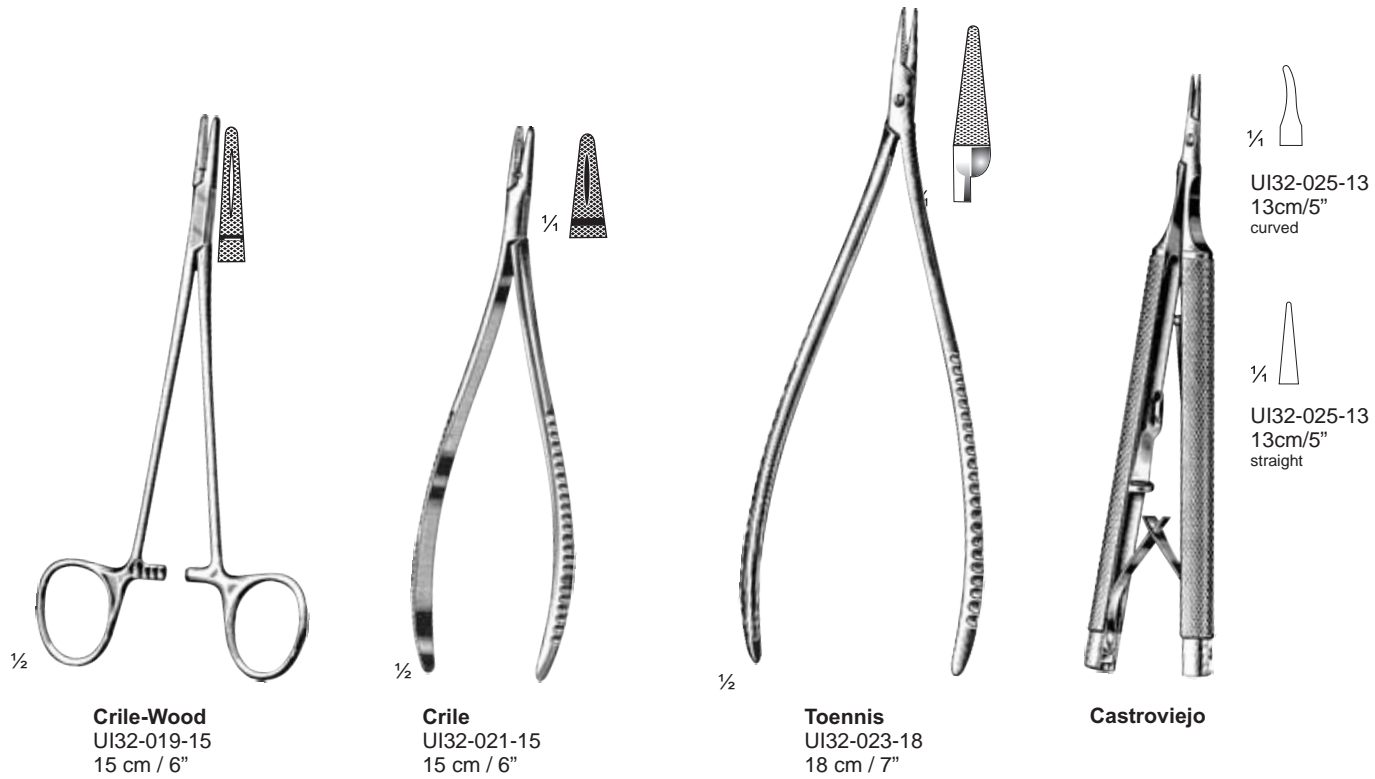
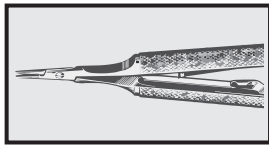

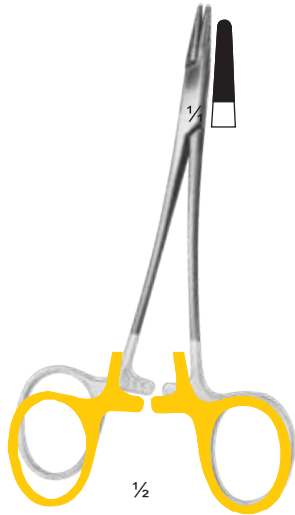
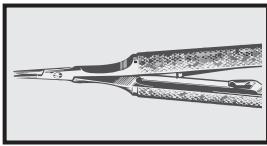

Webster
UI32-037-13
13cm/5"



Baumgartner
UI32-039-13
13cm/5"



Derf (Halsey)
UI32-041-12
12cm/4 3/4"



Derf (Halsey)



Crile-Wood

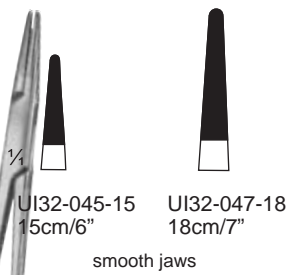

UI32-045-15 15cm/6"
UI32-047-18 18cm/7"
smooth jaws



New Orleans

UI32-049-18
18cm/7"

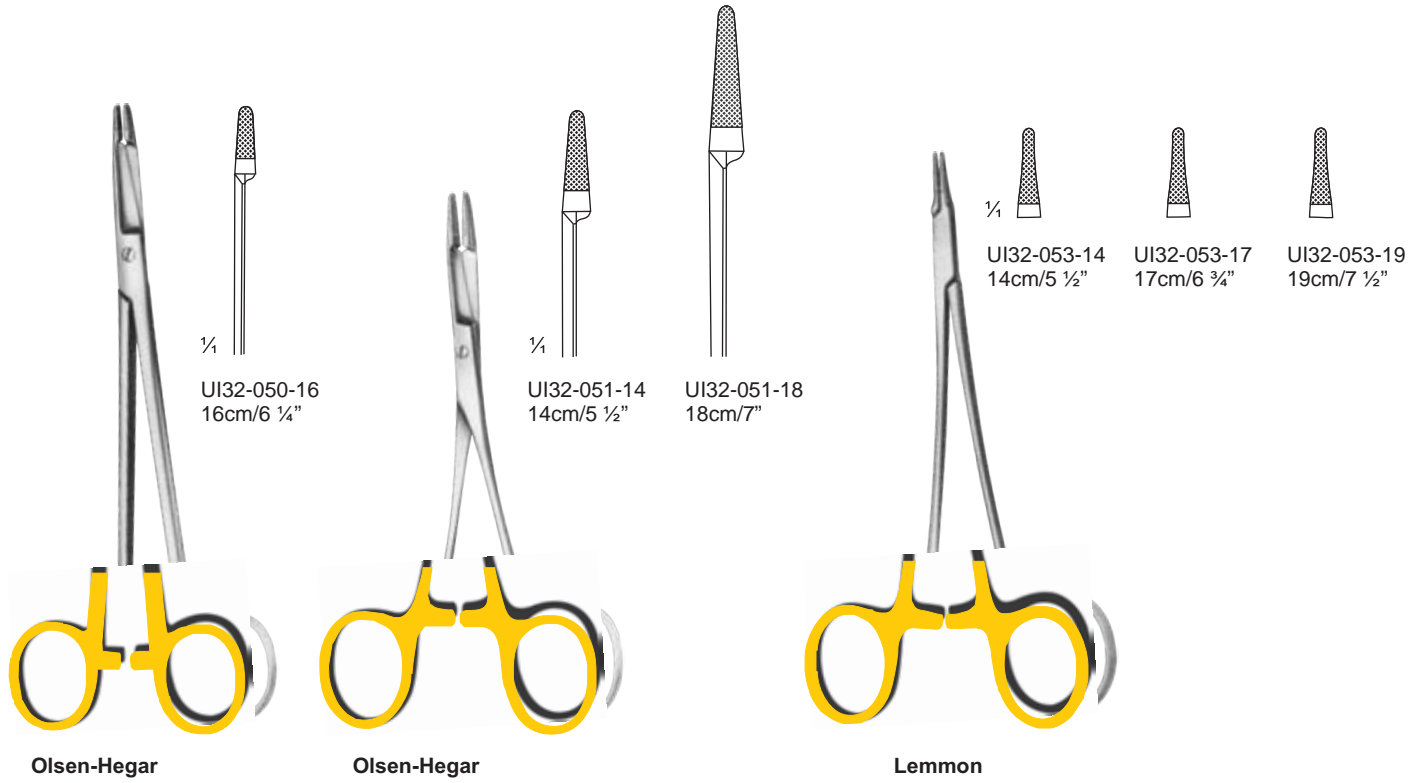
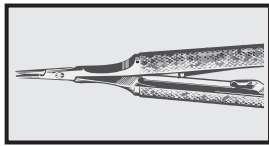

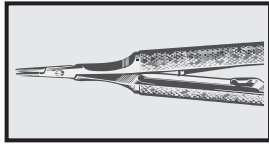



Crile-Wood

- 

UI32-061-13
13cm/5"
- 

UI32-061-15
15cm/6"
- 

UI32-061-18
18cm/7"
- 

UI32-061-20
20cm/8"
- 

UI32-061-23
23cm/9"





Mayo-Hegar

- 

UI32-063-14
14cm/5 1/2"
- 

UI32-063-16
16cm/6 1/4"
- 

UI32-063-18
18cm/7"
- 

UI32-063-20
20cm/8"
- 

UI32-063-23
23cm/9"
- 

UI32-063-26
26cm/10 1/4"
- 

UI32-063-30
30cm/12"

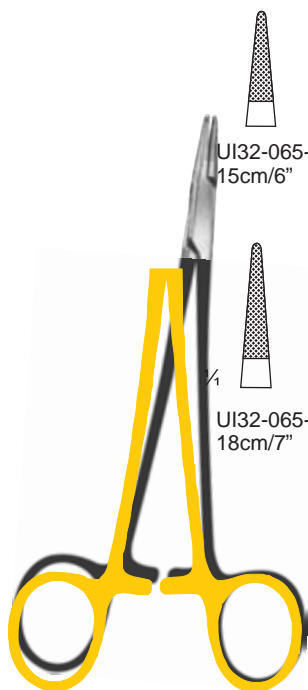

Crile Wood

- 

UI32-065-15
15cm/6"
- 

UI32-065-18
18cm/7"





Crile-Wood (Newman)

- 

UI32-067-15
15cm/6"
- 

UI32-067-18
18cm/7"
- 

UI32-067-20
20cm/8"
- 

UI32-067-23
23cm/9"
- 

UI32-067-26
26cm/10 1/4"

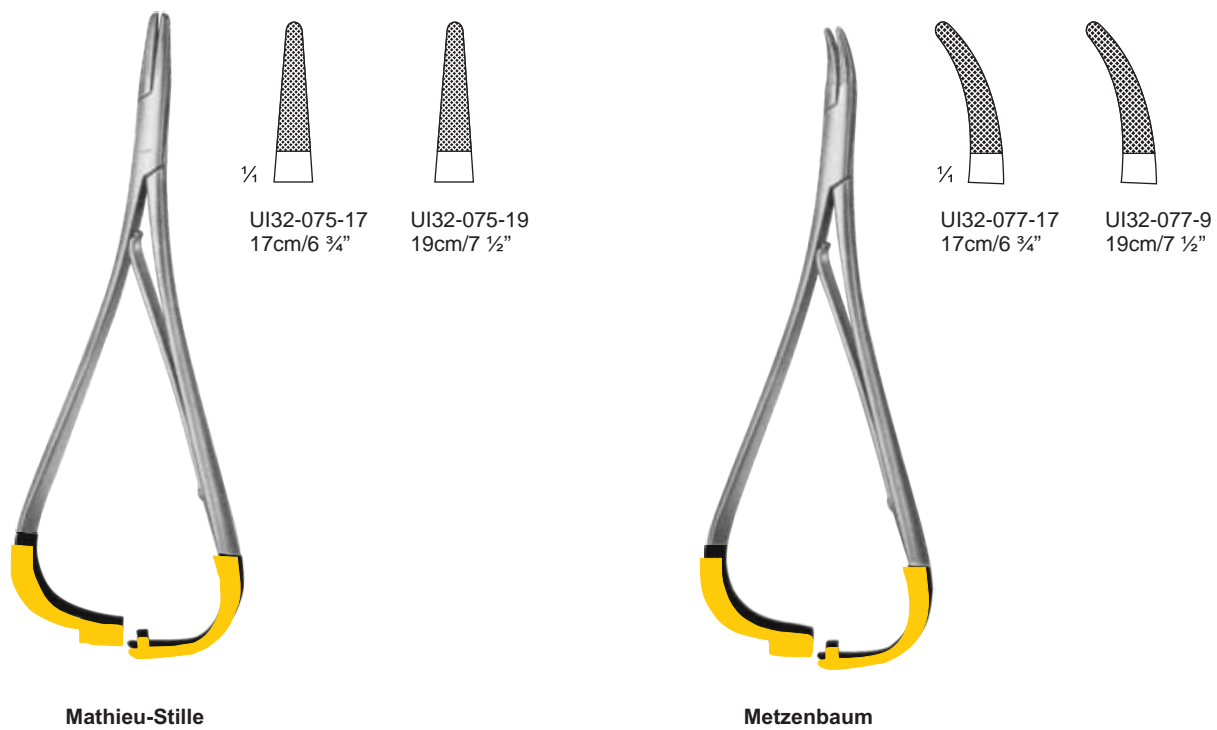
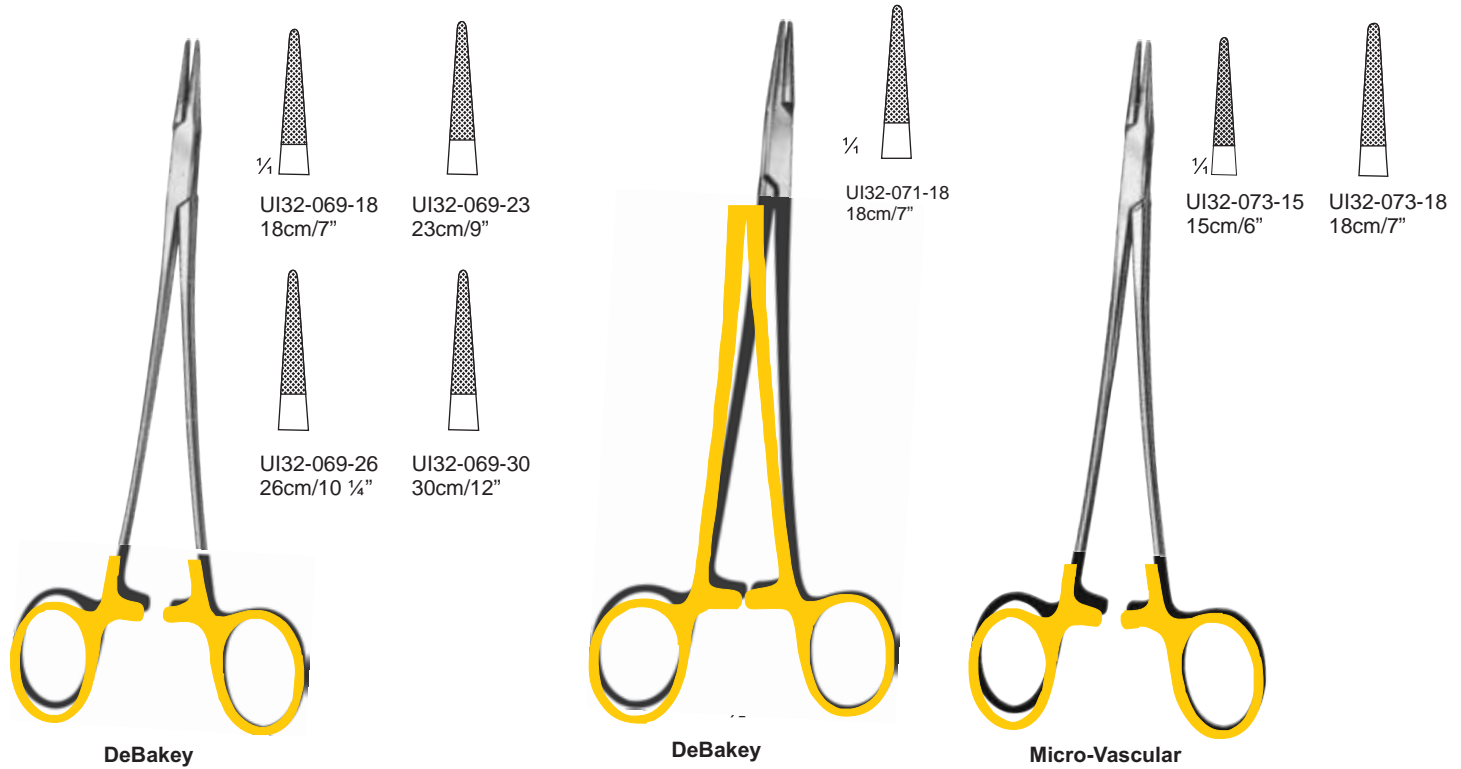
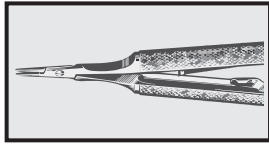

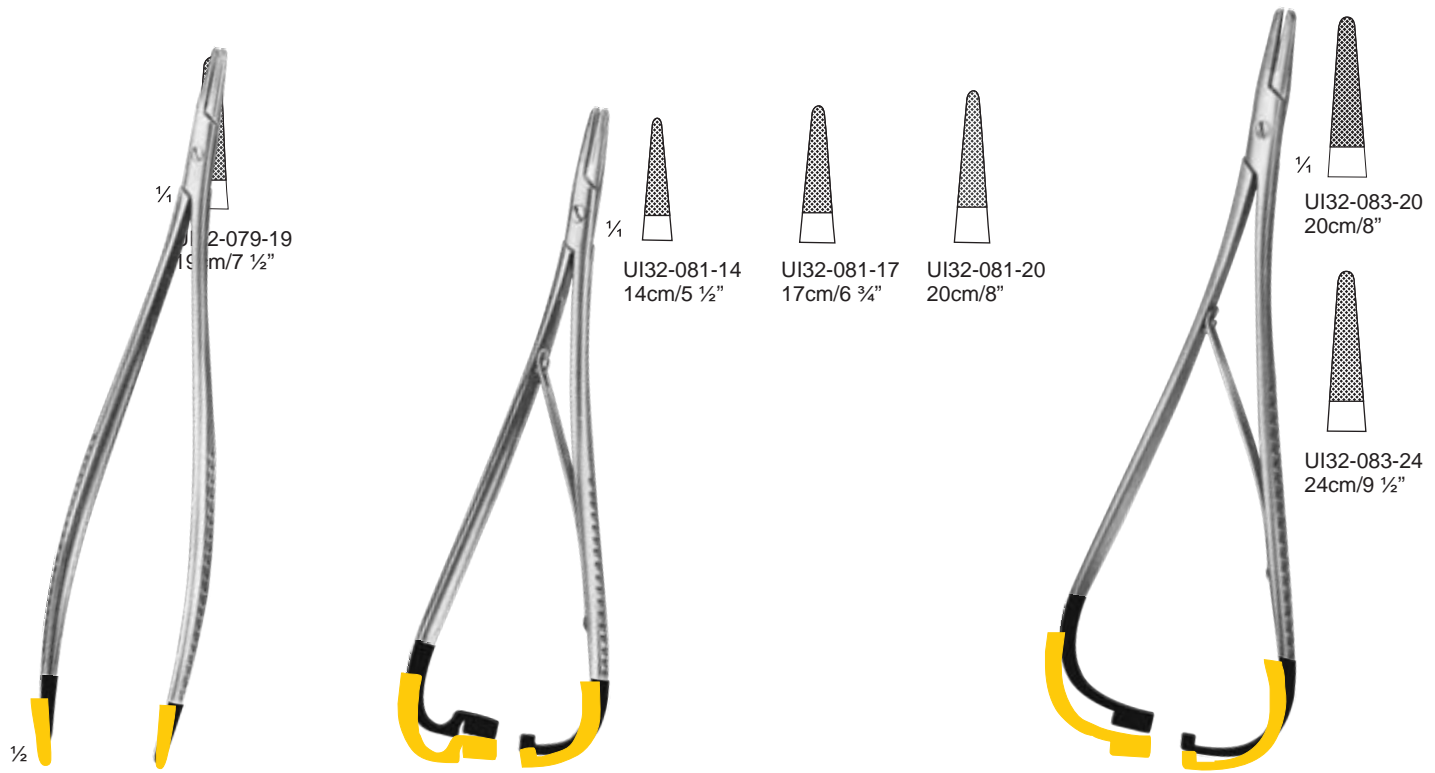
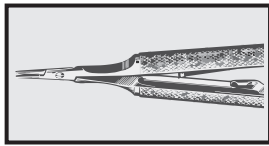

Tönnies

Lichtenberg

Mathieu

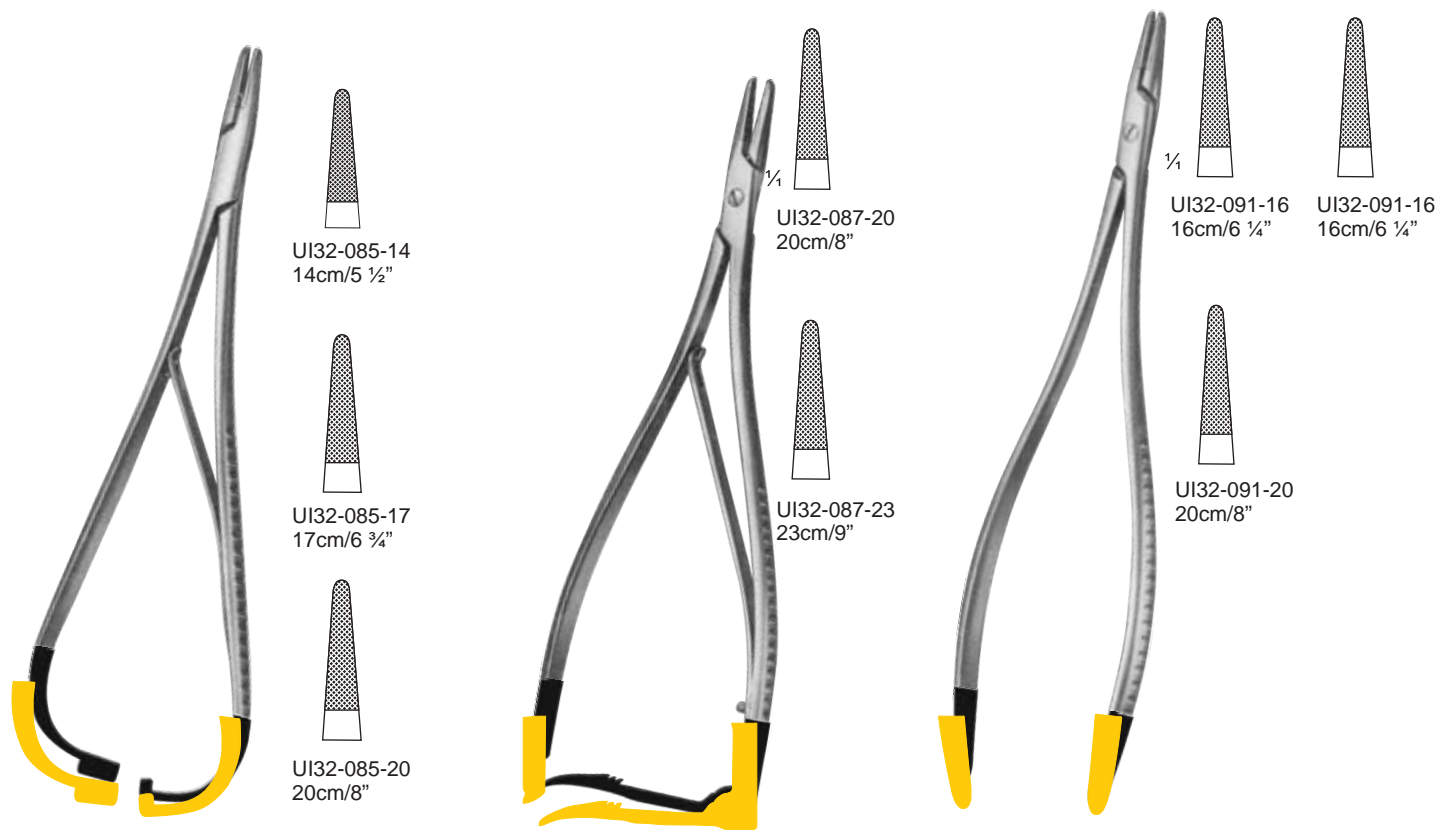

Mathieu

Zweifel

Langenbeck

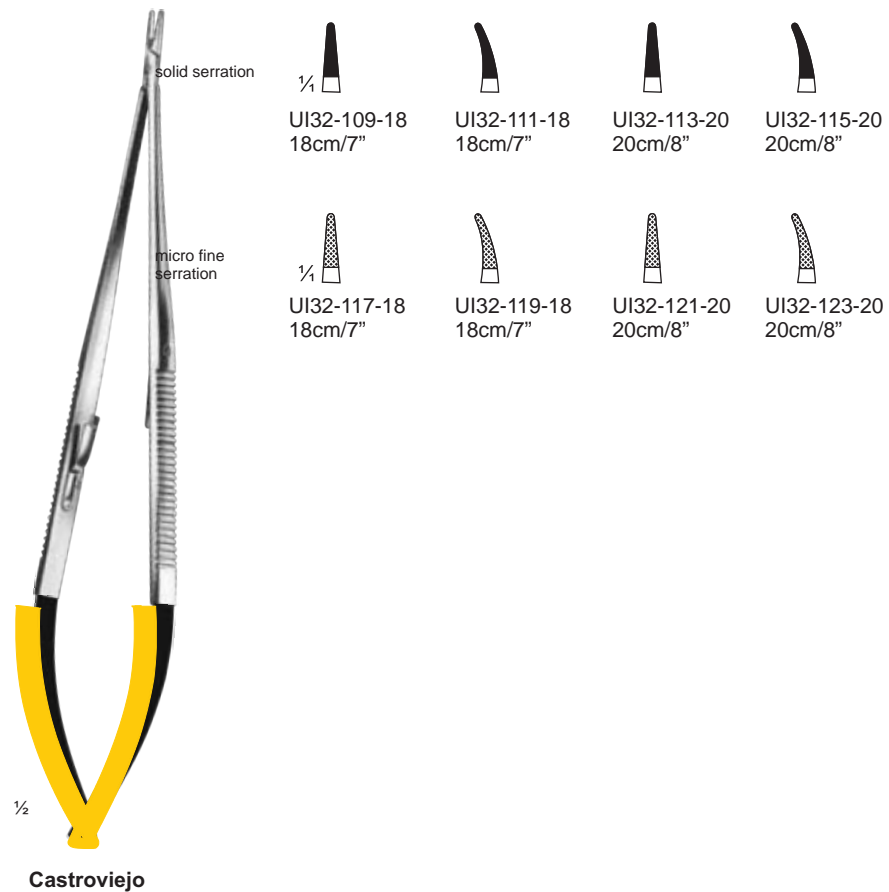
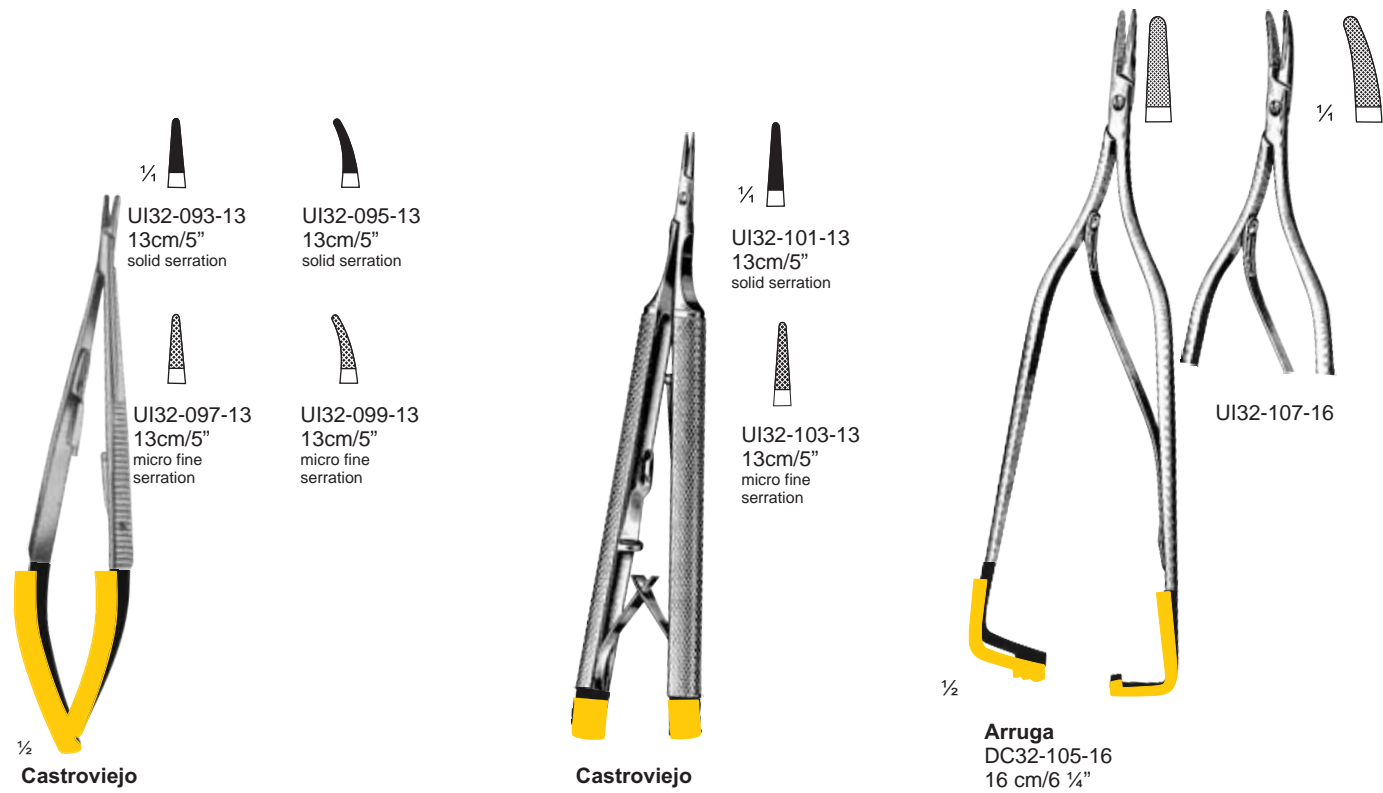
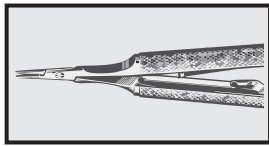



Lichtwitz
1.75 mm ø
UI32-125-17



Lichtwitz
2 mm ø
UI32-127-22



Pierce
UI32-129-3 mmø
UI32-129-4 mmø
UI32-129-5 mmø

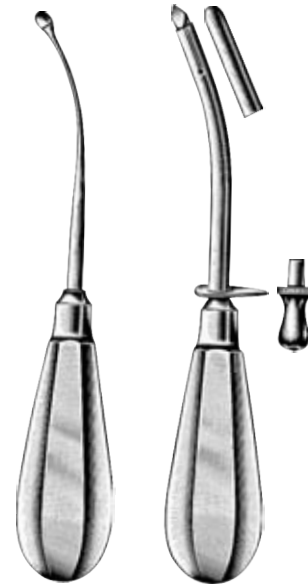

Krause
5.5 mm ø
UI32-131-55

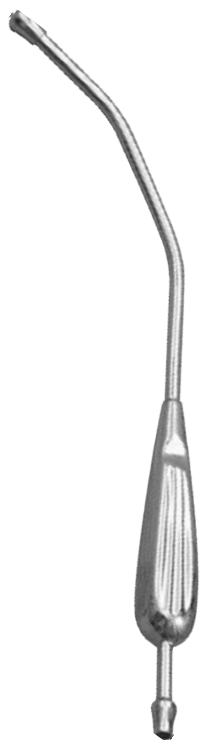

Yankauer
UI32-132-T



0
UI32-133-10



1
UI32-133-11



2
UI32-133-12



3
UI32-133-13

UI32-133-15

UI32-133-02



Yankauer
UI32-133-01



Schimmelbusch
UI32-135-01

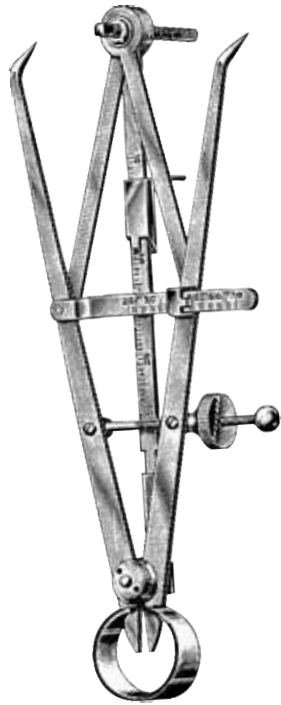
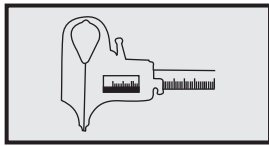

Korkhaus
UI32-137-01



18.5 cm / 7¼"
UI32-139-18



12 cm / 4¾"
UI32-141-12



UI32-143-01

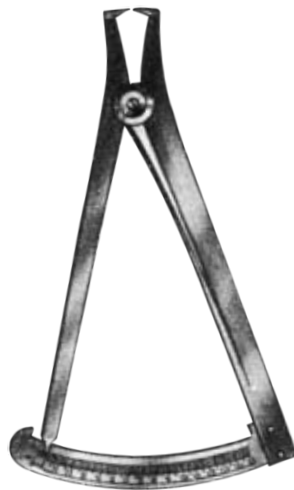

Measuring range 0-15 mm
UI32-145-15



Measuring range 0-10 mm
UI32-147-10

UI32-137-01	Three dimensional Caliper
UI32-139-18	Bow space for orthodontic work
UI32-141-12	Dividing Compass
UI32-143-01	Bow Compass
UI32-145-15	Decimal spring Caliper
UI32-147-10	Decimal spring Caliper

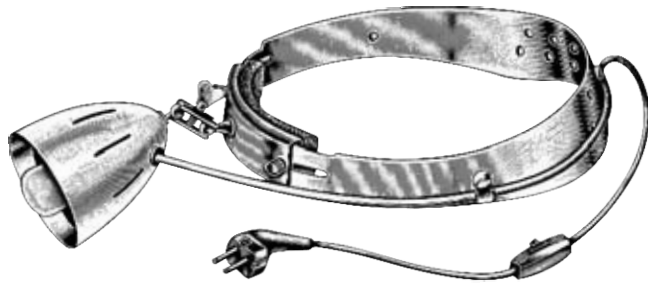
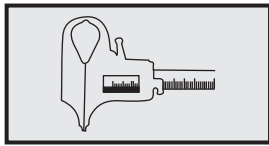

Orion
UI32-149-01

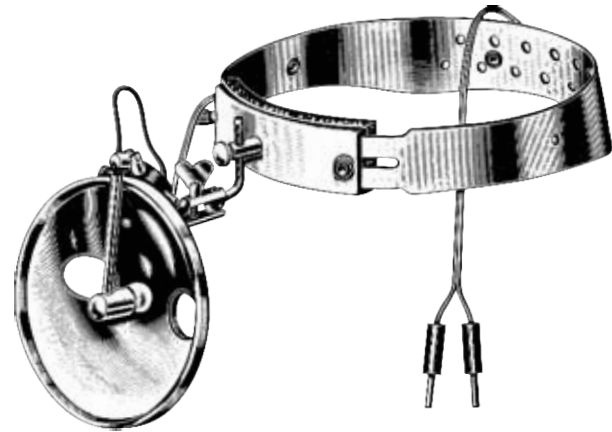

Clar
UI32-151-01

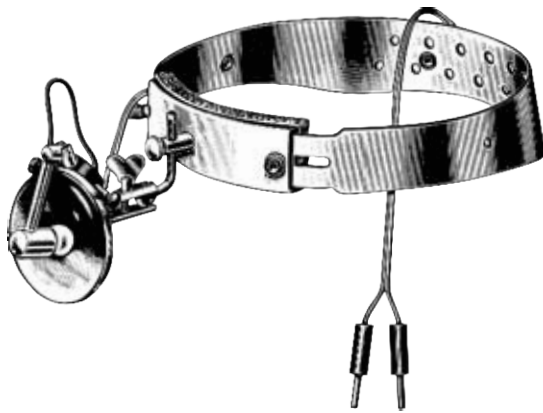

Clar-mini
UI32-153-01



11.5 cm / 4½"
UI32-155-11



11.5 cm / 4½"
UI32-157-11



Boley
UI32-159-01

UI32-149-01	UI32-151-01	Head Lamp
	UI32-153-01	Head Lamp
UI32-155-11	UI32-157-11	Tail Voice
	UI32-159-01	Caliper

 URIYA Instruments®



MOBILE : +61 402 764 684 / +923126505109 E-MAIL : info@uriyainstruments.com

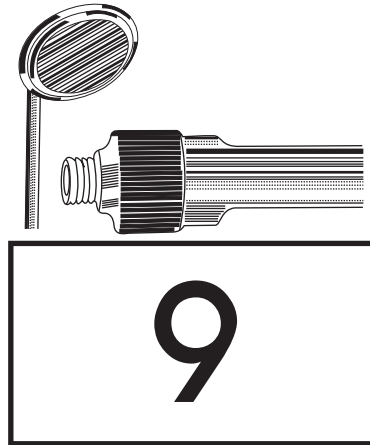

DENTAL MIRROR & SYRINGES

 URIYA Instruments®



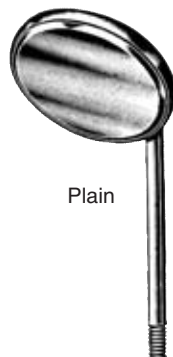
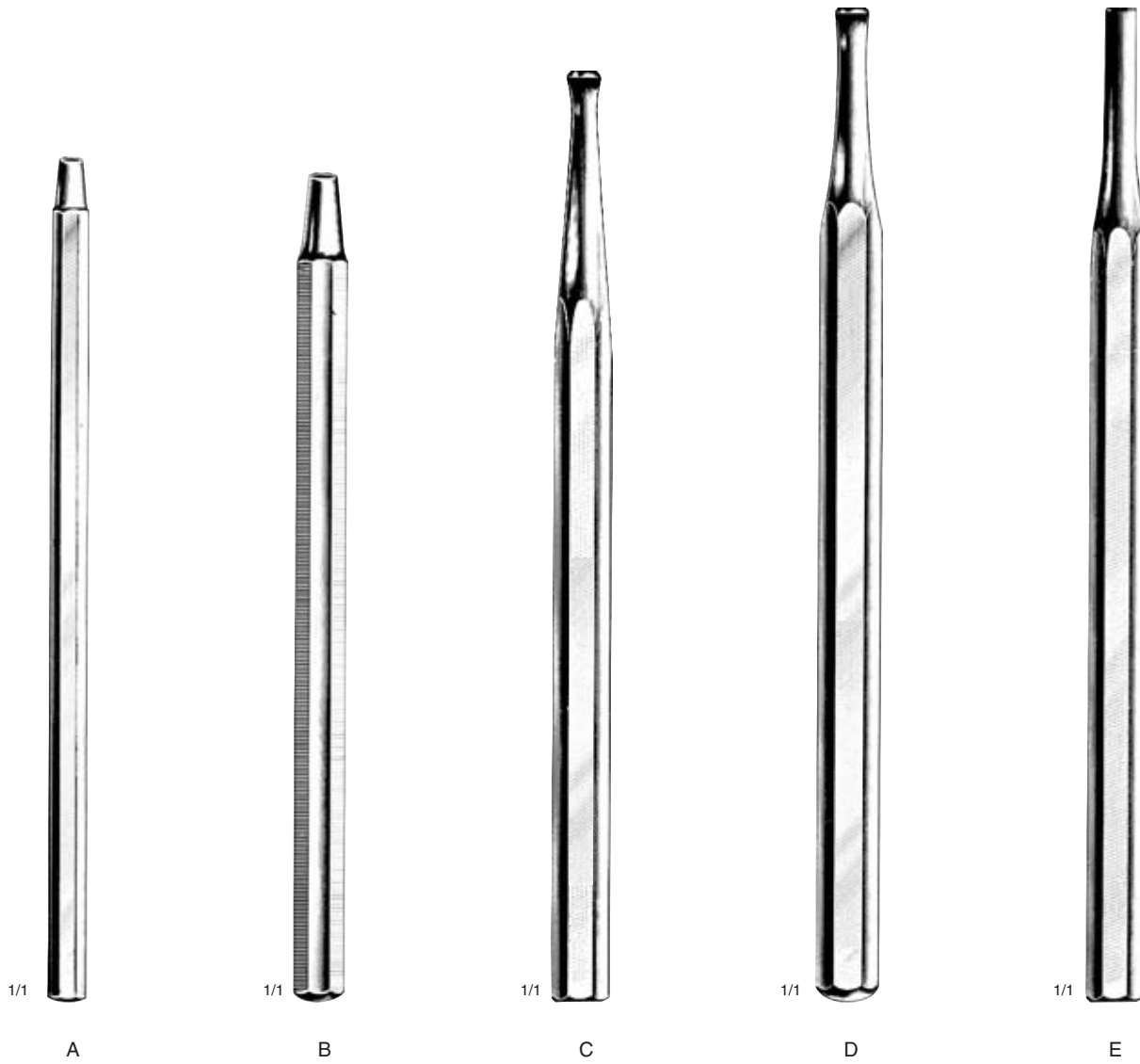
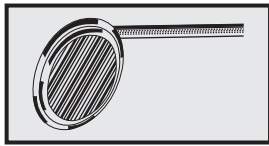

Plain

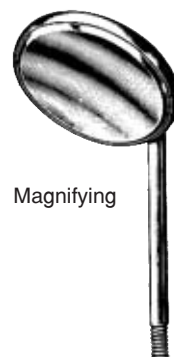

Magnifying

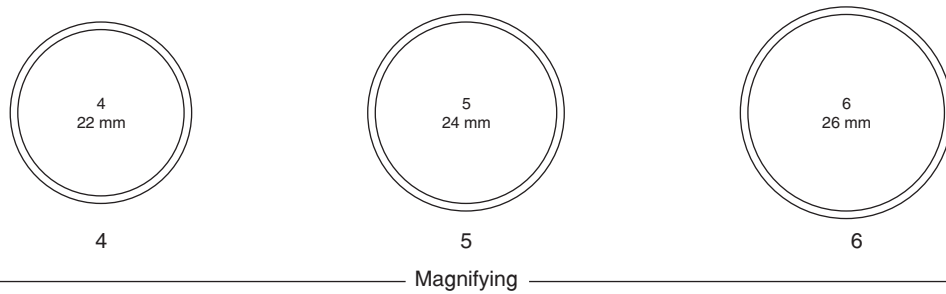
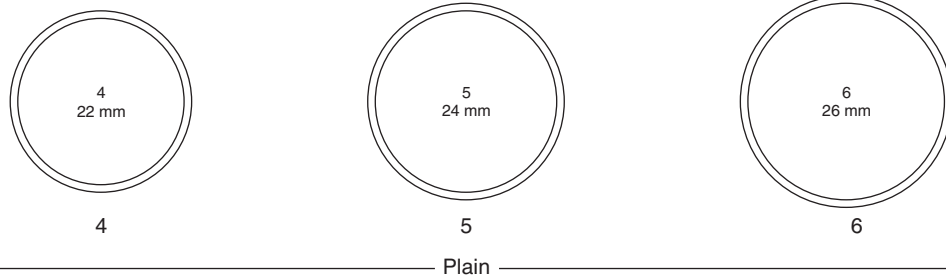
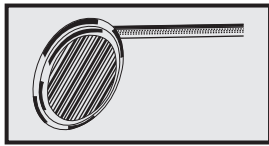

4 5 6

————— Plain —————

A	UI33-001-04	UI33-011-05	UI33-021-06
B	UI33-003-04	UI33-013-05	UI33-023-06
C	UI33-005-04	UI33-015-05	UI33-025-06
D	UI33-007-04	UI33-017-05	UI33-027-06
E	UI33-009-04	UI33-019-05	UI33-029-06

4 5 6

————— Magnifying —————

A	UI33-031-04	UI33-041-05	UI33-051-06
B	UI33-033-04	UI33-043-05	UI33-053-06
C	UI33-035-04	UI33-045-05	UI33-055-06
D	UI33-037-04	UI33-047-05	UI33-057-06
E	UI33-039-04	UI33-049-05	UI33-059-06

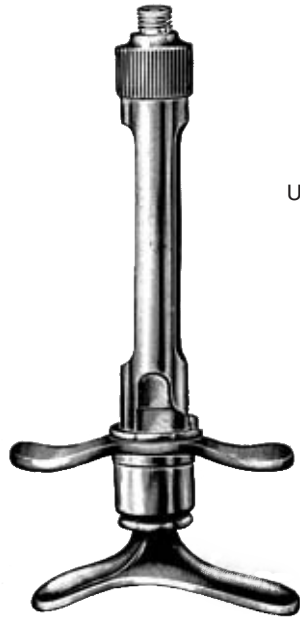
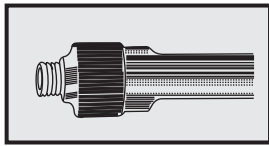

UI33-141-00
Cartridge Syringe



UI33-143-01



UI33-143-02



UI33-145-00

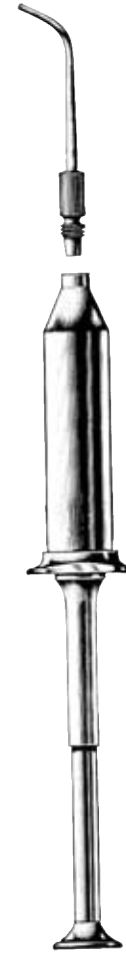

UI33-161-00



UI33-163-00



UI33-155-03
Cannulas



UI33-157-03
Cannulas



UI33-159-03
Cannulas

UI33-141-00	Cartridge Syringe
UI33-145-00	Chip Blower Syringe with cannula and bulb
UI33-155-03	UI33-159-03
UI33-161-00	UI33-163-00
	Metal Syringe

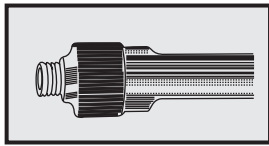

UI33-165-00



UI33-167-00



UI33-169-00



UI33-171-00



UI33-173-00



UI33-175-00

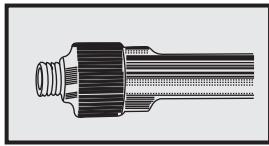

UI33-177-00

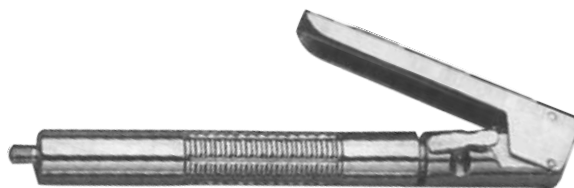

UI33-179-00

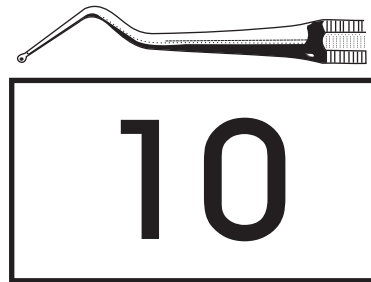

EXPLORERS

 URIYA Instruments®



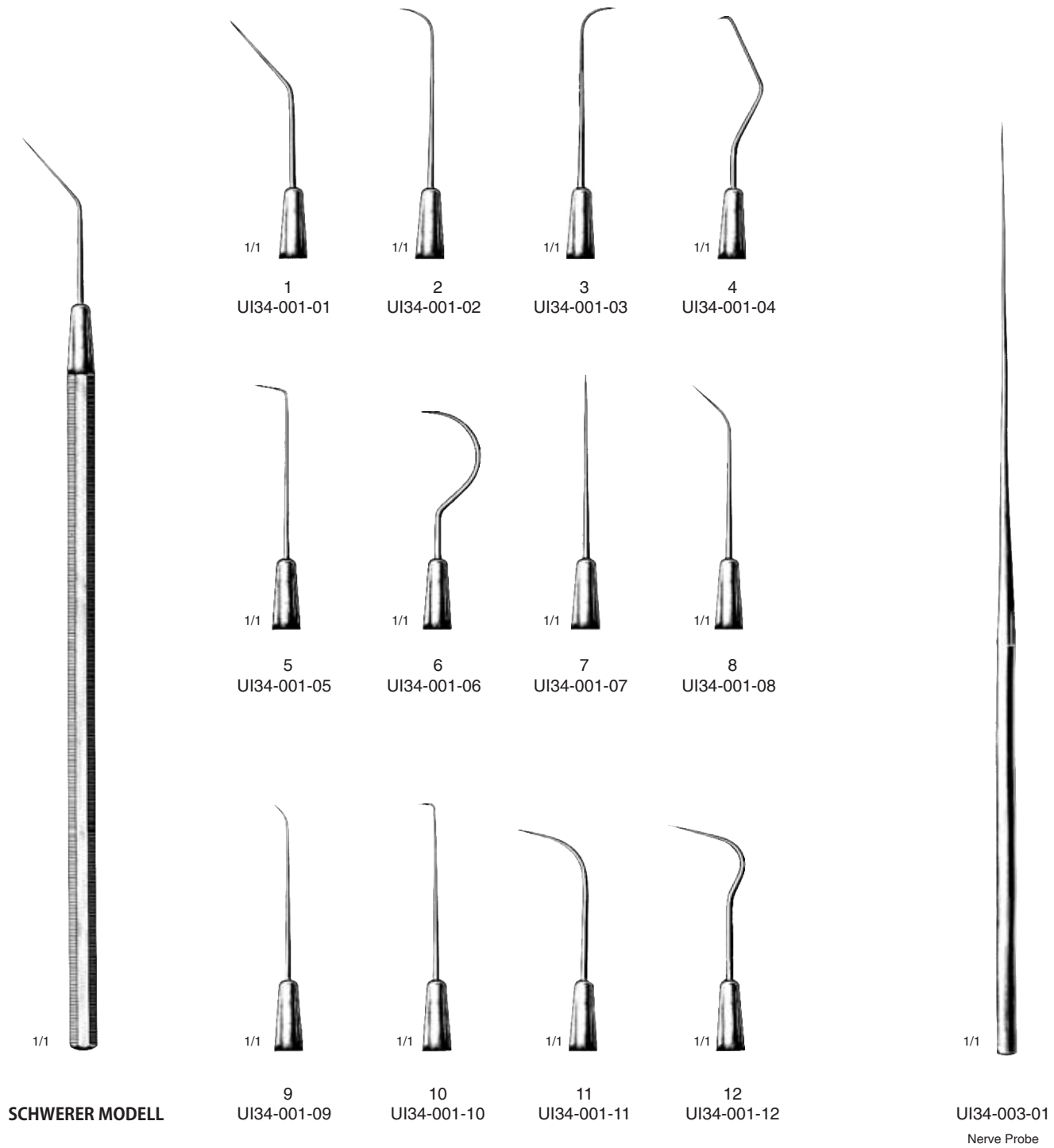
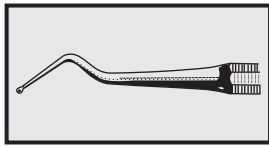

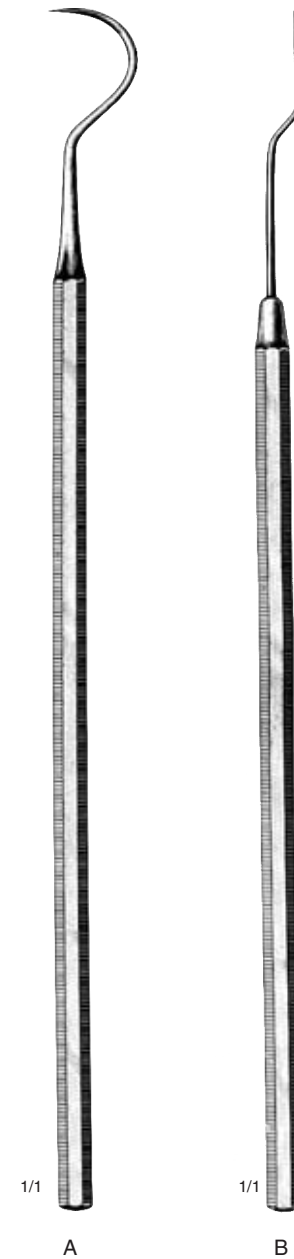
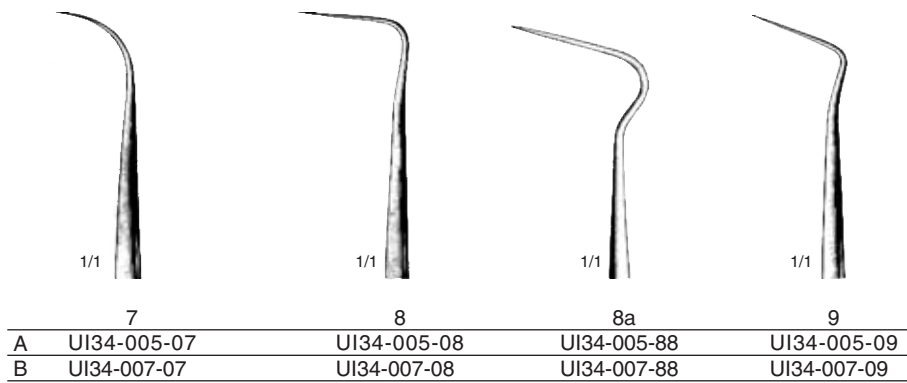
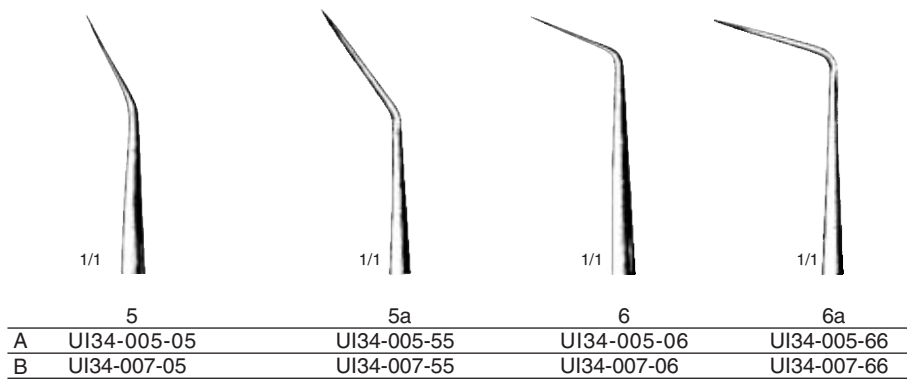
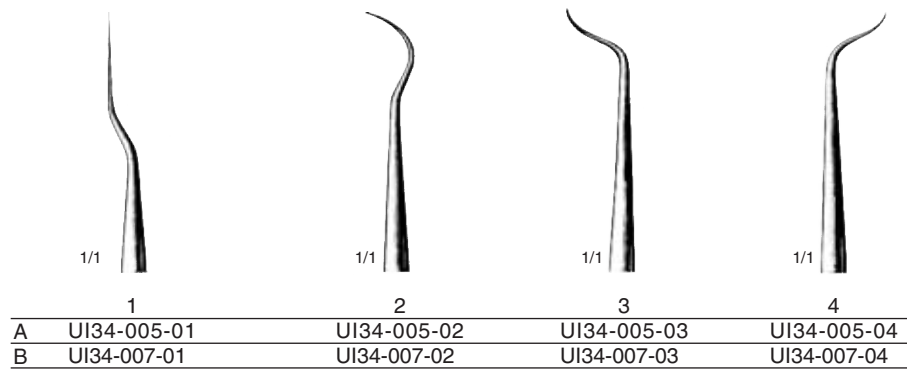
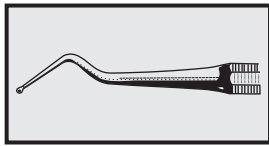

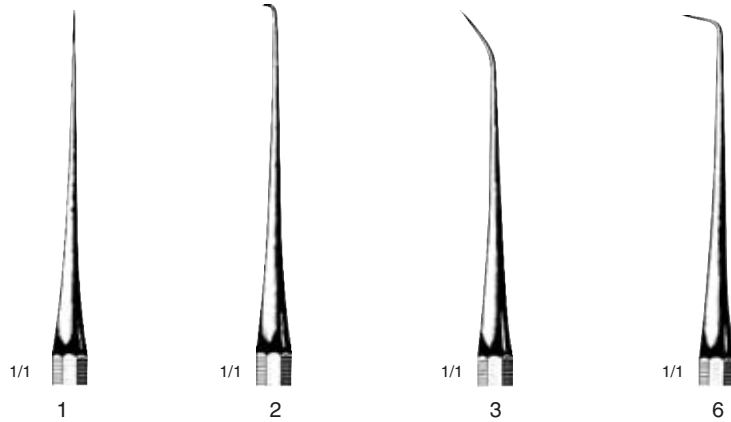
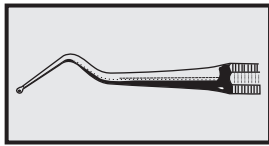

White

A	UI34-009-01	UI34-009-02	UI34-009-03	UI34-009-06
B	UI34-011-01	UI34-011-02	UI34-011-03	UI34-011-06
C	UI34-013-01	UI34-013-02	UI34-013-03	UI34-013-06

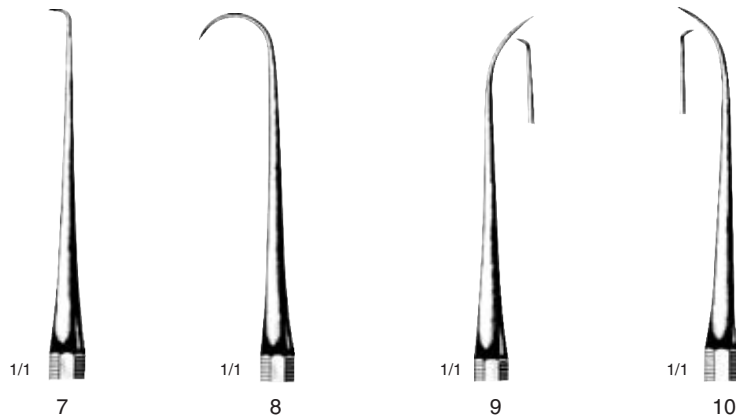

White

A	UI34-009-07	UI34-009-08	UI34-009-09	UI34-009-10
B	UI34-011-07	UI34-011-08	UI34-011-09	UI34-011-10
C	UI34-013-07	UI34-013-08	UI34-013-09	UI34-013-10

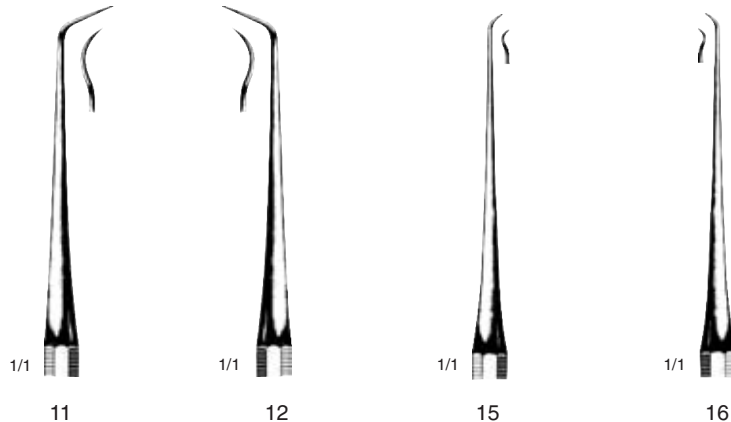

White

A	UI34-009-11	UI34-009-12	UI34-009-15	UI34-009-16
B	UI34-011-11	UI34-011-12	UI34-011-15	UI34-011-16
C	UI34-013-11	UI34-013-12	UI34-013-15	UI34-013-16

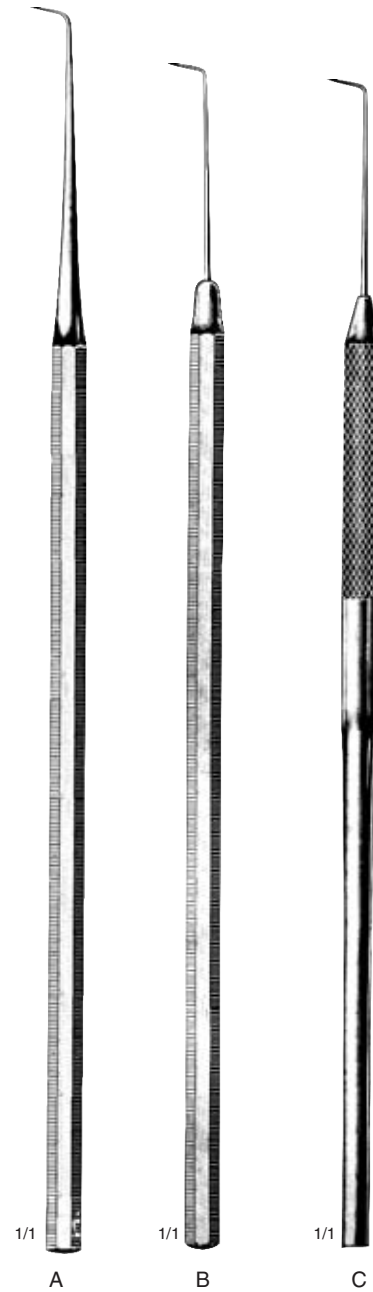

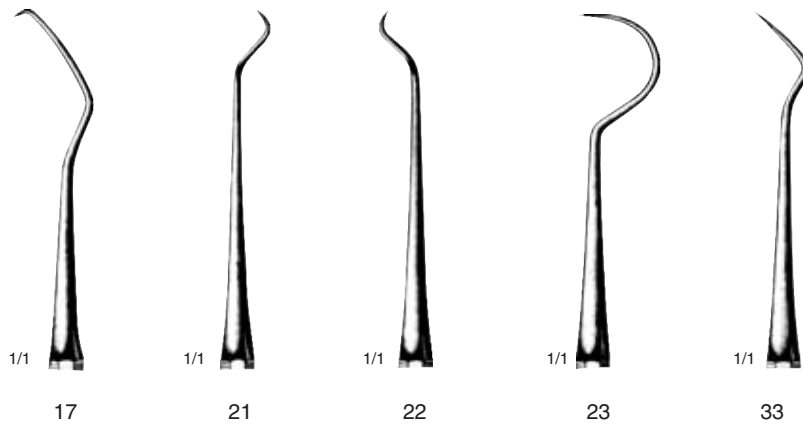
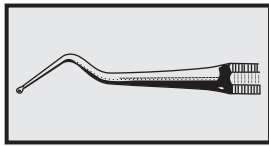

	White				
A	UI34-015-17	UI34-015-21	UI34-015-22	UI34-015-23	UI34-015-33
B	UI34-016-17	UI34-016-21	UI34-016-22	UI34-016-23	UI34-016-33
C	UI34-017-17	UI34-017-21	UI34-017-22	UI34-017-23	UI34-017-33

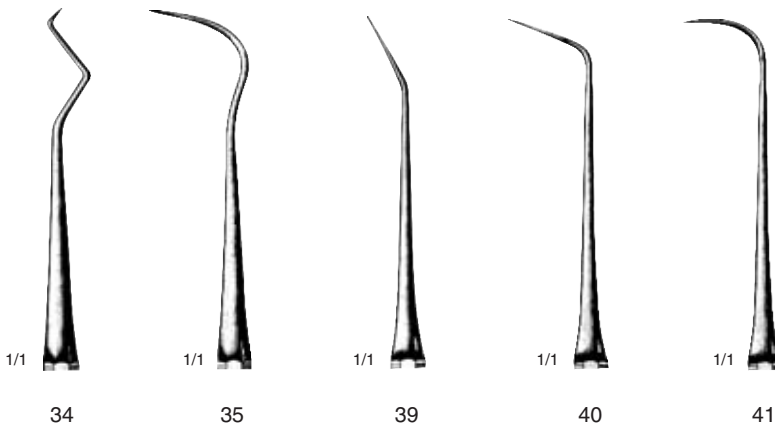

	White				
A	UI34-015- 34	UI34-015- 35	UI34-015- 39	UI34-015- 40	UI34-015- 41
B	UI34-016-34	UI34-016-35	UI34-016-39	UI34-016-40	UI34-016-41
C	UI34-017-34	UI34-017-35	UI34-017-39	UI34-017-40	UI34-017-41

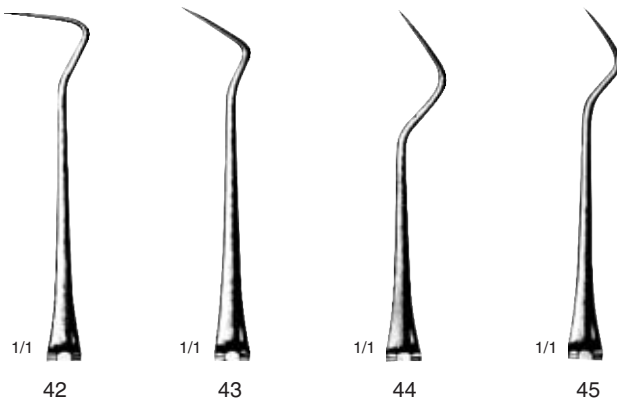

	White			
A	UI34-015- 42	UI34-015- 43	UI34-015- 44	UI34-015- 45
B	UI34-016-42	UI34-016-43	UI34-016-44	UI34-016-45
C	UI34-017-42	UI34-017-43	UI34-017-44	UI34-017-45

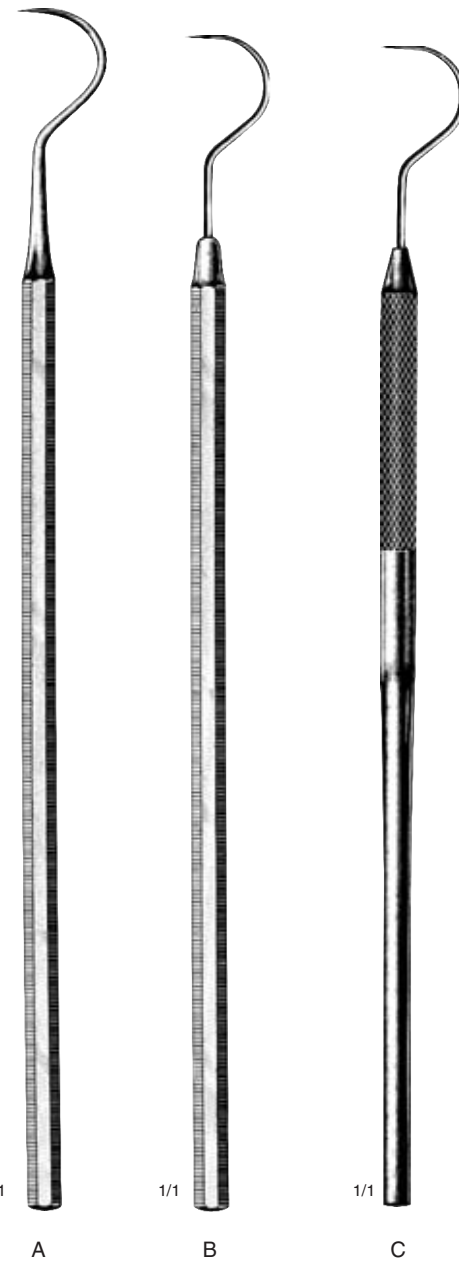

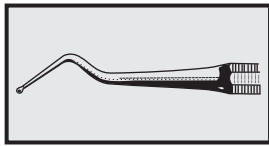

A	UI34-018-02	UI34-018-03	UI34-018-05	UI34-018-06
B	UI34-019-02	UI34-019-03	UI34-019-05	UI34-019-06
C	UI34-020-02	UI34-020-03	UI34-020-05	UI34-020-06

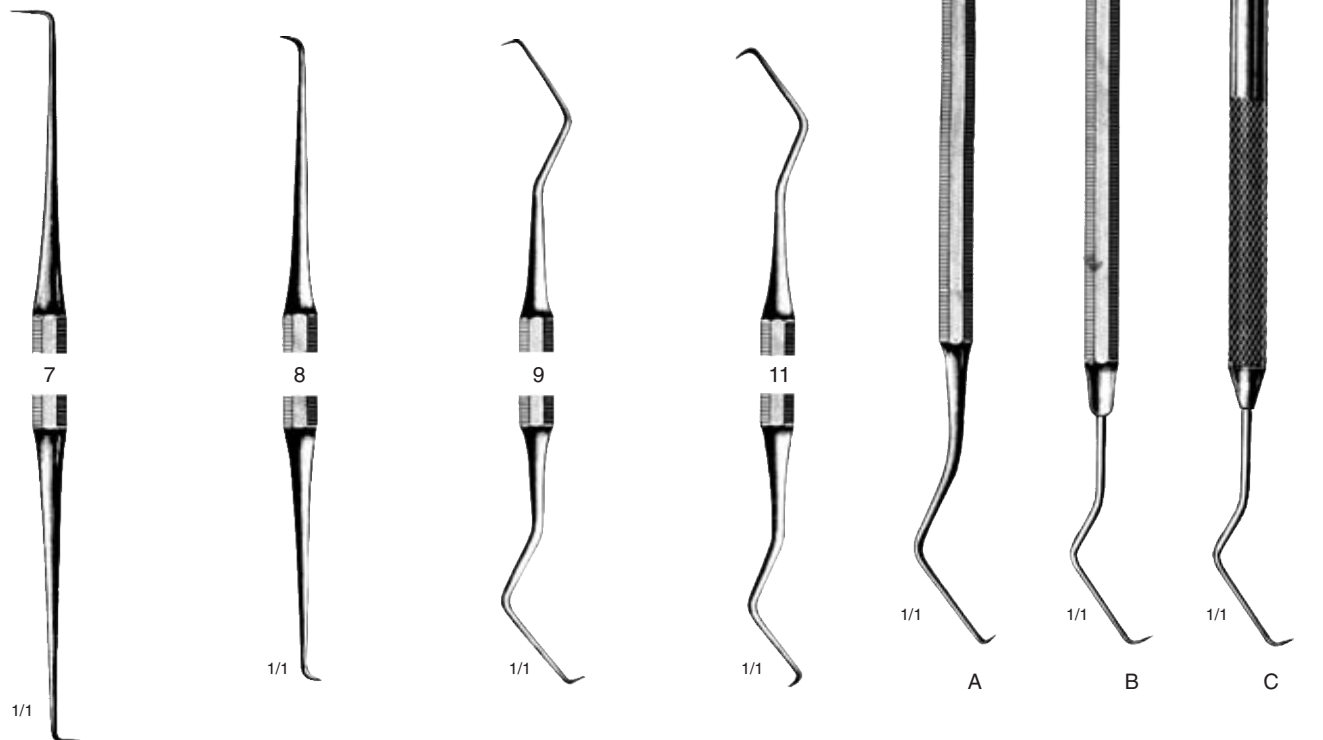

A	UI34-018-07	UI34-018-08	UI34-018-09	UI34-018-11
B	UI34-019-07	UI34-019-08	UI34-019-09	UI34-019-11
C	UI34-020-07	UI34-020-08	UI34-020-09	UI34-020-11

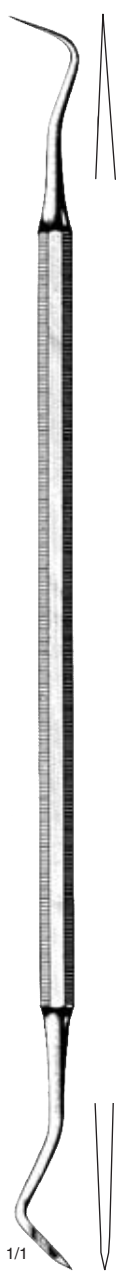
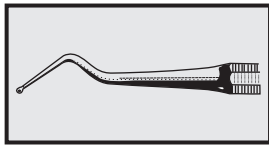

1/1
Lange
UI34-021-01

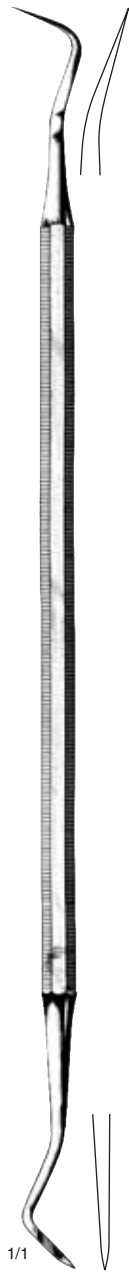

1/1
Lange
UI34-021-02



1/1
Weston
UI34-023-01



1/1
Weston
UI34-025-01

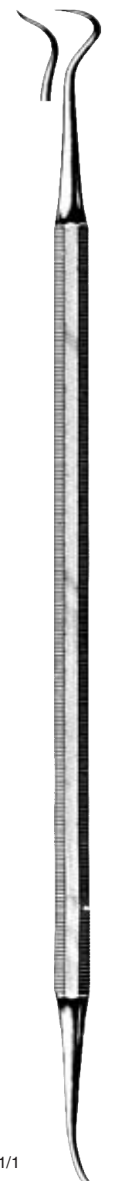

1/1
UI34-027-01



1/1
UI34-027-02



1/1
UI34-027-03

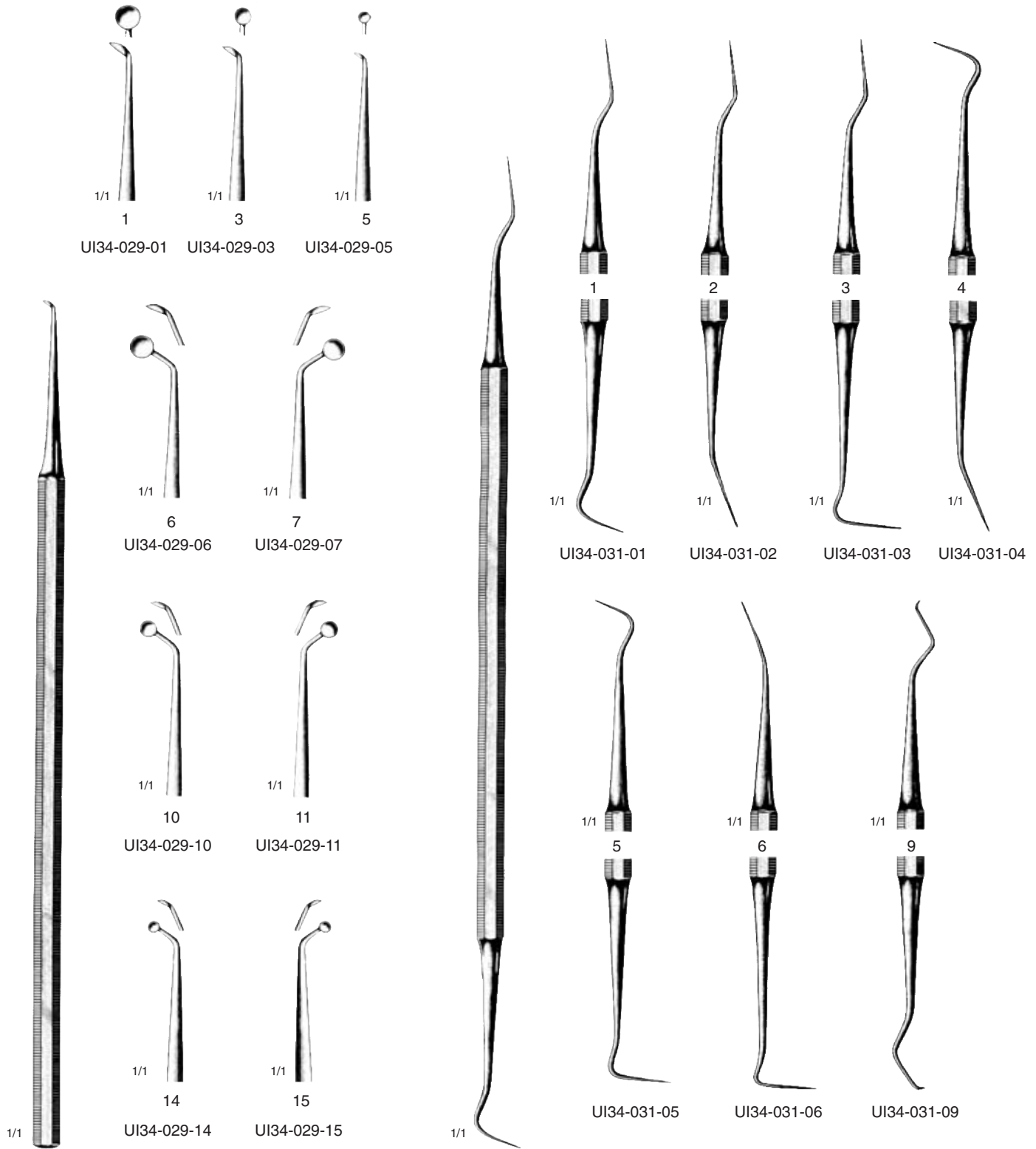
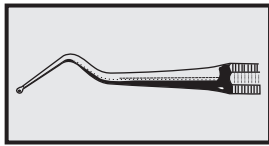

Witzel Dentine Spoon

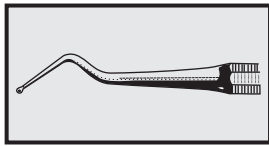

	 1/1 5	 1/1 6	 1/1 7	 1/1 8	 1/1 9	 1/1 10
A	UI34-033-05	UI34-033-06	UI34-033-07	UI34-033-08	UI34-033-09	UI34-033-10
	5/6		7/8		9/10	
E	UI34-035-05		UI34-035-07		UI34-035-09	

	 1/1 11	 1/1 12	 1/1 13	 1/1 14	 1/1 15	 1/1 16
A	UI34-033-11	UI34-033-12	UI34-033-13	UI34-033-14	UI34-033-15	UI34-033-16
	11/12		13/14		15/16	
E	UI34-035-11		UI34-035-13		UI34-035-15	

 1/1 A	 1/1 E	 1/1 17	 1/1 18	 1/1 19	 1/1 20	 1/1 21	 1/1 22
A	UI34-033-17	UI34-033-18	UI34-033-19	UI34-033-20	UI34-033-21	UI34-033-22	
	17/18		19/20		21/22		
E	UI34-035-17		UI34-035-19		UI34-035-21		

Darby-Perry

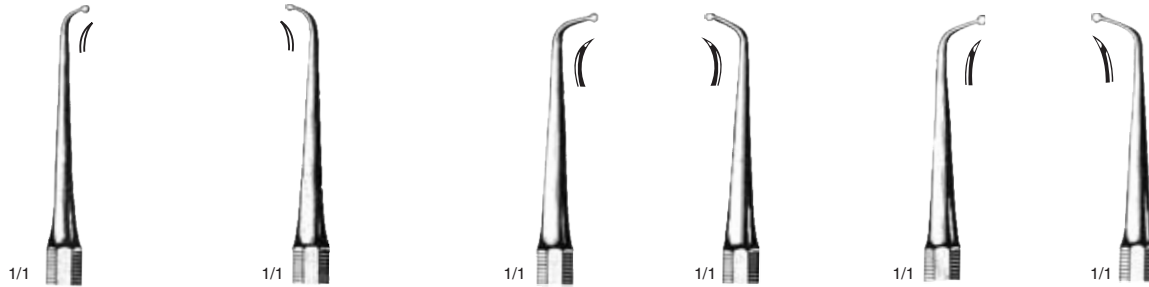
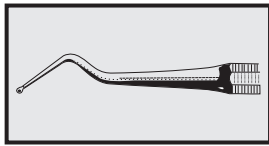

	3	4	7	8	9	10
A	UI34-037-03	UI34-037-04	UI34-037-07	UI34-037-08	UI34-037-09	UI34-037-10
	3/4		7/8		9/8	
E	UI34-039-03		UI34-039-07		UI34-039-09	

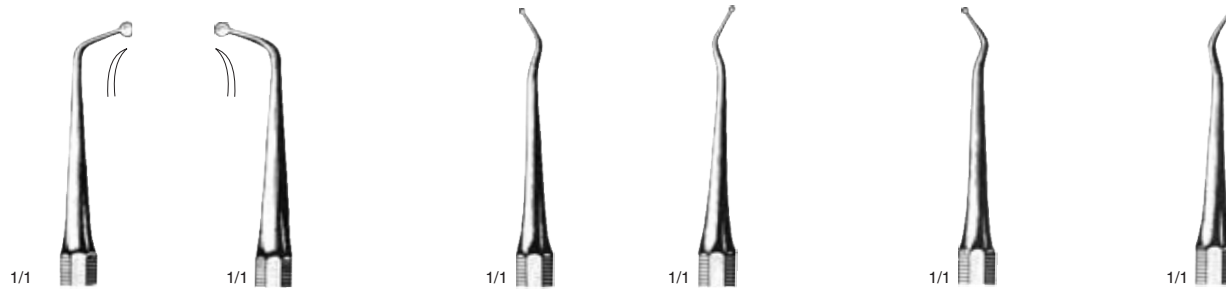



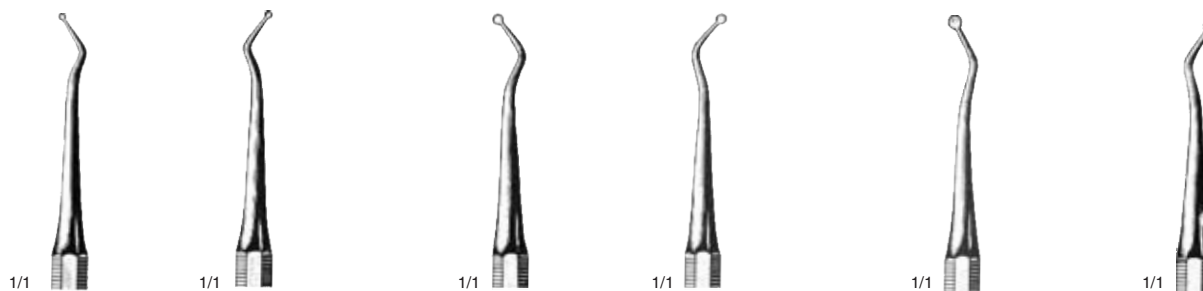



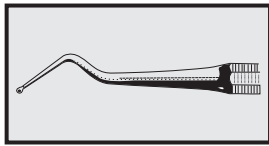







	11	12	13	14	15	16
A	UI34-037-11	UI34-037-12	UI34-037-13	UI34-037-14	UI34-037-15	UI34-037-16
	11/12		13/14		15/16	
E	UI34-039-11		UI34-039-13		UI34-039-15	











	17	18	19	20	21	22
A	UI34-037-17	UI34-037-18	UI34-037-19	UI34-037-20	UI34-037-21	UI34-037-22
	17/18		19/20		21/22	
E	UI34-039-17		UI34-039-19		UI34-039-21	



						
	1/1	1/1	1/1	1/1	1/1	1/1
	23	24	25	26	27	28
A	UI34-037-23	UI34-037-24	UI34-037-25	UI34-037-26	UI34-037-21	UI34-037-28
	23/24		25/26		27/28	
E	UI34-039-23		UI34-039-25		UI34-039-27	

								
	1/1	1/1	1/1	1/1	1/1	1/1	1/1	1/1
	29	30	31	32	33	34	35	36
A	UI34-037-29	UI34-037-30	UI34-037-31	UI34-037-32	UI34-037-33	UI34-037-34	UI34-037-35	UI34-037-36
	29/30		31/32		33/34		35/36	
E	UI34-039-29		UI34-039-31		UI34-039-33		UI34-039-35	

								
	1/1	1/1	1/1	1/1	1/1	1/1	1/1	1/1
	4	5	6	7	12	13	14	15
	Gillet	Gillet	Gillet	Gillet	Gillet	Gillet	Gillet	Gillet
A	UI34-041-04	UI34-041-05	UI34-041-06	UI34-041-07	UI34-041-12	UI34-041-13	UI34-041-14	UI34-041-15
	4/5		6/7		12/13		14/15	
E	UI34-043-04		UI34-043-06		UI34-043-12		UI34-043-14	

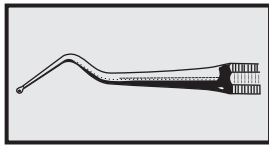

	171	172	173	174
A	UI34-045-71	UI34-045-72	UI34-045-73	UI34-045-74
	171/172		173/174	
E	UI34-047-71		UI34-047-73	

	175	176
A	UI34-045-75	UI34-045-76
	175/176	
E	UI34-047-75	

	177	178	179	180
A	UI34-045-77	UI34-045-78	UI34-045-79	UI34-045-80
	177/178		179/180	
E	UI34-047-77		UI34-047-79	

Friedman
UI34-049-01

Friedman
UI34-051-01

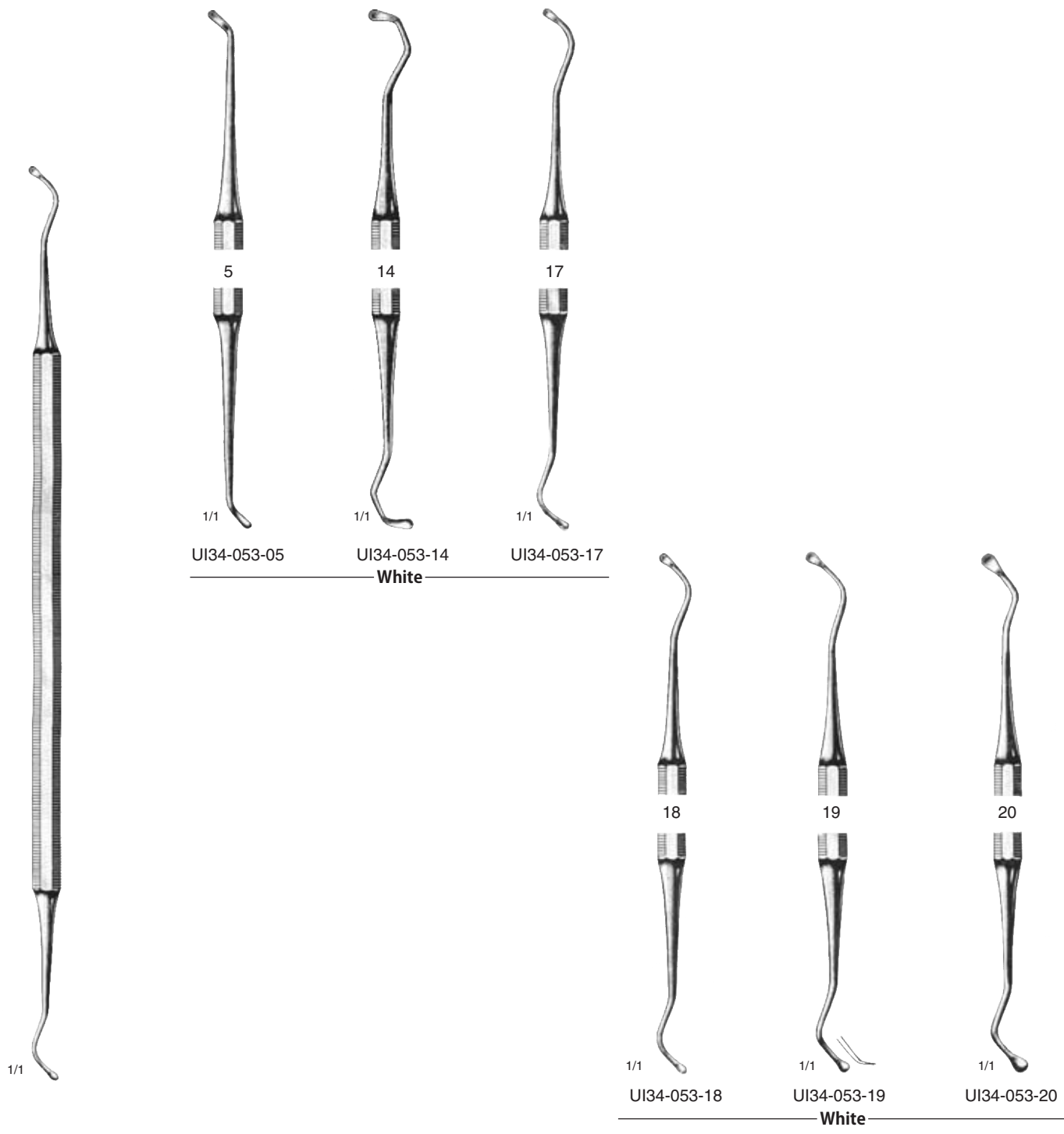
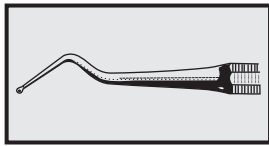

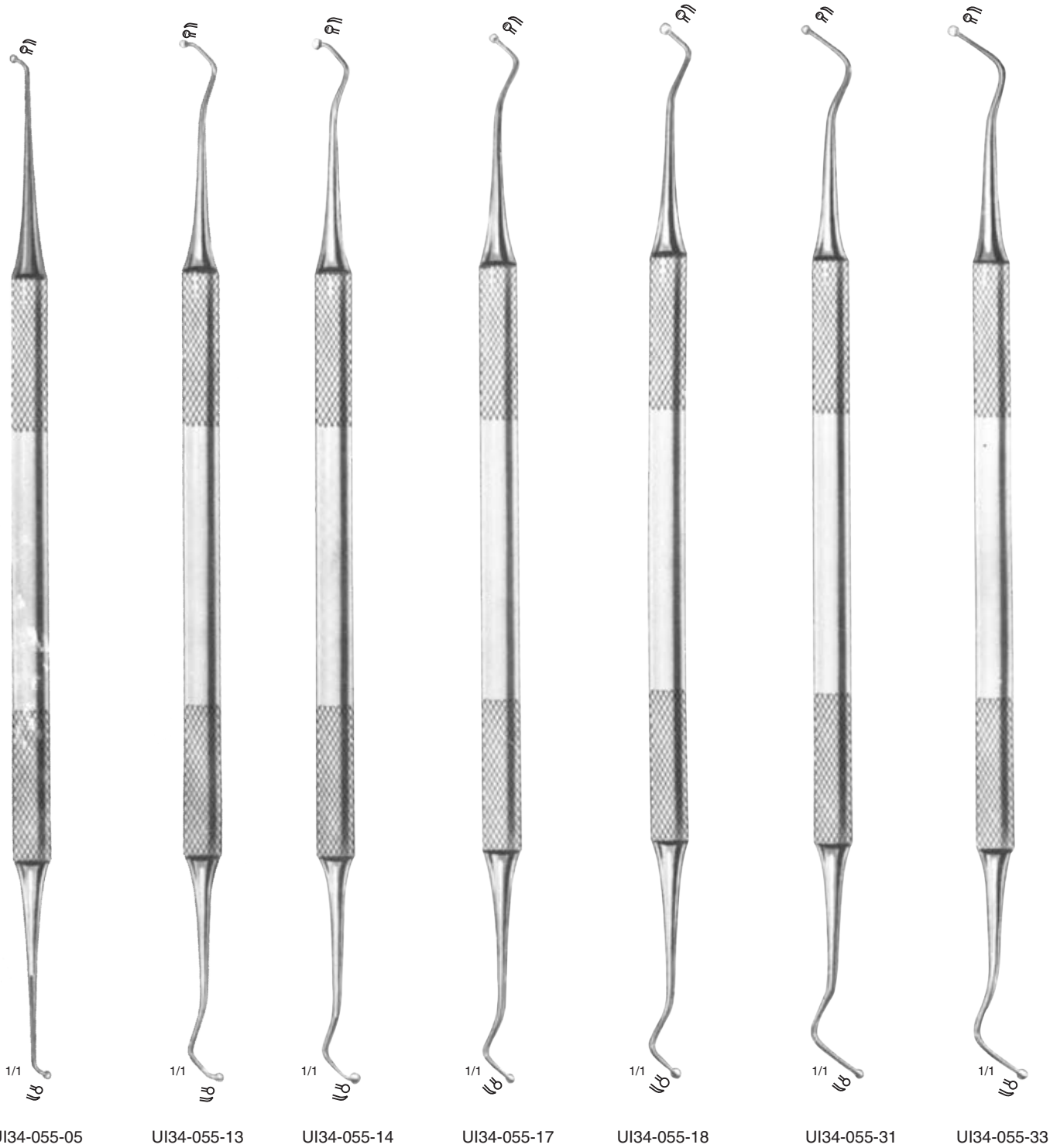
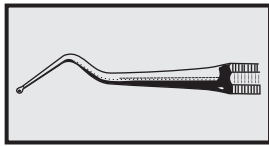

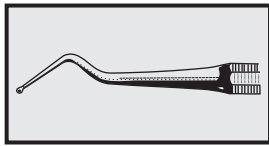

1/1 Black							
	3	9	14	17	20	28	32
	UI34-057-03	UI34-057-09	UI34-057-14	UI34-057-17	UI34-057-20	UI34-057-28	UI34-057-32
	A 10	10	12	6	12	8	12
	B 4	4	5	2	5	3	5
	C 6	12	18	18	23	6	12
	38	41	51	52	53	54	57
	UI34-057-38	UI34-057-41	UI34-057-51	UI34-057-52	UI34-057-53	UI34-057-54	UI34-057-57
	A 12	6	15	15	10	10	15
B 5	2	8	8	6	6	8	
C 18	18	12	12	12	12	6	
		L	R	L	R	L	
58	61	62	63	64	65	66	
UI34-057-58	UI34-057-61	UI34-057-62	UI34-057-63	UI34-057-64	UI34-057-65	UI34-057-66	
15	20	20	15	15	10	10	
A 8	9	9	8	8	6	6	
B 6	12	12	12	12	12	12	
C R	L	R	L	R	L	R	

A) Width of Blade in 1/10 mm
 B) Length of the blade in mm
 C) Angle of the blade to its handle

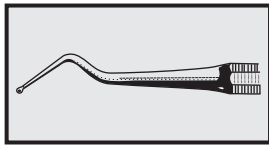

1/1 1/1							
	69	70	73	74	75	76	77
	UI34-059-69	UI34-059-70	UI34-059-73	UI34-059-74	UI34-059-75	UI34-059-76	UI34-059-77
	A 15	15	20	20	20	20	15
	B 8	8	9	9	9	9	8
	C 23	23	12	12	12	12	12
	L	R	L	R	L	R	L
	78	81	82	83	84	85	
	UI34-059-78	UI34-059-81	UI34-059-82	UI34-059-83	UI34-059-84	UI34-059-85	
A 15	20	15	10	20	15		
B 8	9	8	6				
C 12	6	6	6				
R							
86	87	90	93	95	98	99	
UI34-059-86	UI34-059-87	UI34-059-90	UI34-059-93	UI34-059-95	UI34-059-98	UI34-059-99	
A 10	5	15	15	12	8	12	
B 3	3	1½		8	6	8	
C 28	28	12		12	23	12	

A) Width of Blade in 1/10 mm
 B) Length of the blade in mm
 C) Angle of the blade to its handle

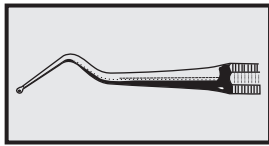

1/1

49	51	53	57	61	63
UI34-061-49	UI34-061-51	UI34-061-53	UI34-061-57	UI34-061-61	UI34-061-63
20	15	10	15	20	15
9	8	6	8	9	8
12	12	12	6	12	12
L	L	L	L	L	L

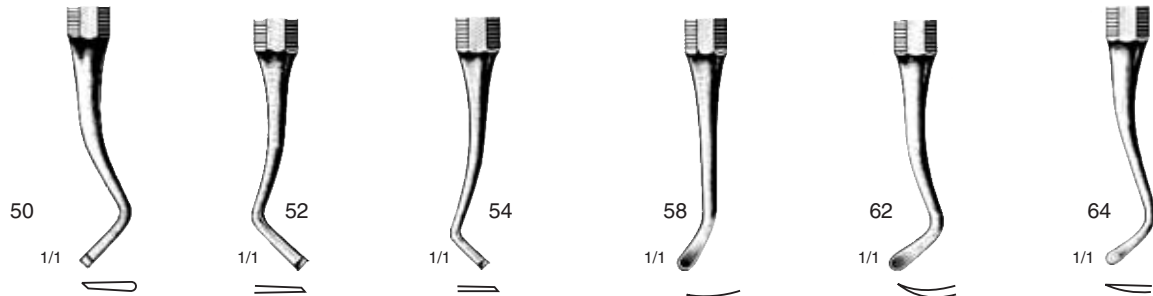
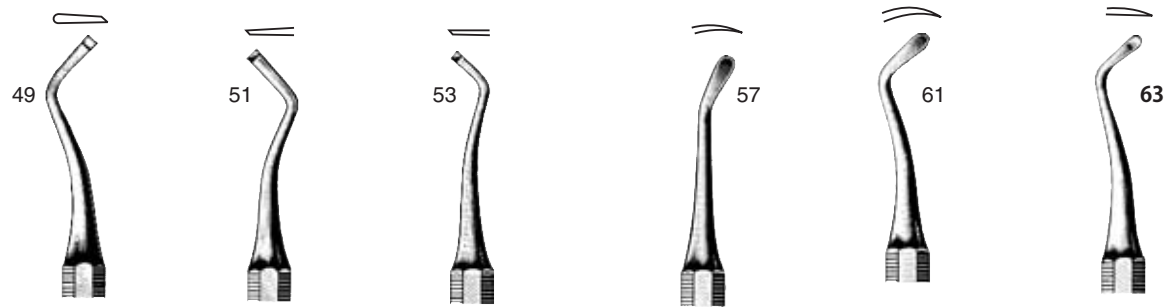

50	52	54	58	62	64
UI34-061-50	UI34-061-52	UI34-061-54	UI34-061-58	UI34-061-62	UI34-061-64
20	15	10	15	20	15
9	8	6	8	9	8
12	12	12	6	12	12
L	L	L	L	L	L

A) Width of Blade in 1/10 mm
 B) Length of the blade in mm
 C) Angle of the blade to its handle

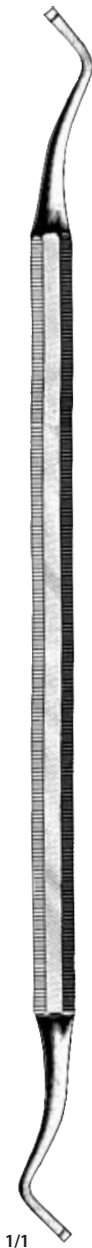
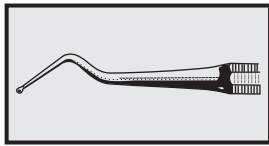

1/1

65	69	73	75	77	79
UI34-063-65	UI34-063-69	UI34-063-73	UI34-063-75	UI34-063-77	UI34-063-79
10	15	20	20	15	15
6	8	9	9	8	8
12	23	12	12	12	12
R	R	R	R	R	R

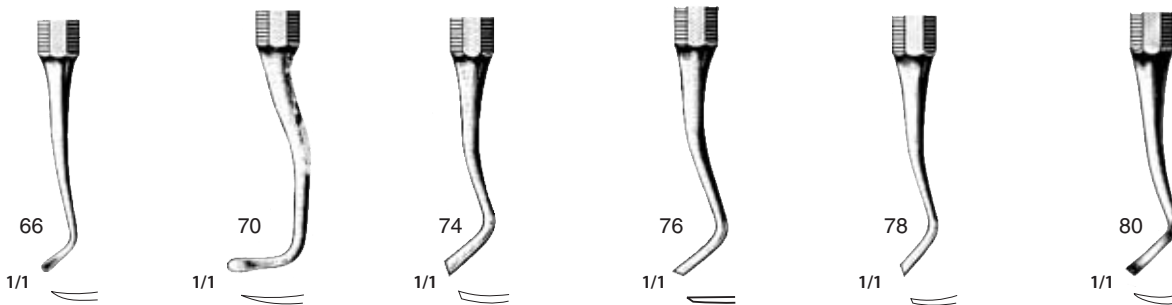
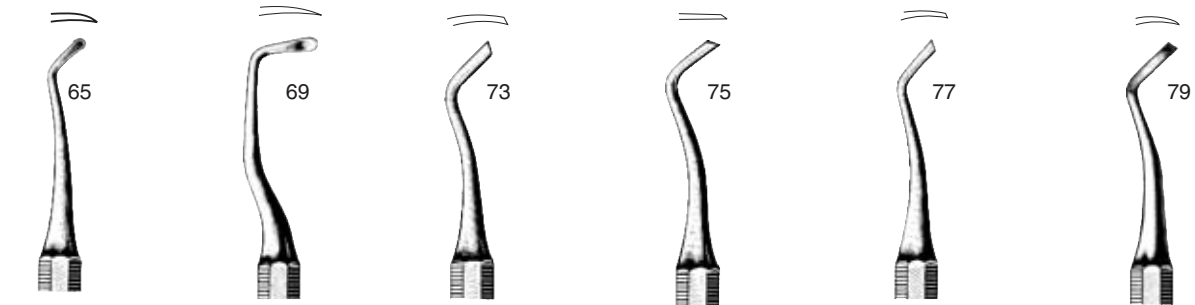

66	70	74	76	78	80
UI34-063-66	UI34-063-70	UI34-063-74	UI34-063-76	UI34-063-78	UI34-063-80
10	15	20	20	15	15
6	8	9	9	8	8
12	23	12	12	12	12
L	L	L	L	L	L

A) Width of Blade in 1/10 mm
 B) Length of the blade in mm
 C) Angle of the blade to its handle

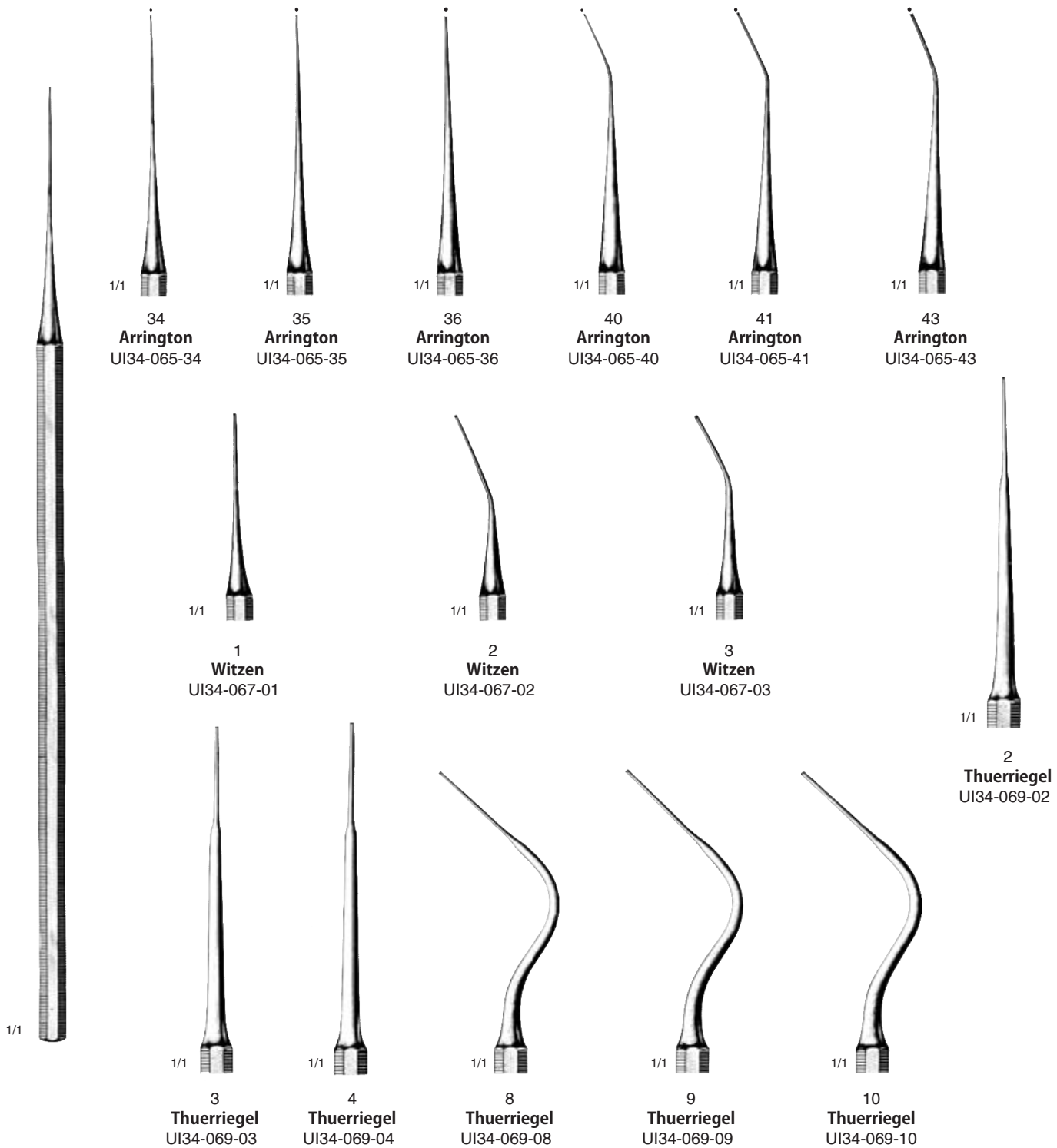
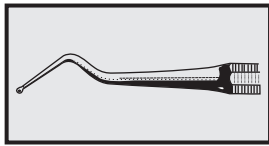

UI34-065-34	UI34-065-43	Nerve Extractors, Spring tempered
UI34-067-01	UI34-067-03	Nerve and Root-Canal Pluggers
UI34-069-02	UI34-069-10	Nerve and Root-Canal Pluggers

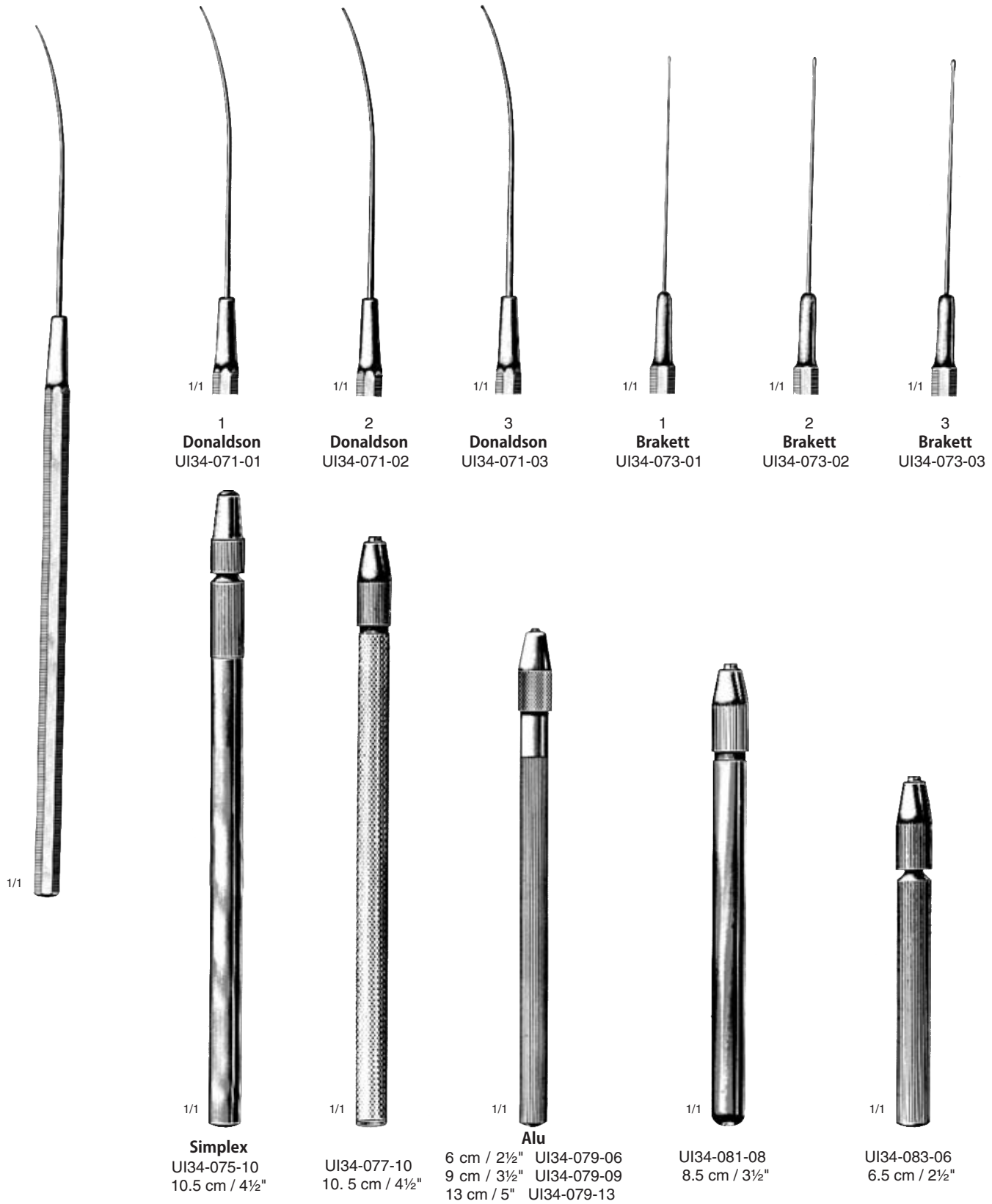
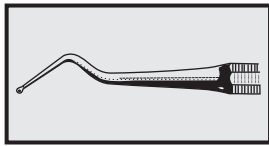

UI34-071-01	UI34-071-03	Nerve Canal Pluggers
UI34-073-01	UI34-073-03	Abscess and Fistula Probes

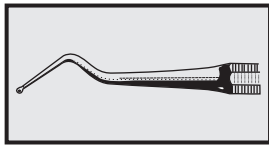

Abbott
UI34-085-01



Marshall
UI34-089-01

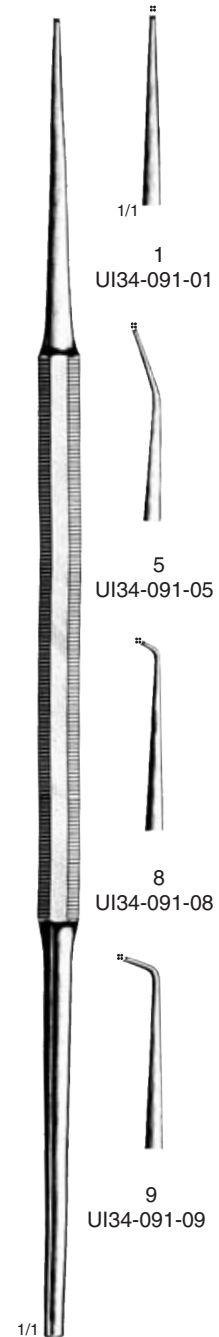

Gold Plugger

UI34-085-01	Automatic mallet	
UI34-089-01	Pellet Placer	
UI34-091-01	UI34-091-09	Gold pluggers

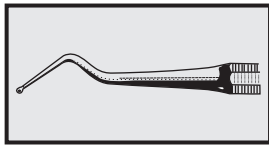

1/1
Haubeil
UI34-009-01



1/1

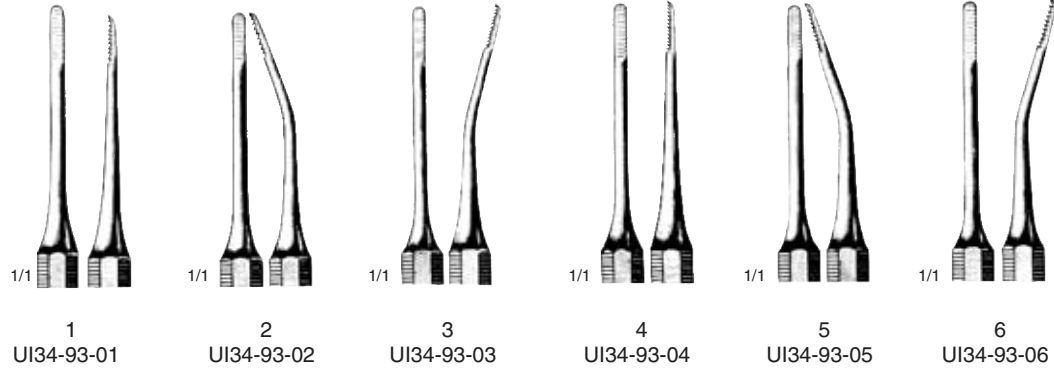

1 UI34-93-01 2 UI34-93-02 3 UI34-93-03 4 UI34-93-04 5 UI34-93-05 6 UI34-93-06

WedelstZBdt

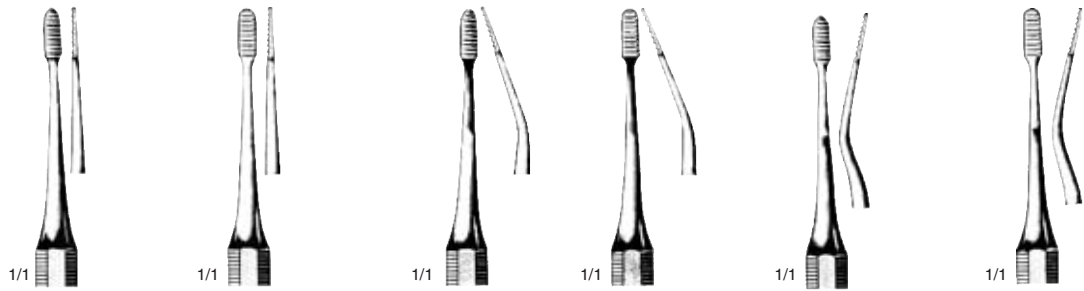

1 UI34-95-01 2 UI34-95-02 3 UI34-95-03 4 UI34-95-04 5 UI34-95-05 6 UI34-95-06

Black

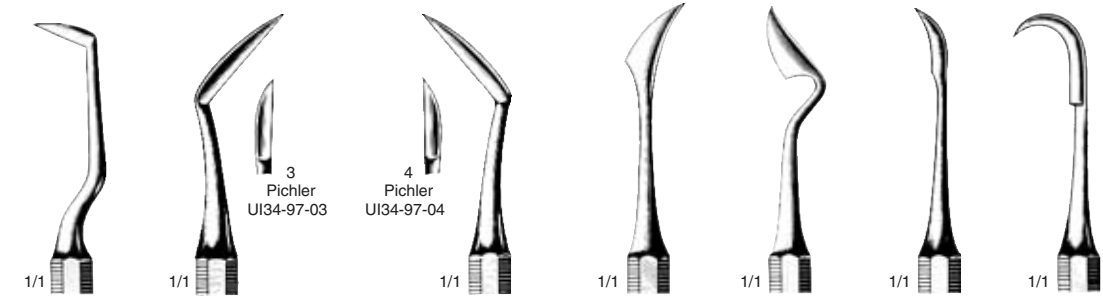

8 **Black** UI34-95-08 1 **Pichler** UI34-97-01 3 **Pichler** UI34-97-03 4 **Pichler** UI34-97-04 1 UI34-99-01 2 UI34-99-02 1 UI34-99-01 2 UI34-99-02

UI34-93-01	UI34-95-06	Finishing Files
UI34-95-08	UI34-99-02	Finishing Knives

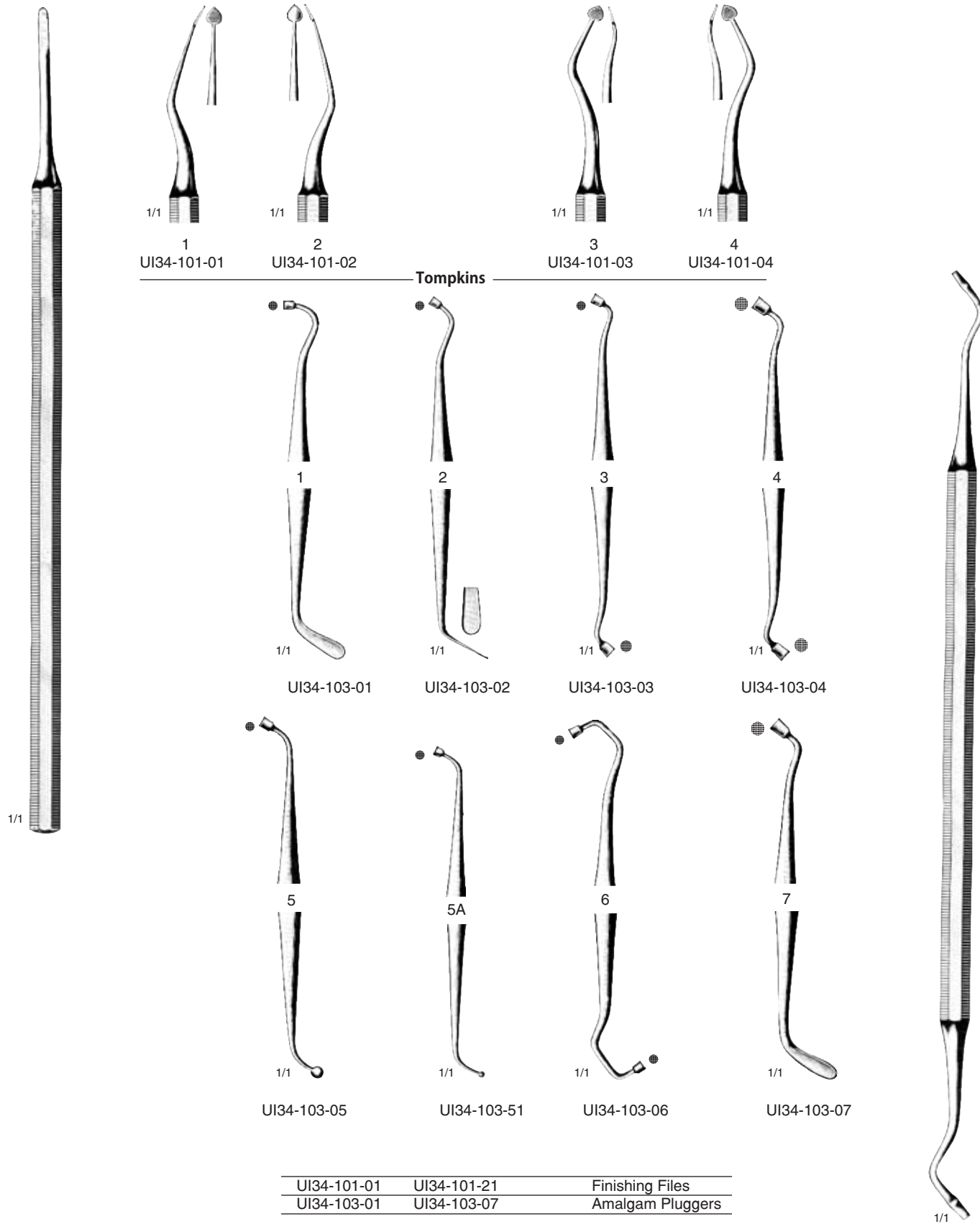
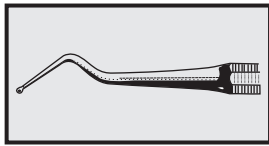

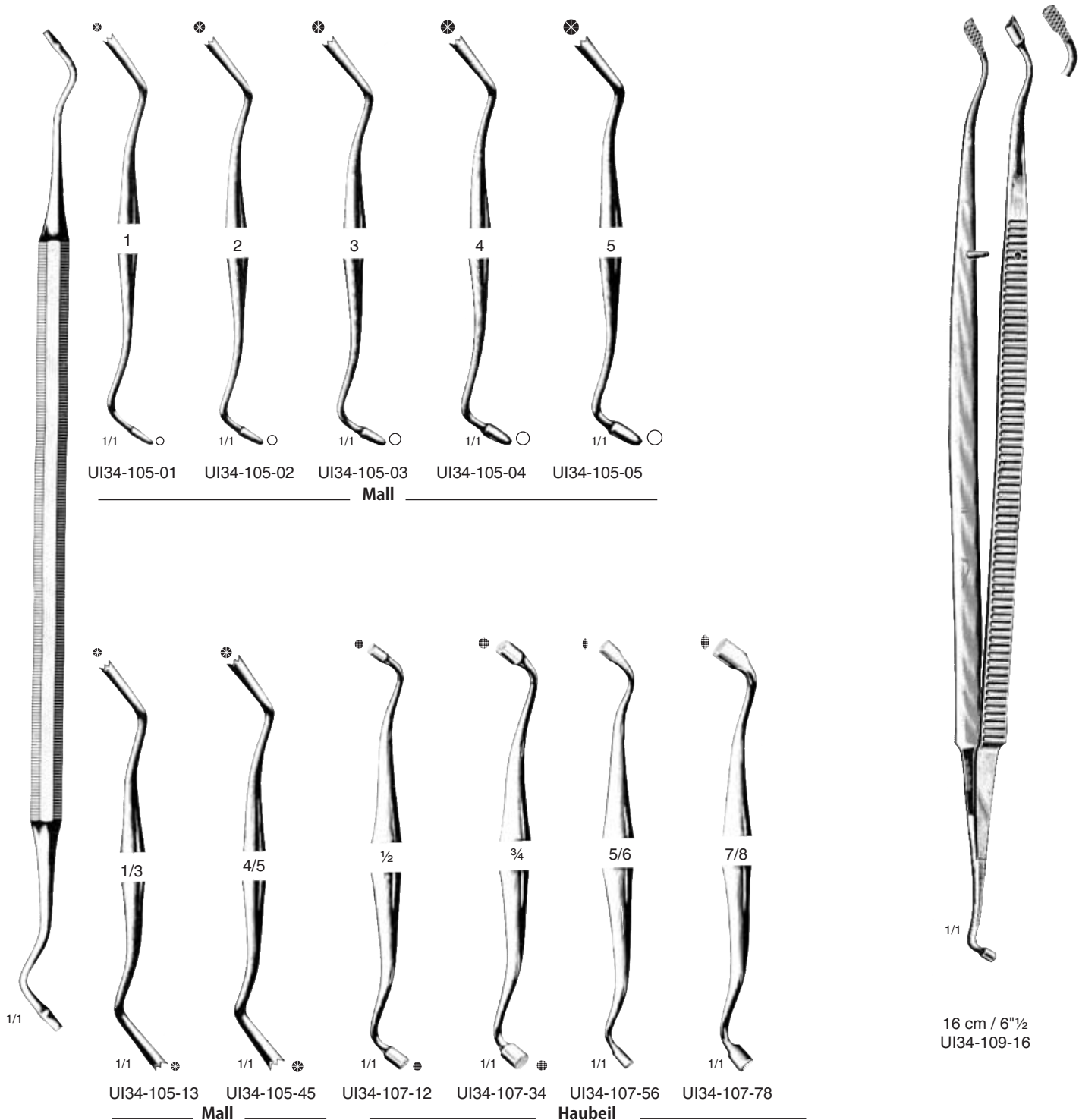
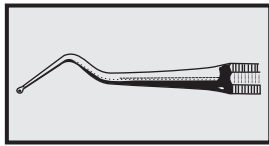

UI34-107-78	UI34-105-01	Amalgam Pluggers
	UI34-109-02	Amalgam Spetula
	UI34-111-16	Amalgam Plugging Pliers

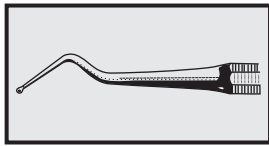

URIYA Instruments®

Instruments for Amalgam, Gutta-Percha and Cement

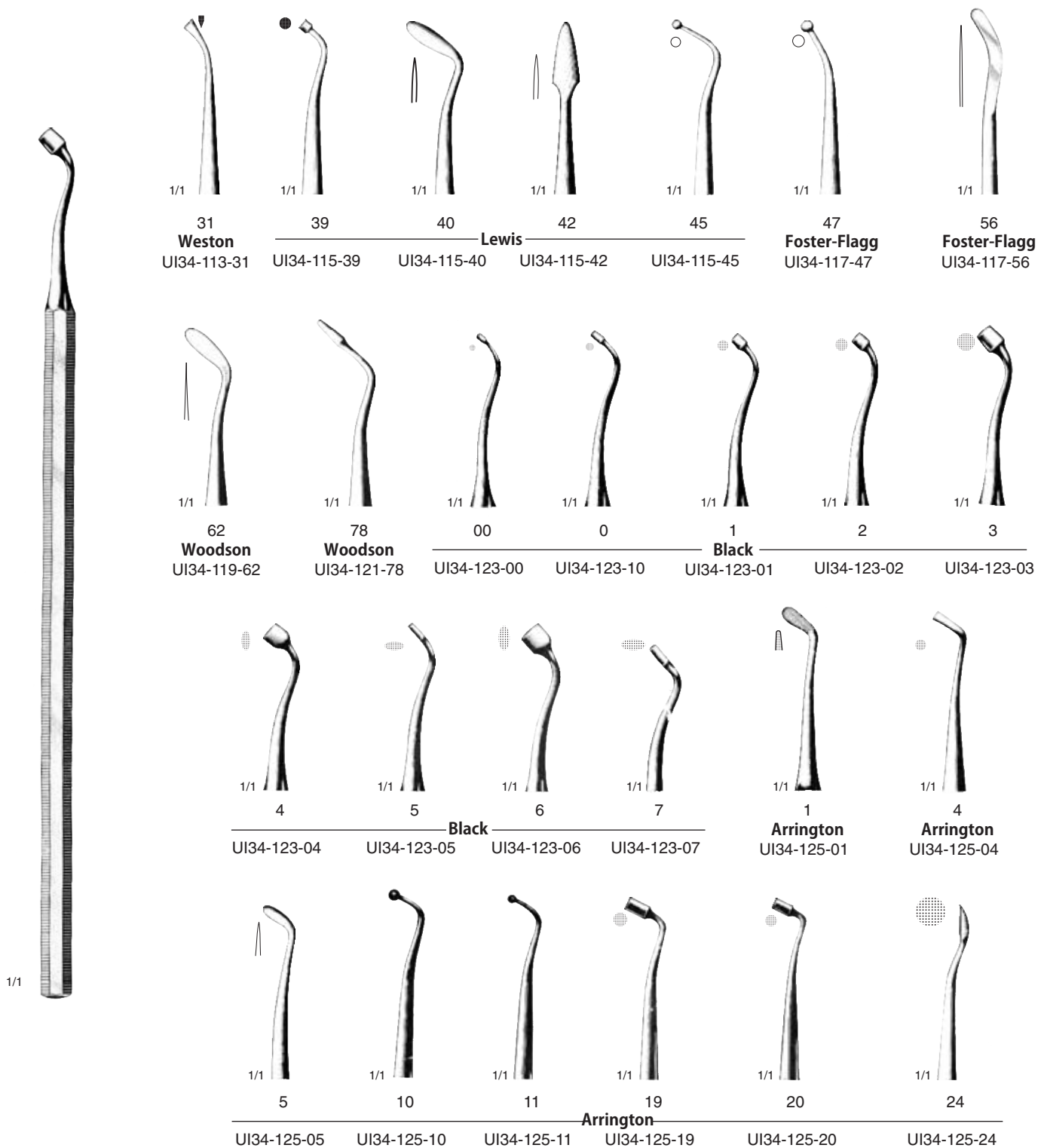

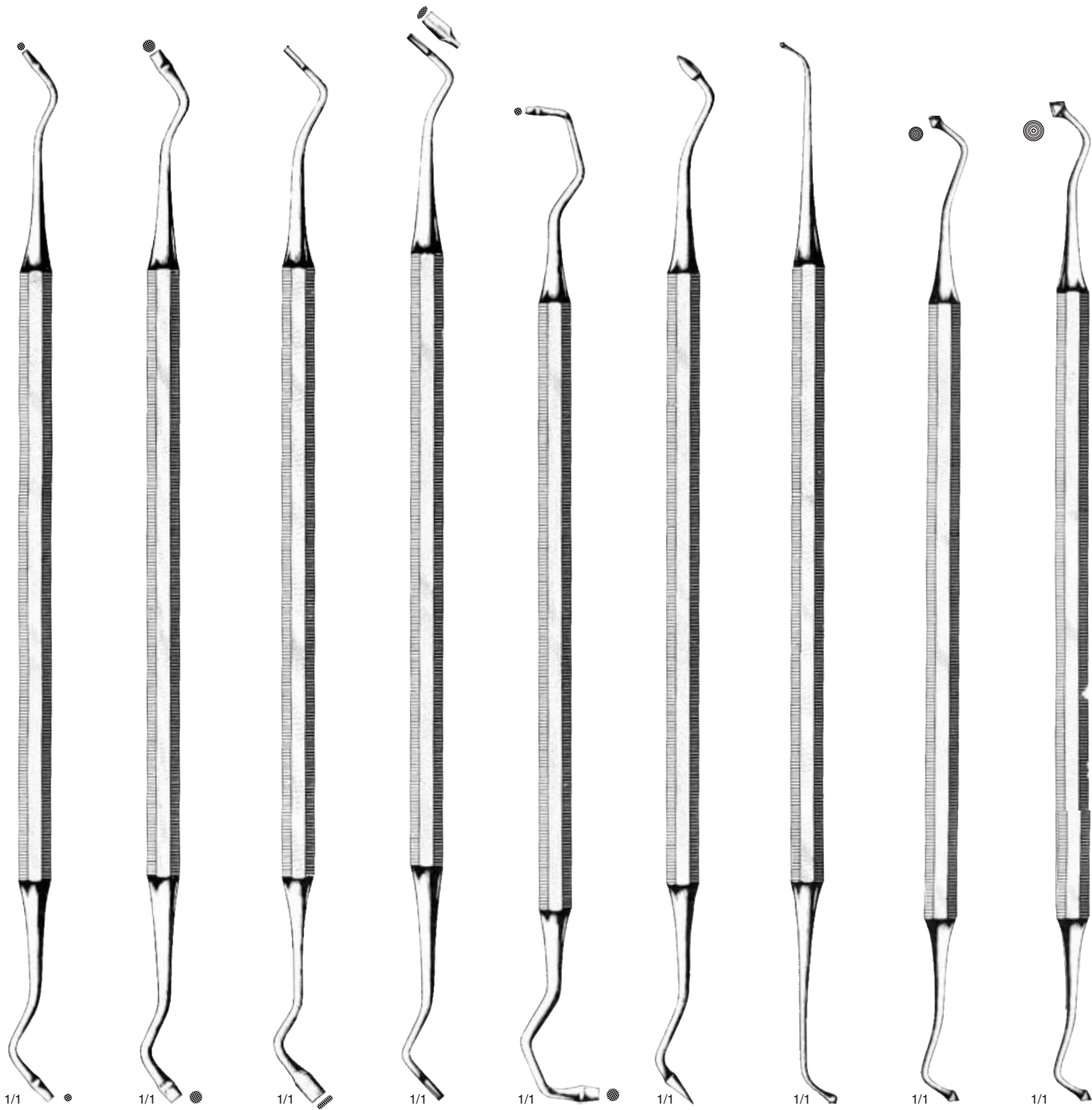
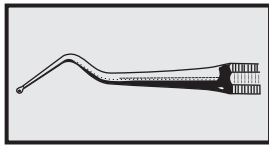

1/1 1/1 1/1 1/1 1/1 1/1 1/1 1/1 1/1

UI34-126-01 UI34-126-02 UI34-126-03 **Hollenback** UI34-126-04 UI34-126-05 UI34-126-06 UI34-126-07 **Mod. USA** UI34-127-01 **Mod. USA** UI34-127-02

UI34-126-01 UI34-127-02 Amalgam Condensers, Double-ended

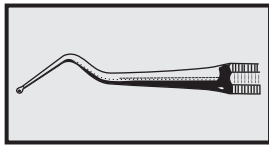

1/1
Pallas
UI34-128-01



1/1
UI34-129-01



1/1
Elliot
UI34-130-01

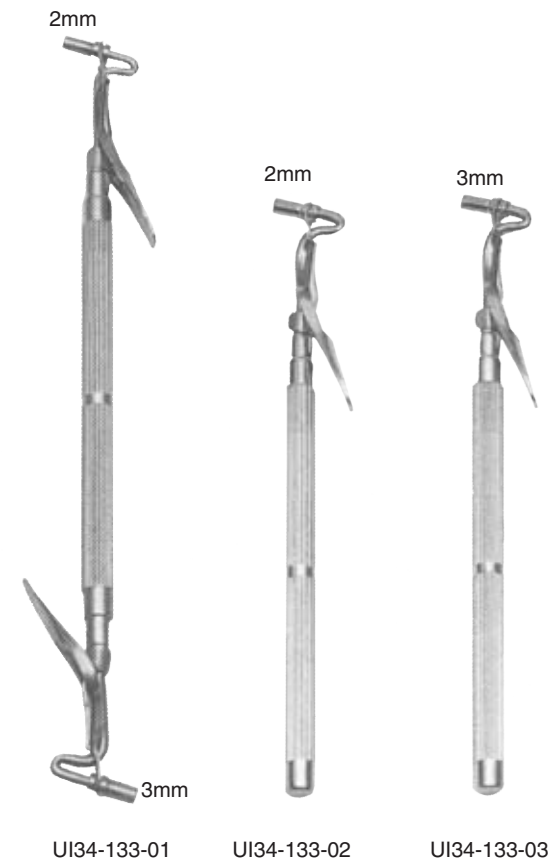
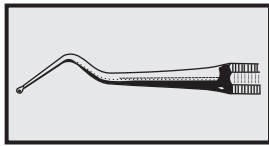

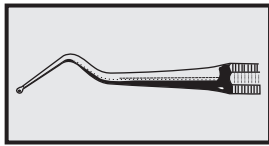

2/3

UI34-134-01
30 mm Ø



2/3

UI34-134-02
30 mm Ø



2/3

UI34-135-01



1/1

UI34-136-01

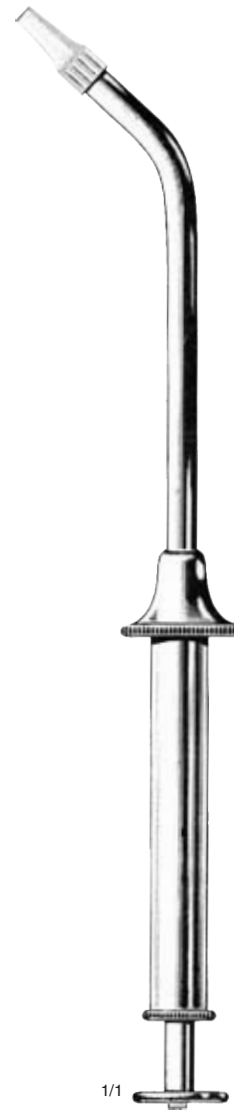

1/1

UI34-137-01



1/1

UI34-138-01

UI34-133-01	UI34-134-01	Finger Cups for pumice, amalgam, grinding paste
UI34-135-01		Mercury dispenser
UI34-136-01	UI34-138-01	Amalgam Guns

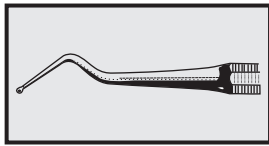

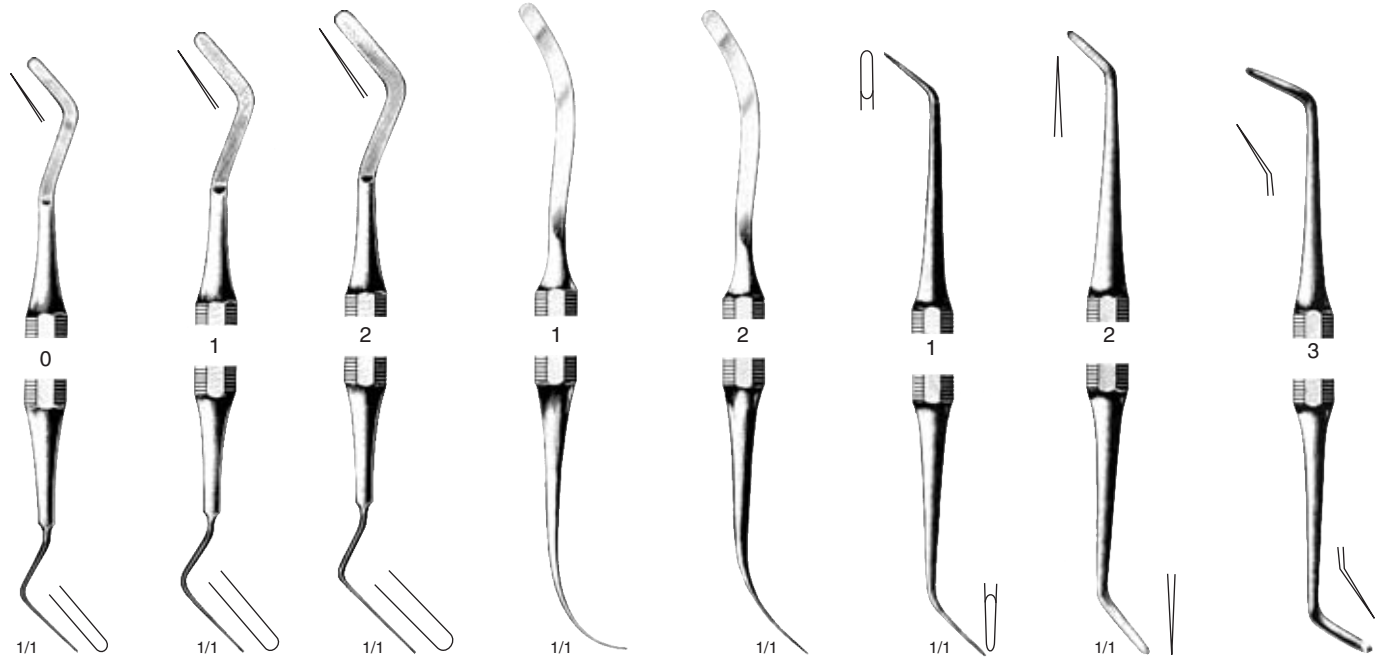
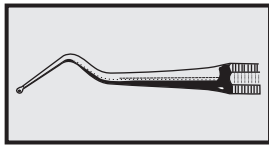

Heidemann
UI34-145-00 UI34-145-01 UI34-145-02

Moesle
UI34-147-01 UI34-147-02

Messer
UI34-149-01 UI34-149-02 UI34-149-03

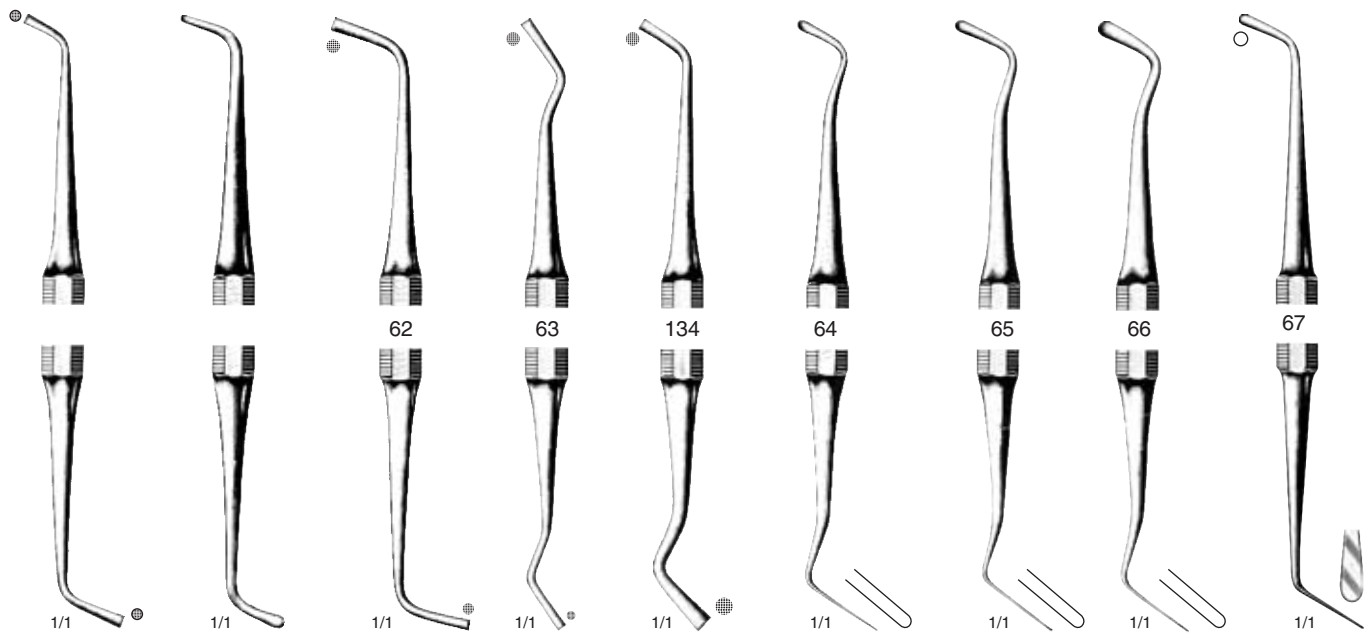

Smith
UI34-151-01

Baldwin
UI34-153-01

Edwards
UI34-155-62 UI34-155-63 UI34-155-34

Ash
UI34-157-64 UI34-157-65 UI34-157-66 UI34-157-67

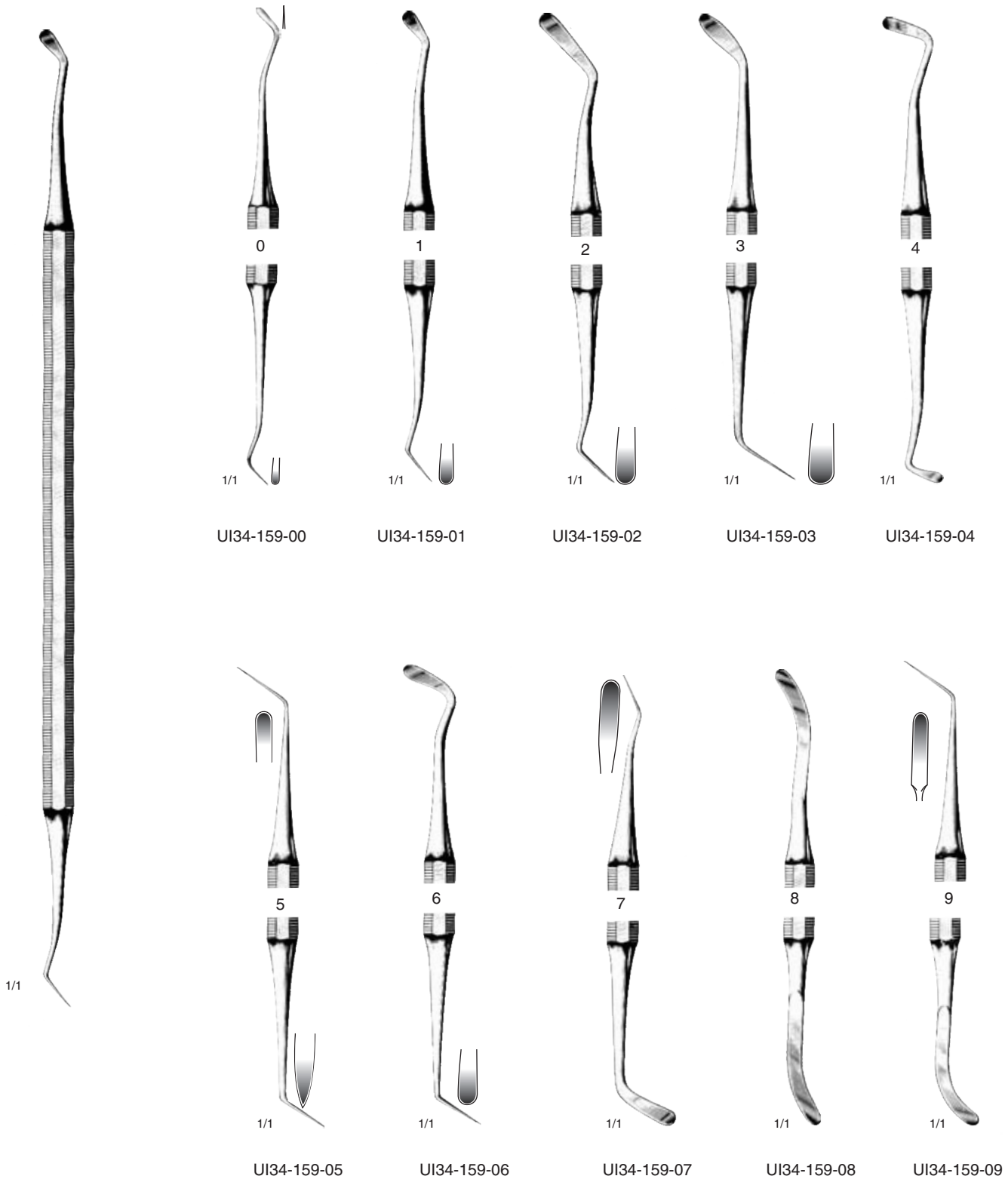
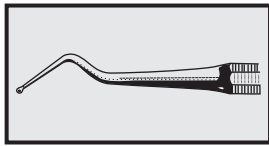

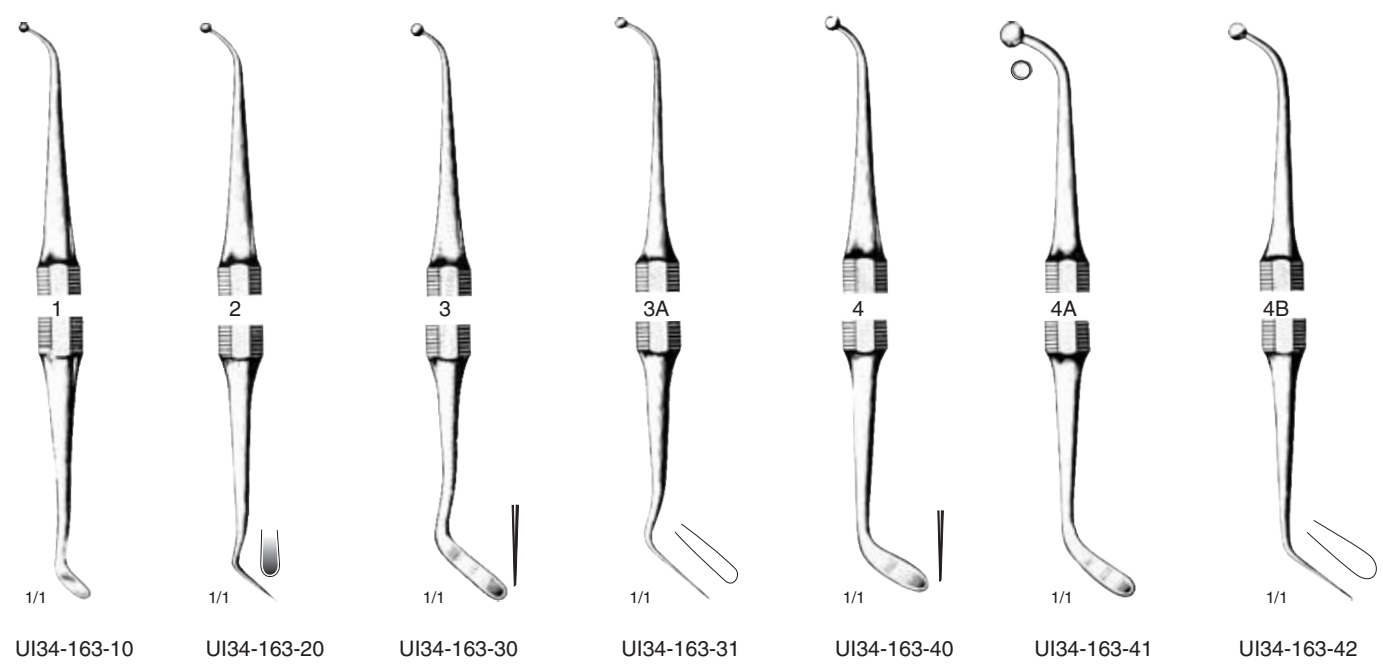
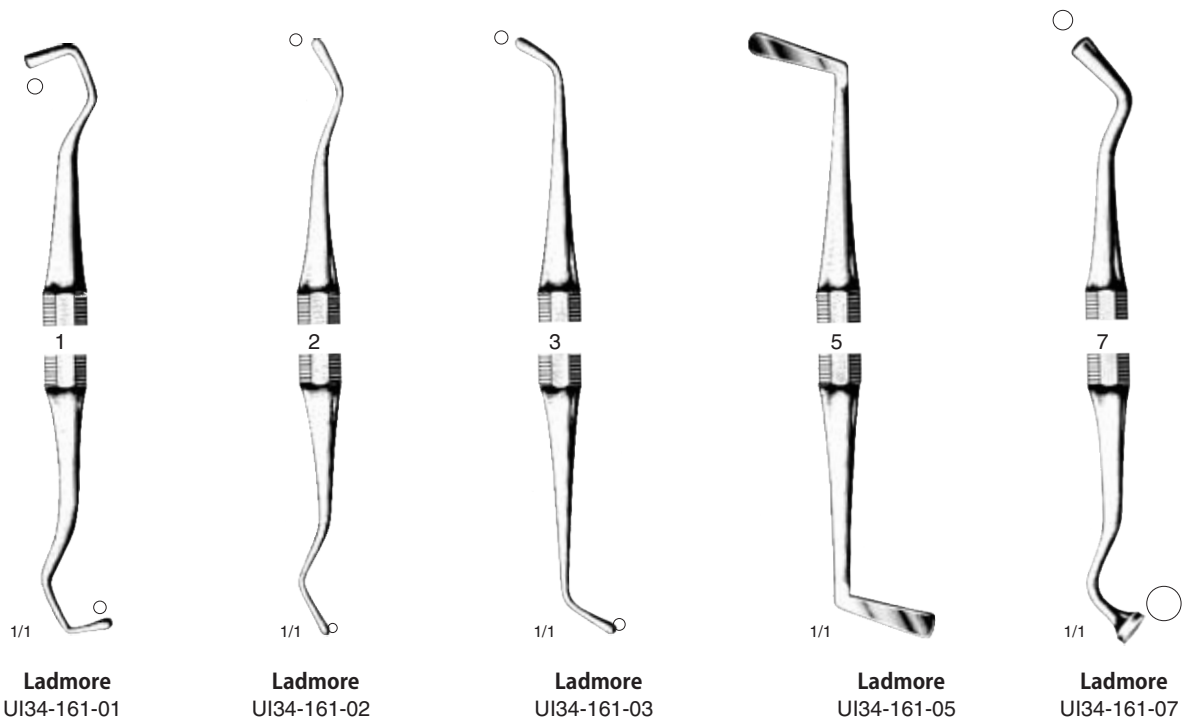
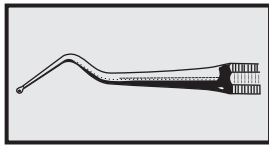

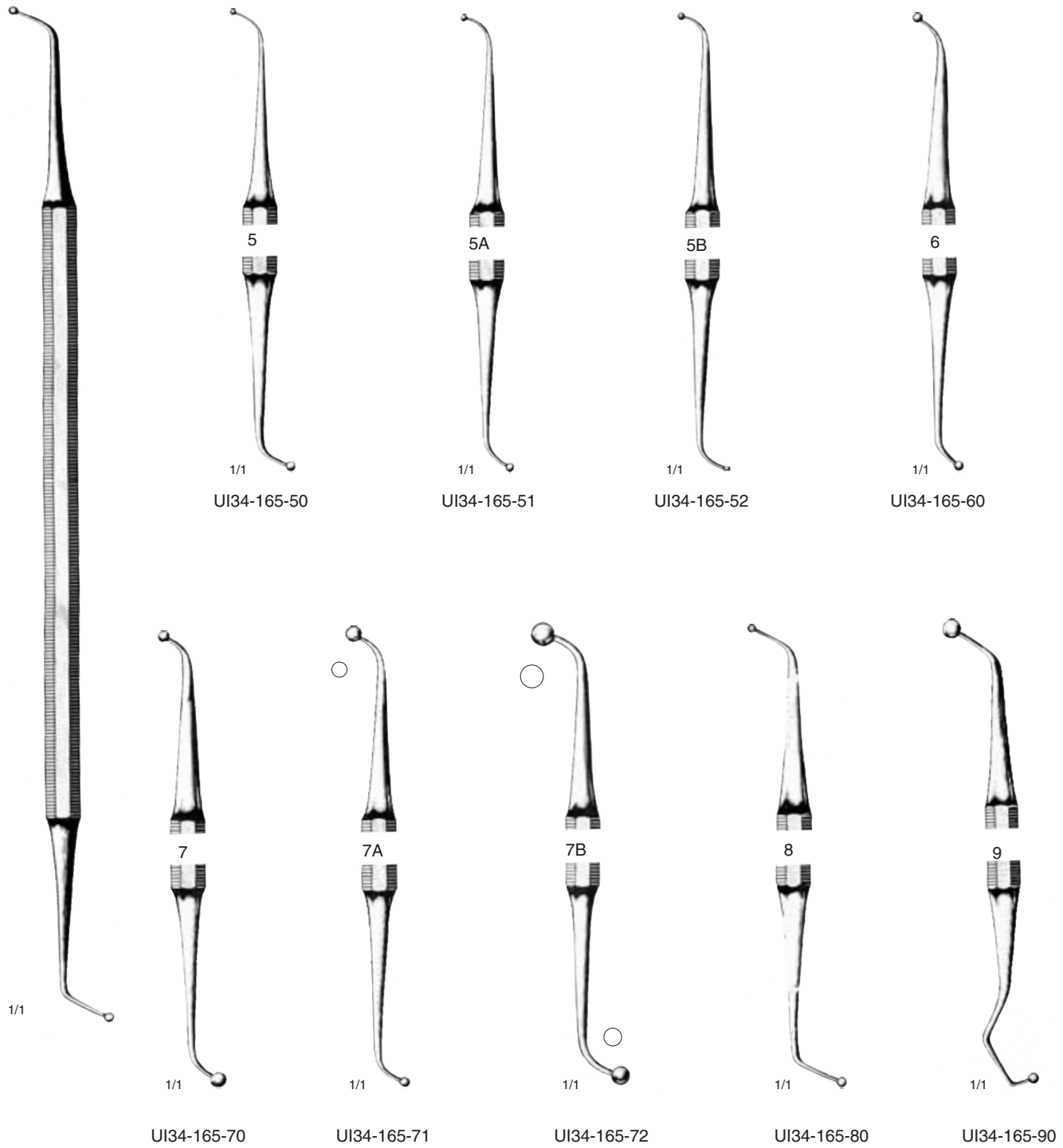
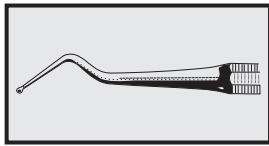

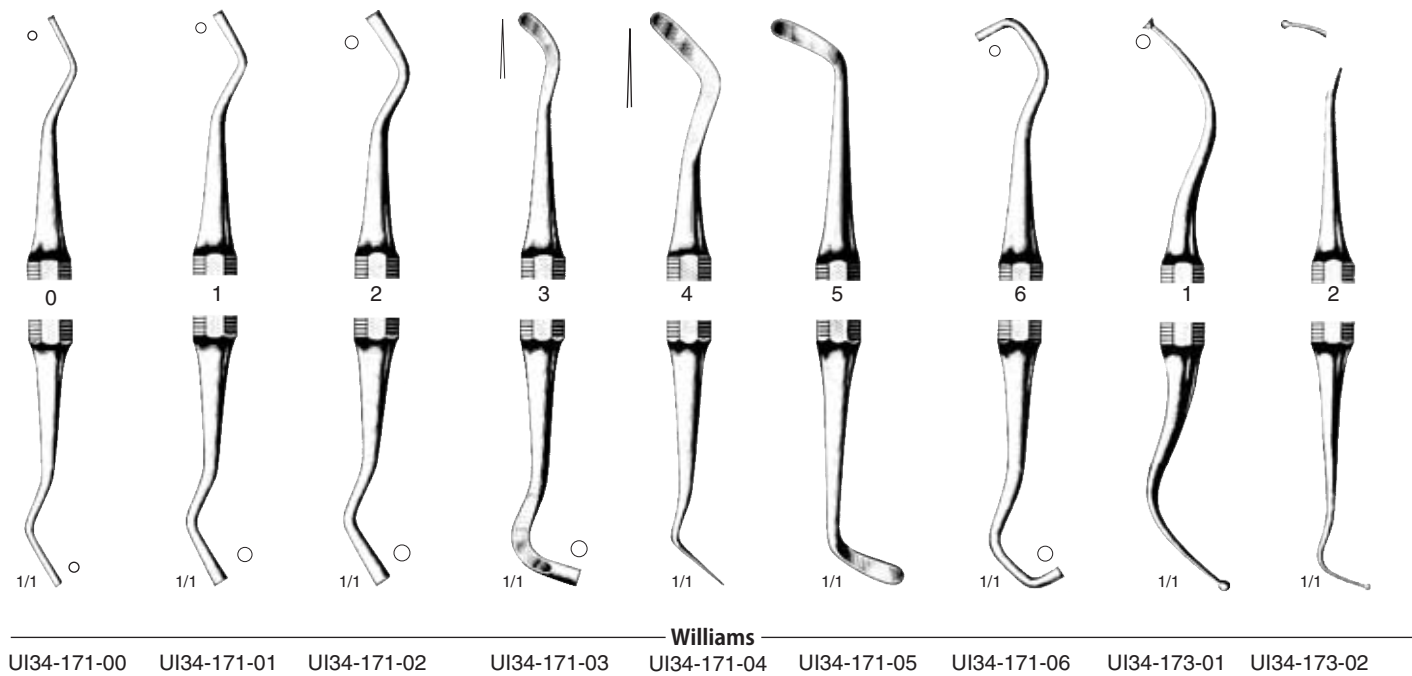
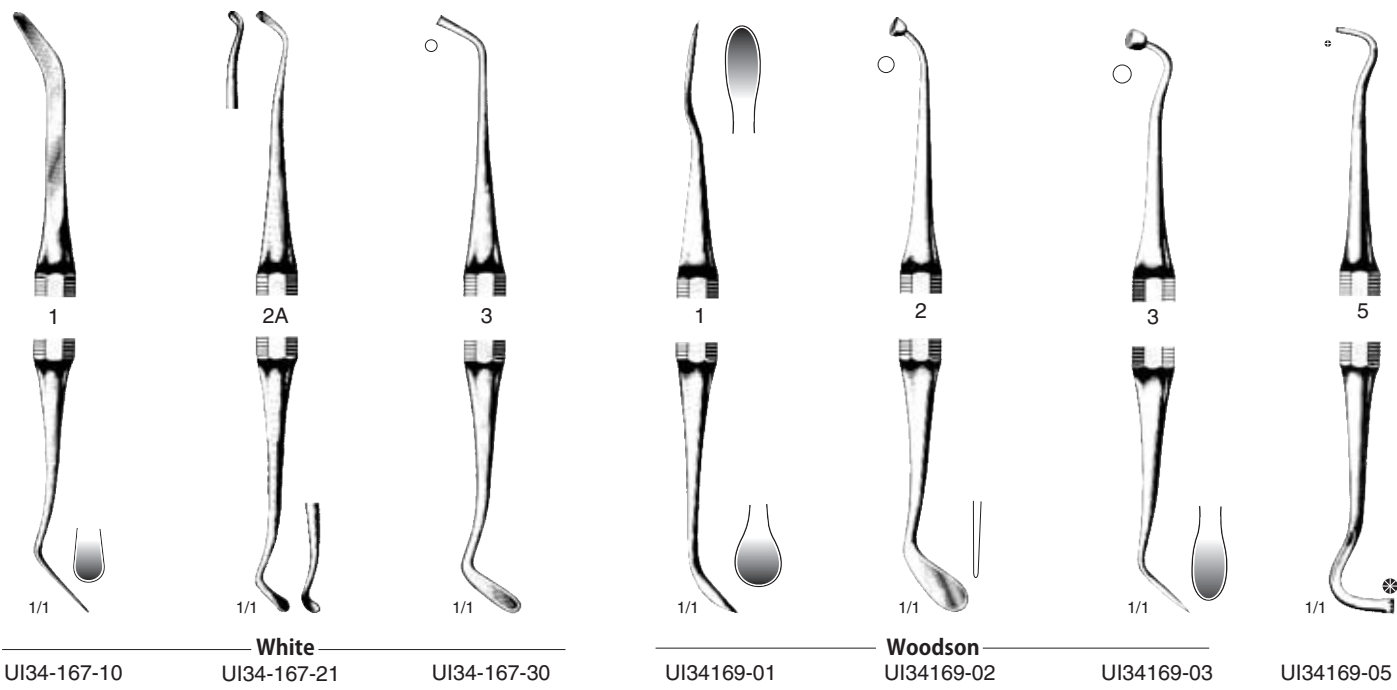
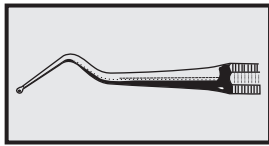

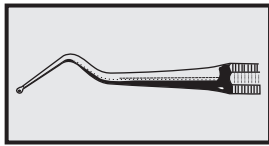

9



1/1

UI34-175-90



10



1/1

UI34-175-10



11



1/1

UI34-175-11



12



1/1

UI34-175-12



13



1/1

UI34-175-13



14



1/1

UI34-175-14



15



1/1

UI34-175-15



16



1/1

UI34-175-16



17



1/1

UI34-175-17



18



1/1

UI34-175-18



19



1/1

UI34-175-19

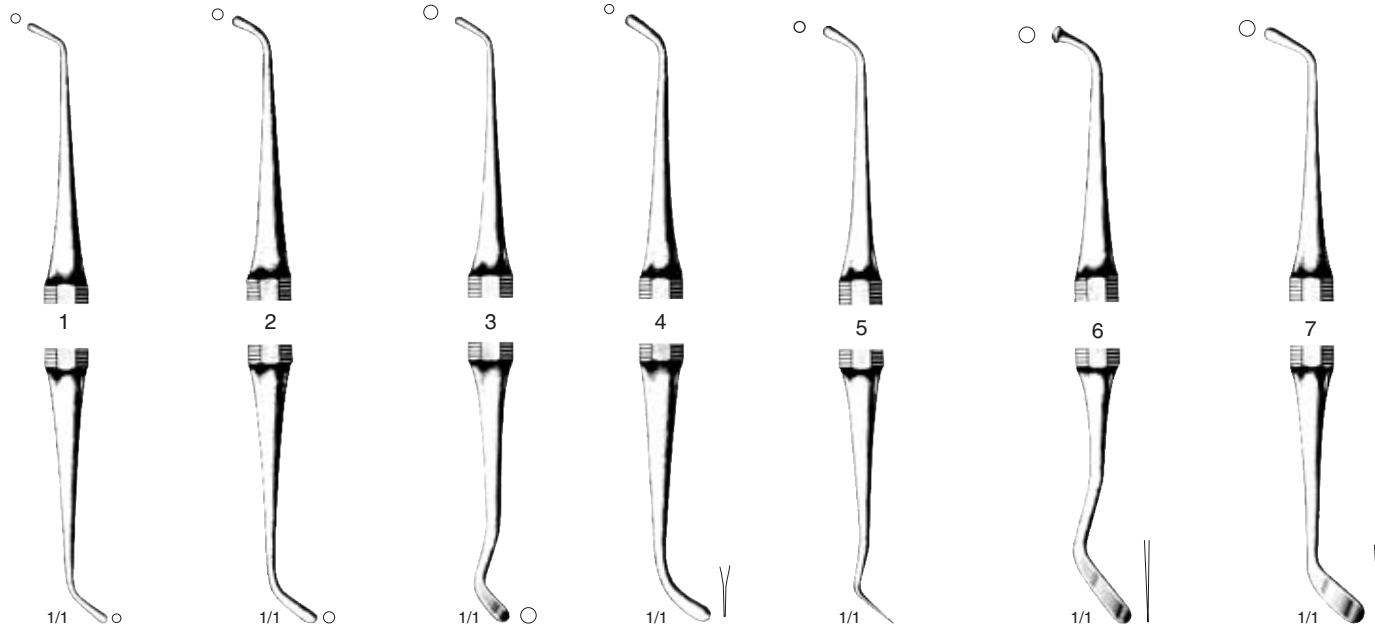
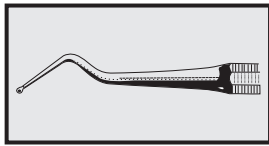

Ash

UI34-177-01

UI34-177-02

UI34-177-03

UI34-177-04

UI34-177-05

UI34-177-06

UI34-177-07

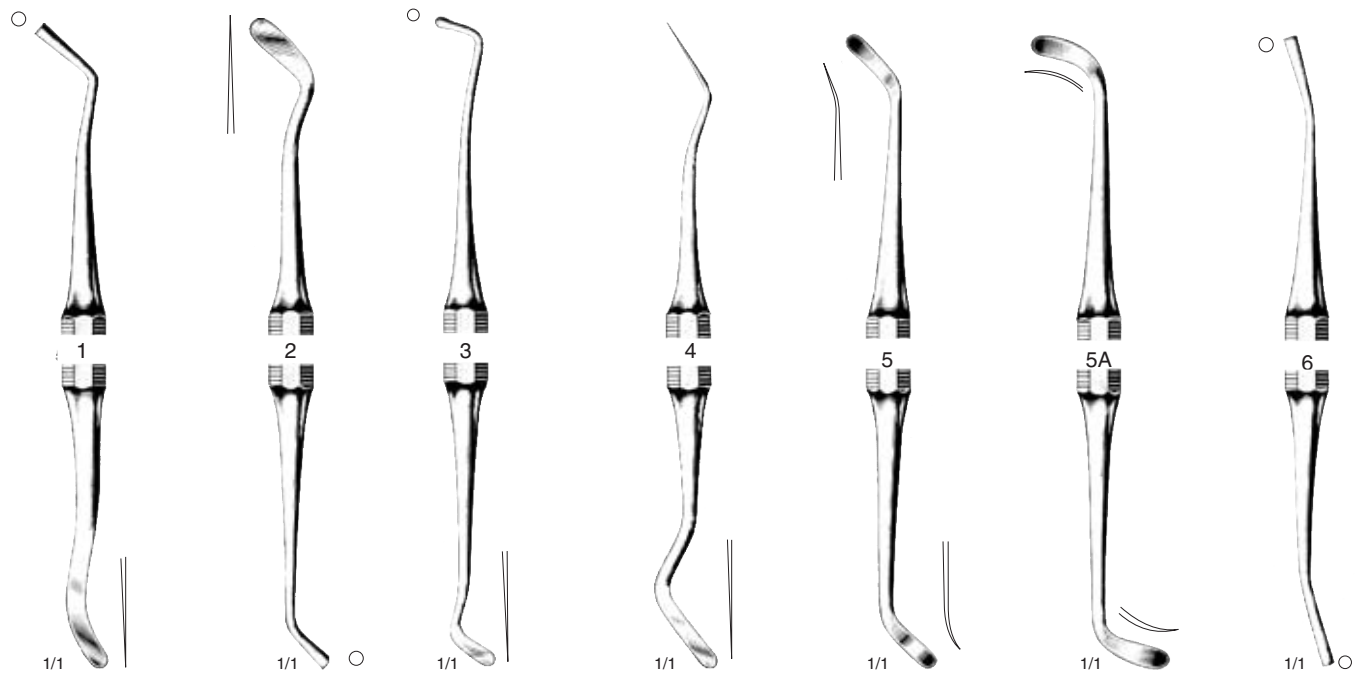

White

UI34-179-01

UI34-179-02

UI34-179-03

UI34-179-04

UI34-179-05

UI34-179-51

UI34-179-06

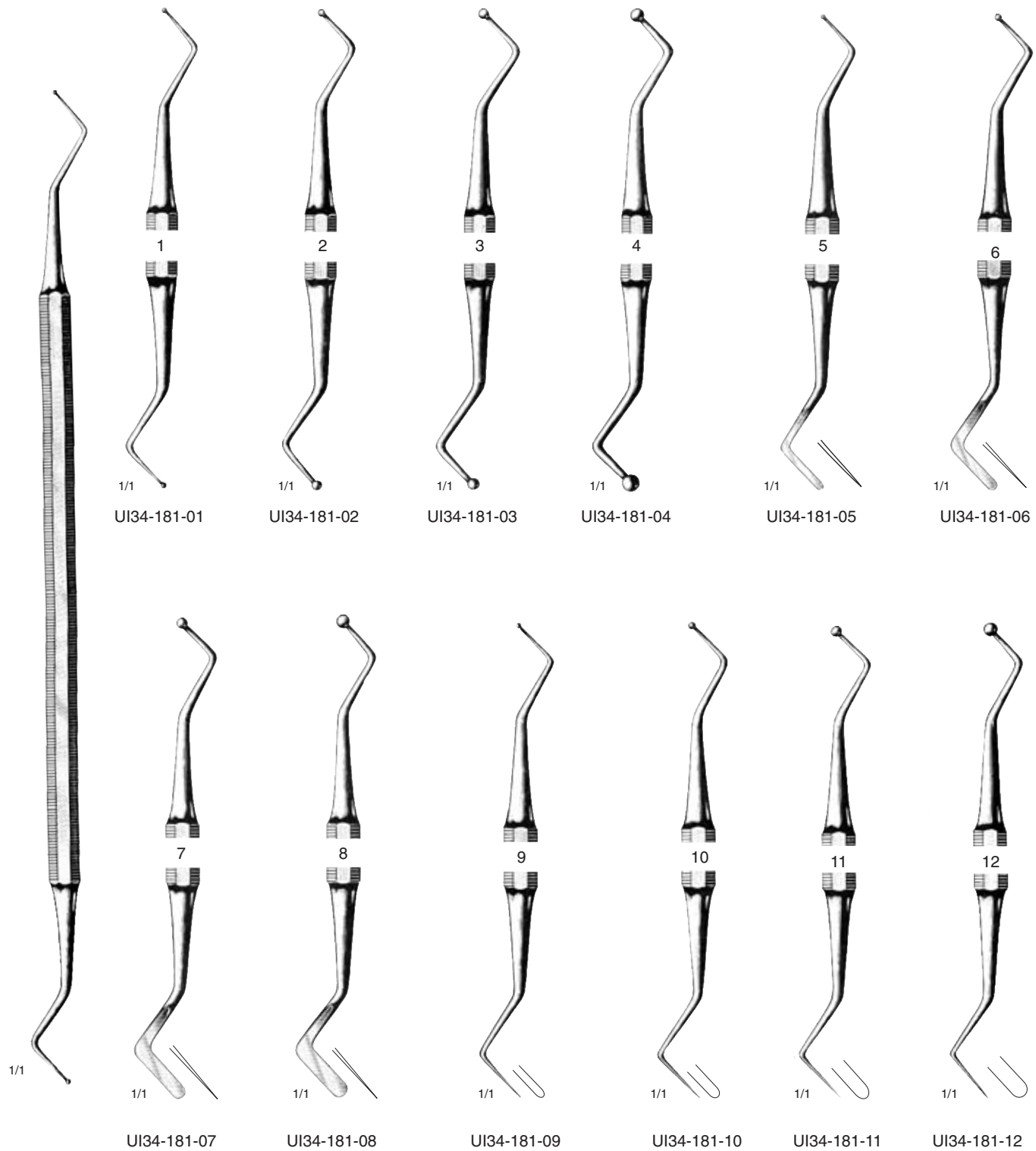
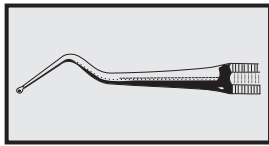

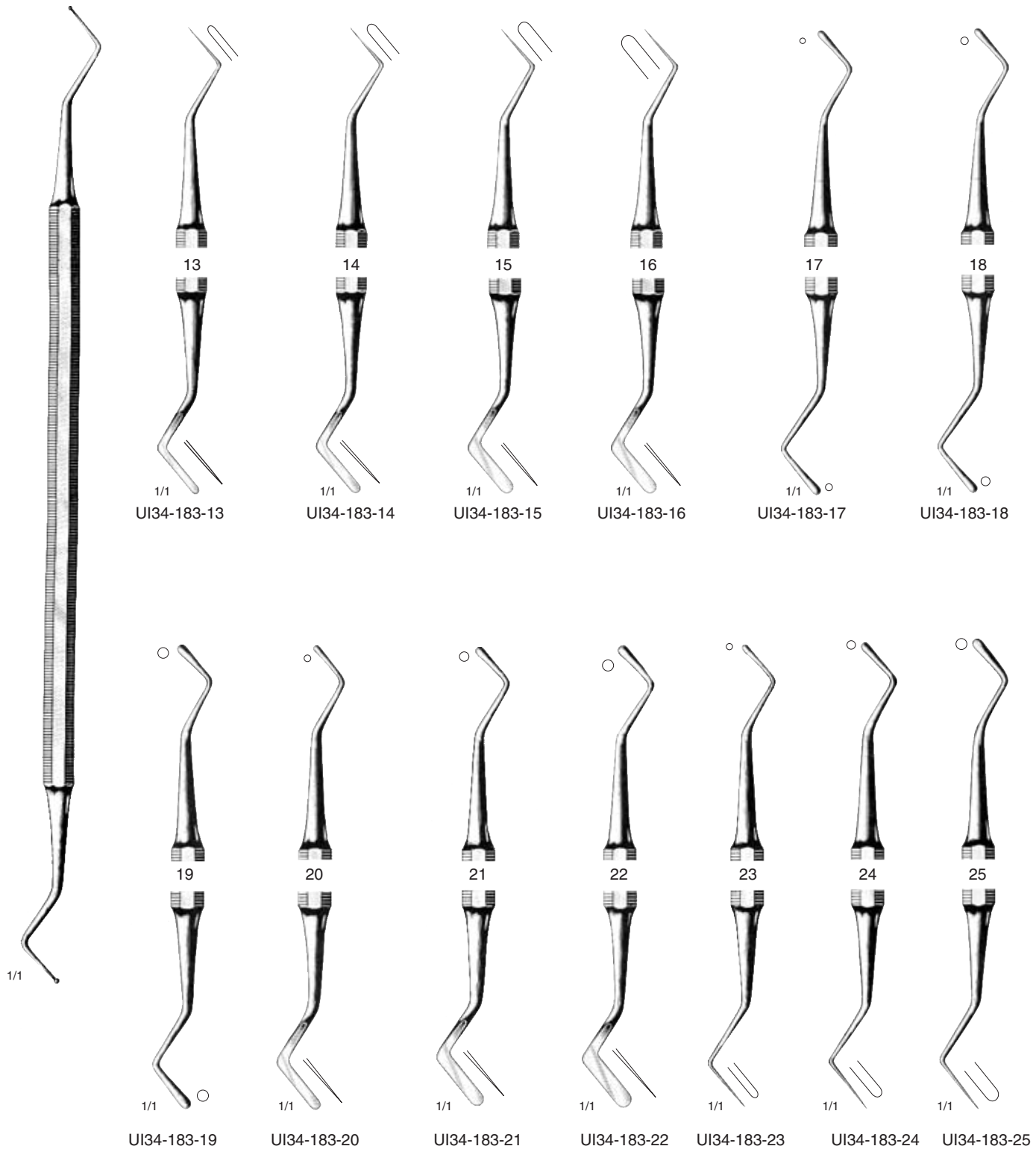
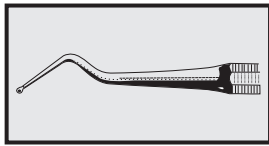

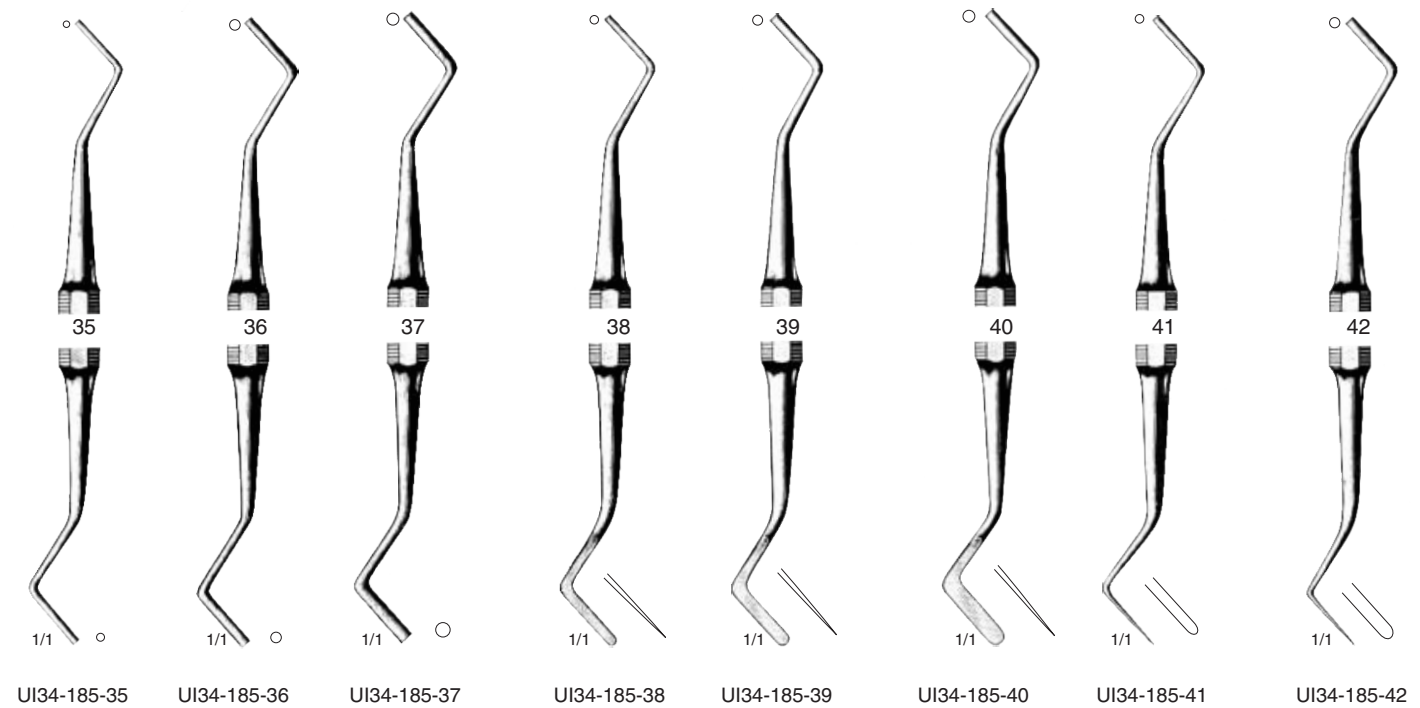
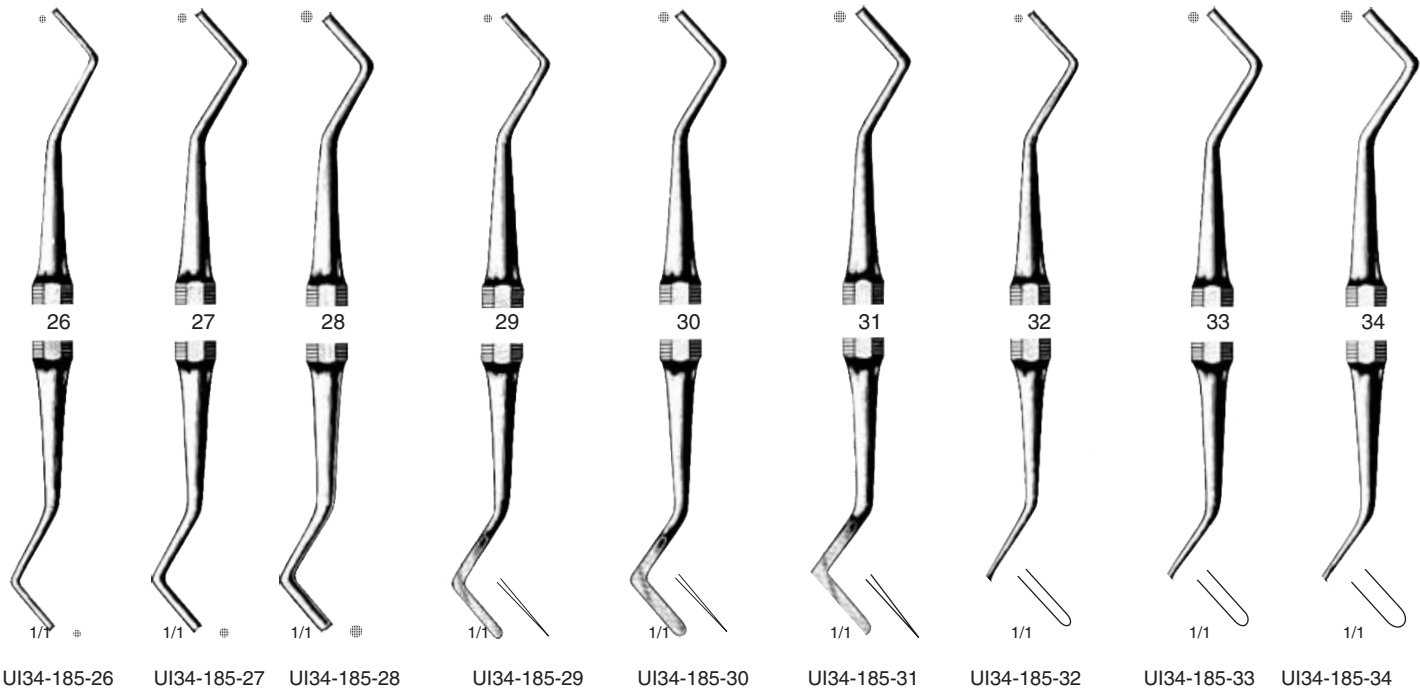
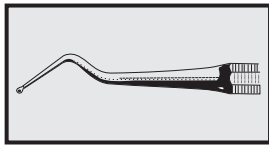

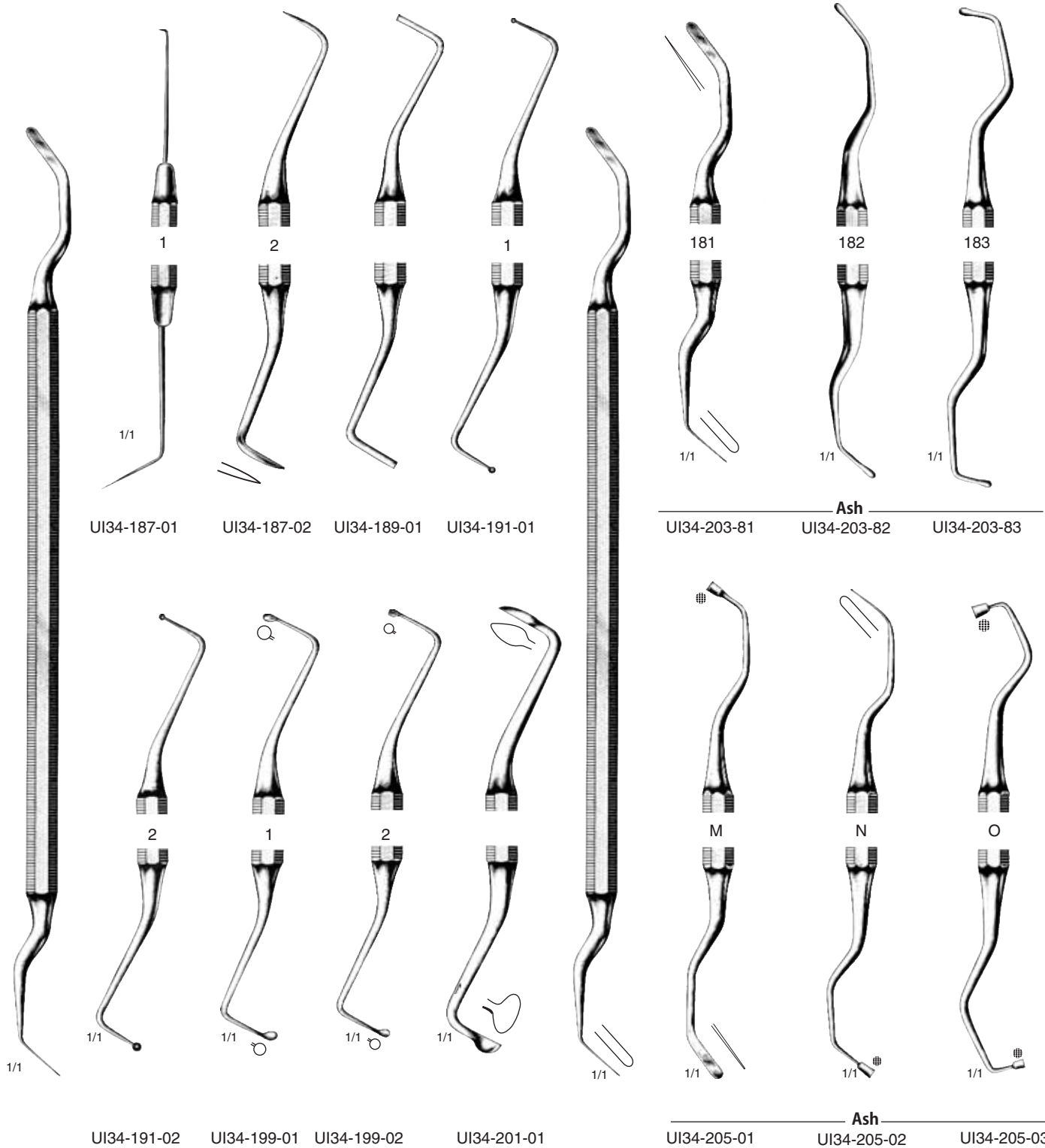
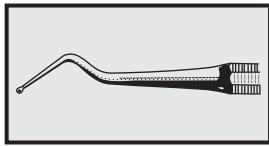

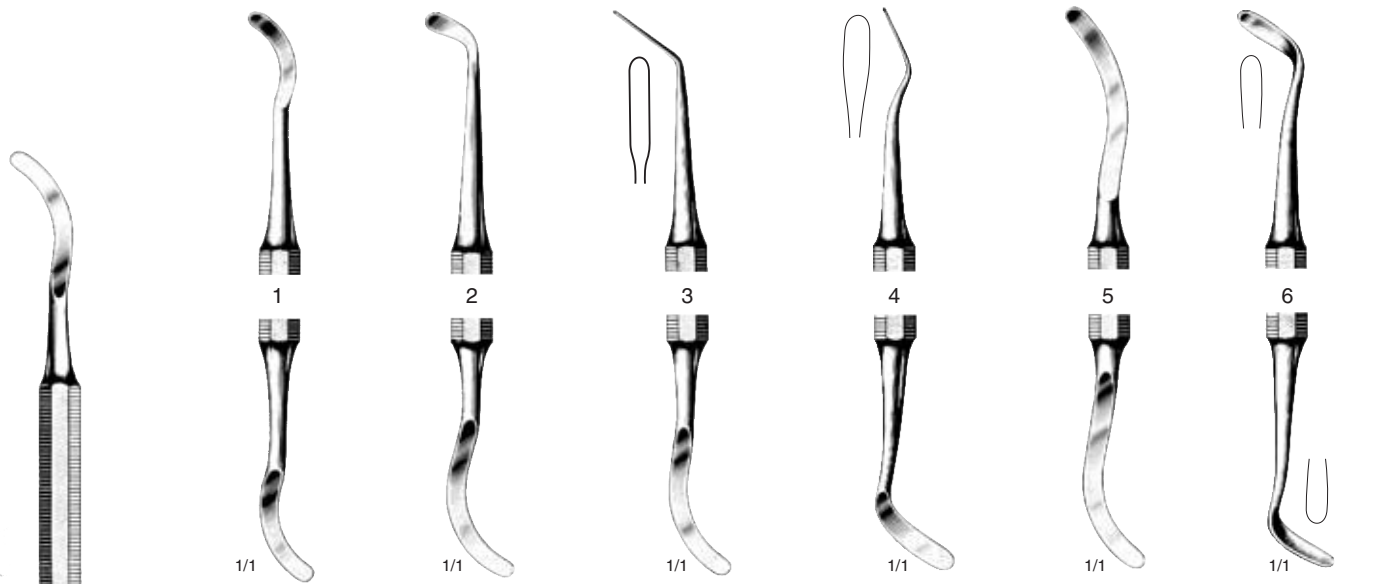
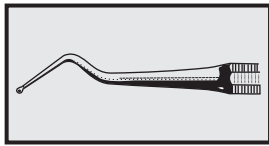

Linsemann
UI34-207-01 UI34-207-02 UI34-207-03 UI34-207-04 UI34-207-05 UI34-207-06

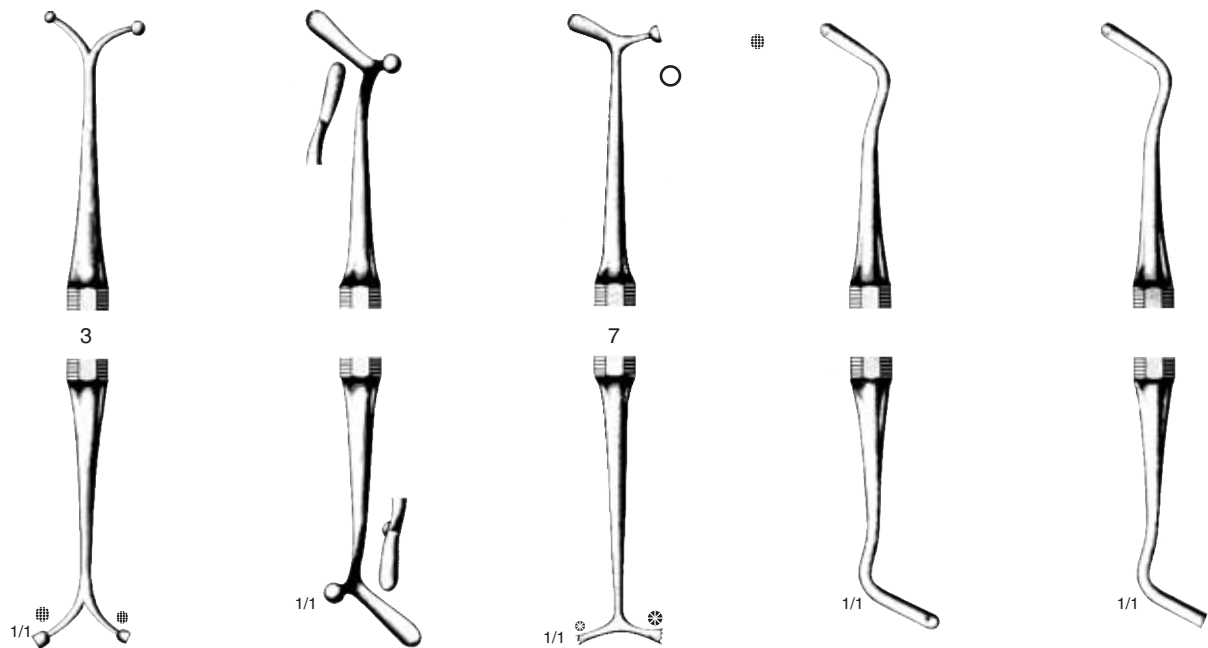

Vajna **Vajna** **Bennet**
UI34-209-03 UI34-211-01 UI34-213-07 UI34-215-01 UI34-217-02

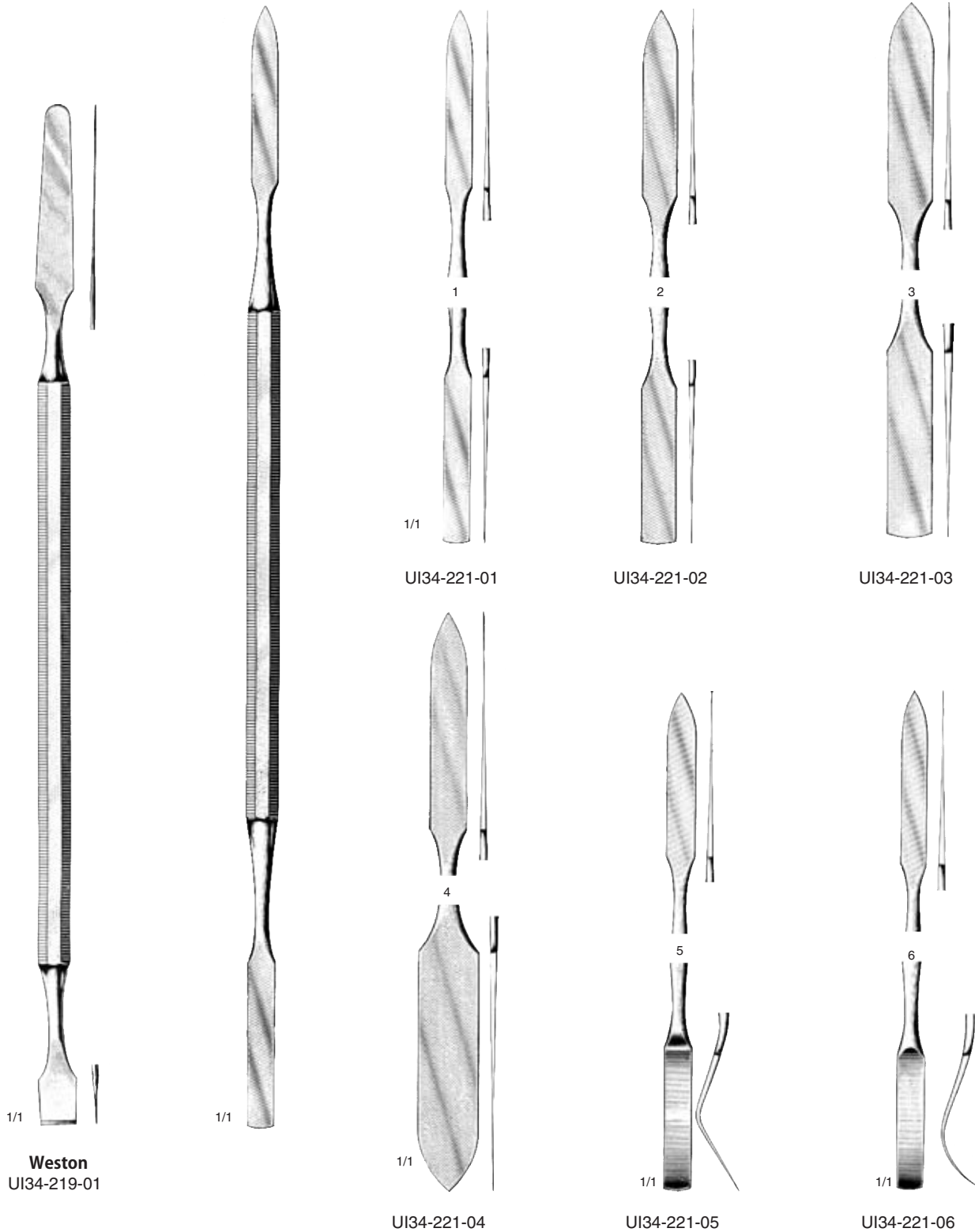
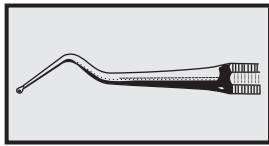

UI34-219-01 UI34-221-05 Cement Spatula

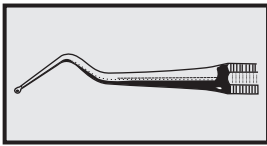

1/1

UI34-223-01



1/1

UI34-225-01



1/1

Mall-Roundoflex



1

1/1

UI34-227-01



2

UI34-227-02

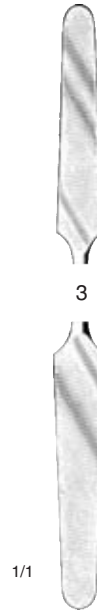

3

1/1

UI34-227-03

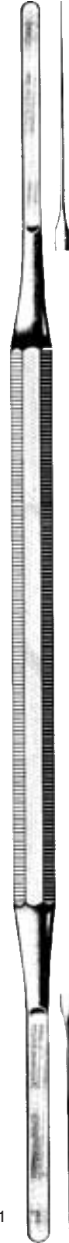

1/1

UI34-229-01

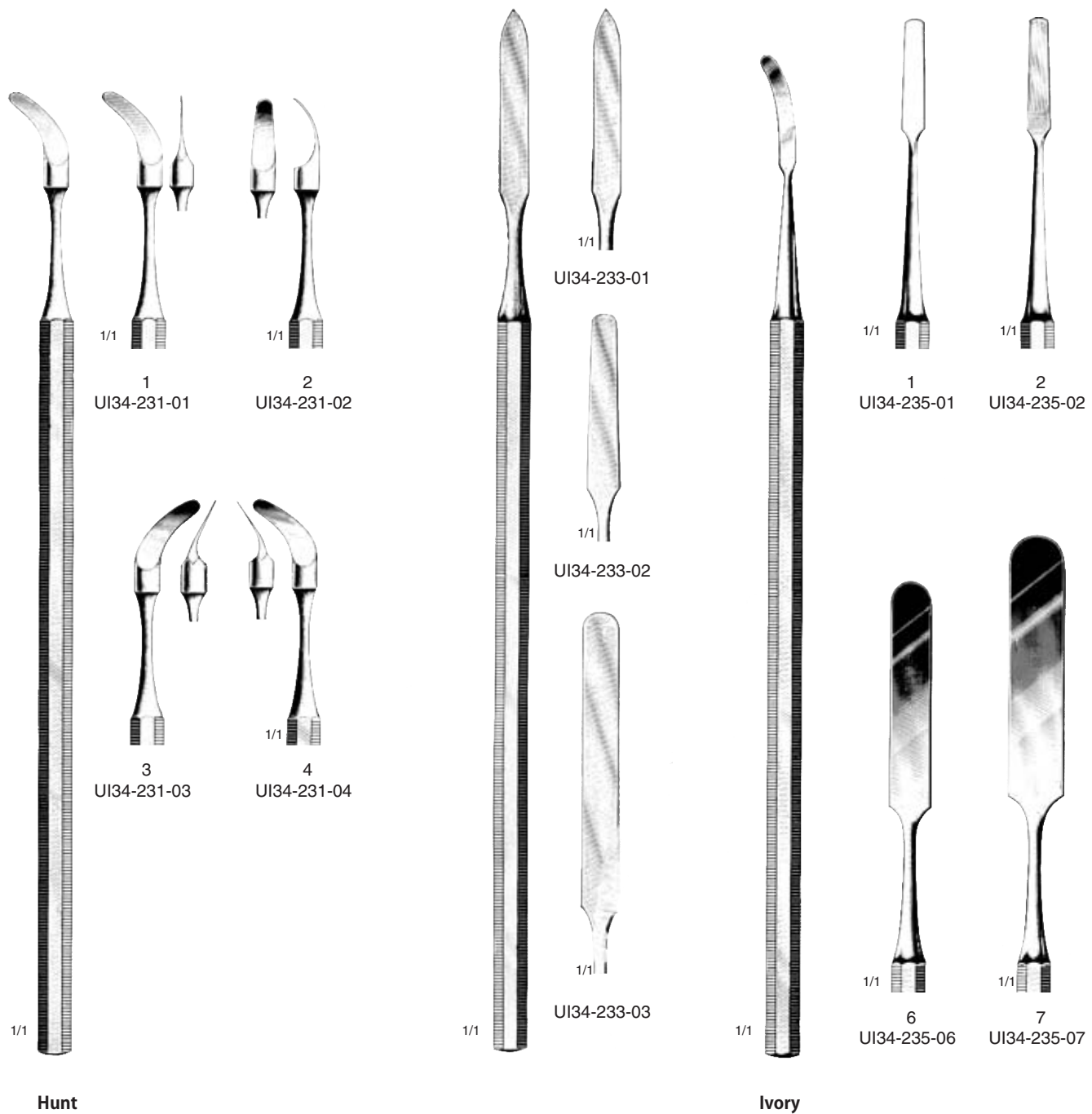
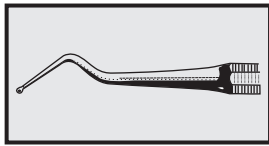

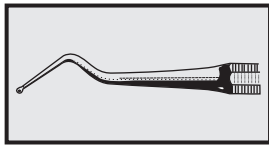

150 X 3 mm Ø
UI34-172-03



130 X 2 mm Ø UI34-237-02
185 x 2 mm Ø UI34-239-02
210 x 2 mm Ø UI34-241-02



UI34-243-02
UI34-245-02
UI34-247-02



100 X 2 mm Ø UI34-249-02
130 x 2 mm Ø UI34-251-02
150 x 2 mm Ø UI34-253-02



UI34-255-02
UI34-257-02
UI34-259-02



150 X 3 mm Ø UI34-261-03
185 x 3 mm Ø UI34-263-03
210 x 3 mm Ø UI34-265-03



130 X 4 mm Ø UI34-267-04
155 x 4 mm Ø UI34-269-04



17.5 cm / 7"
UI34-207-17

19 cm / 7½" UI34-271-19
22 cm / 8¼" UI34-273-22
25 cm / 10" UI34-275-25
28 cm / 11" UI34-277-28
30 cm / 12" UI34-279-30
35 cm / 14" UI34-281-35



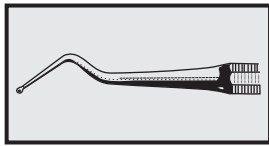

1/1

Didner
UI34-283-01



1/1

Ivory
UI34-285-01

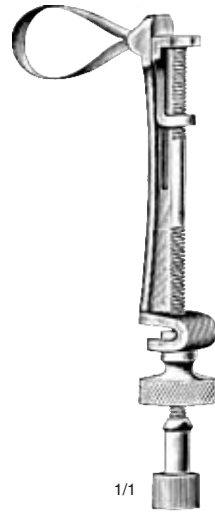

1/1

Ivory
UI34-287-01



1/1

Ivory
UI34-289-01



UI34-291-20 = 20 mm Ø
UI34-291-25 = 25 mm Ø
UI34-291-30 = 30 mm Ø



1/1

Ivory
UI34-293-01



1/1

Ivory
UI34-295-01



1/1

Ivory
UI34-297-01

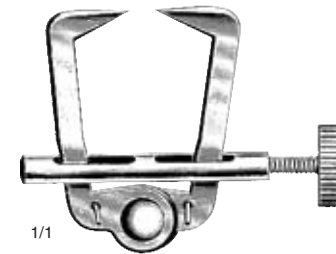

1/1

Elliot
UI34-299-01

UI34-283-01	UI34-289-01	Matrix Retainer
UI34-291-20	UI34-291-30	Rubber-dam Holder
UI34-293-01	UI34-295-01	Matrix Retainer
UI34-297-01	UI34-299-01	Separators

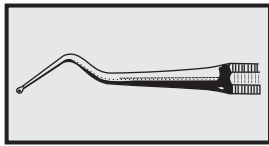

17 cm / 6¾"

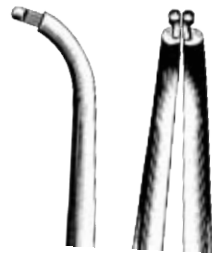

UI34-301-17



UI34-303-17

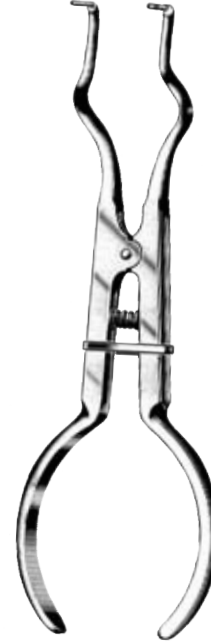

Brewer
17 cm / 6¾"
UI34-305-17



Ivory
17 cm / 6¾"
UI34-307-17

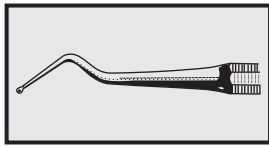

UI34-309-01



UI34-309-02



UI34-309-03



UI34-309-04



UI34-309-05



UI34-309-06

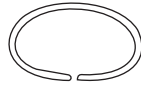

UI34-309-07



UI34-309-08

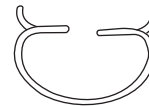

UI34-311-01



UI34-311-02



UI34-311-03



UI34-311-04



UI34-311-05



UI34-311-06



UI34-311-07

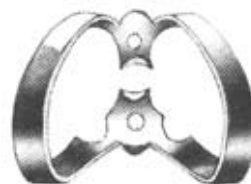

UI34-311-08



UI34-311-09

UI34-309-01	UI34-309-05	Molar Clamps
UI34-309-06	UI34-309-08	Bicuspid Clamps
UI34-311-01	UI34-311-06	Molar Clamps
UI34-311-07	UI34-311-09	Labial Clamps

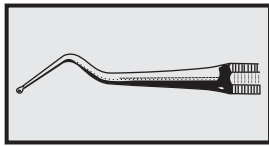

UI34-313-10



UI34-313-11



UI34-313-12



UI34-313-13



UI34-313-14



UI34-313-15



UI34-313-16



UI34-313-17

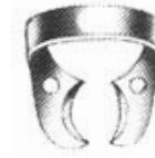

UI34-313-18



UI34-313-19



UI34-313-20



UI34-313-21



UI34-313-22



UI34-313-23



UI34-313-24



UI34-313-25



UI34-313-26



UI34-313-27

UI34-313-10	UI34-313-14	Molar Clamps
UI34-313-15	UI34-313-20	Molar Clamps
UI34-313-21	UI34-313-27	Bicuspid Clamps

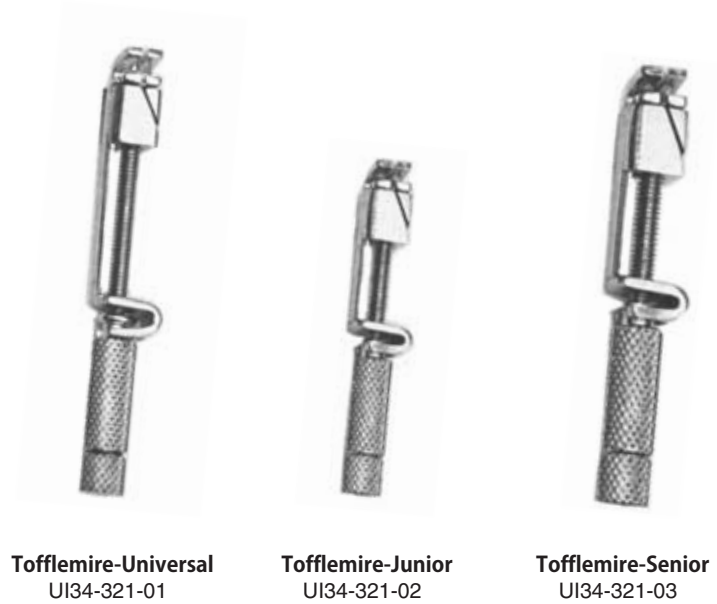
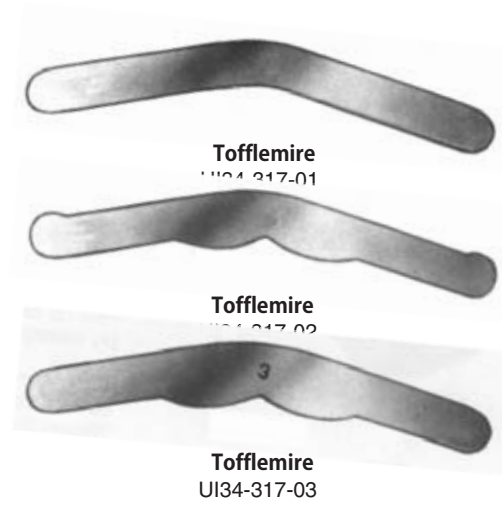
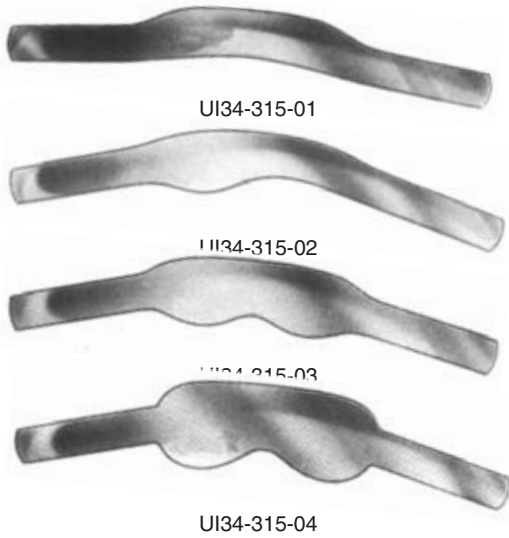
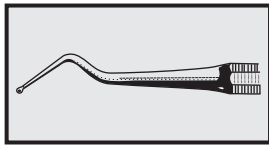

UI34-315-01	UI34-319-03	Matrix Bands
UI34-321-01	UI34-321-03	Matrix Retainer

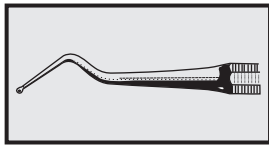

Periodontosis Instruments

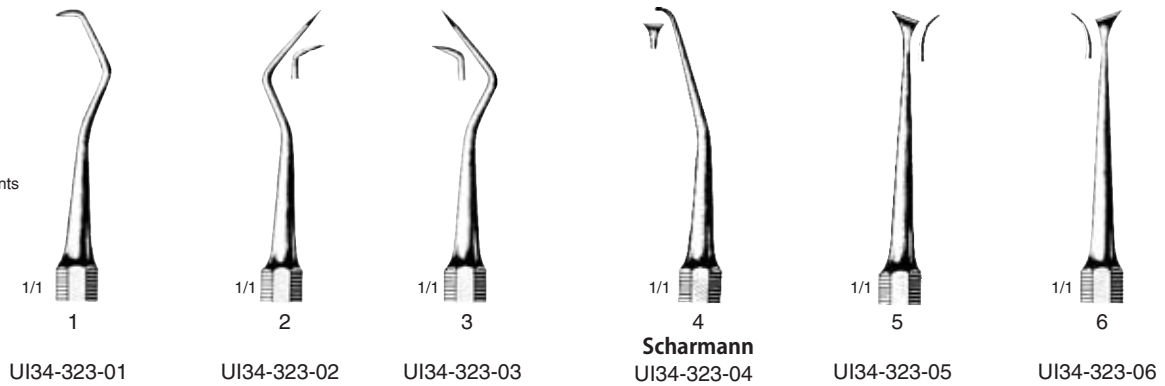

Periodontosis Instruments



Periodontosis Instruments

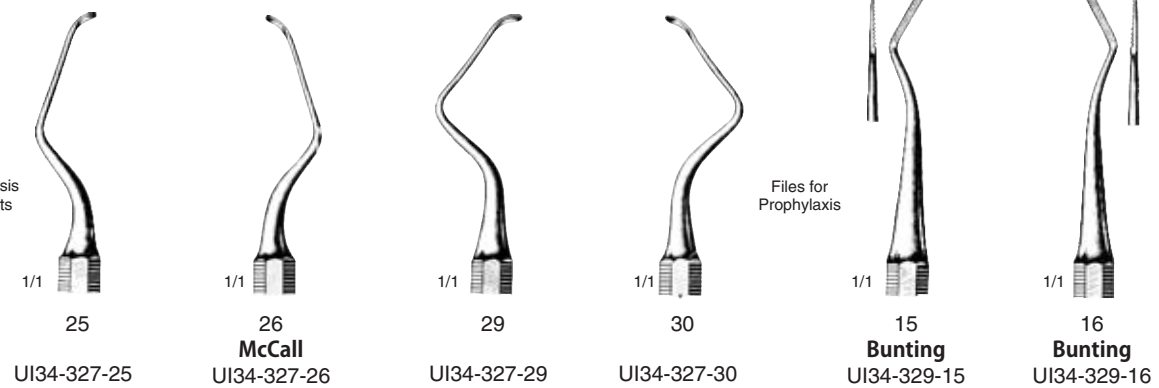

Files for Prophylaxis

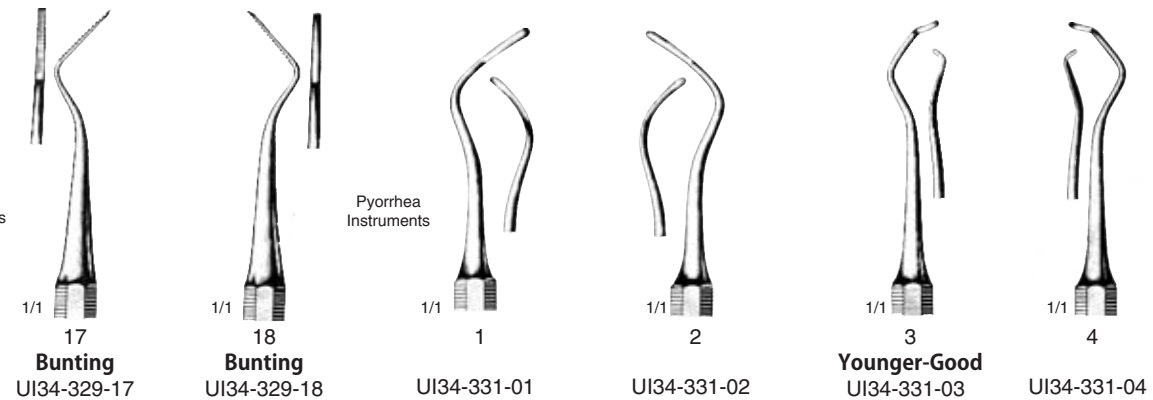

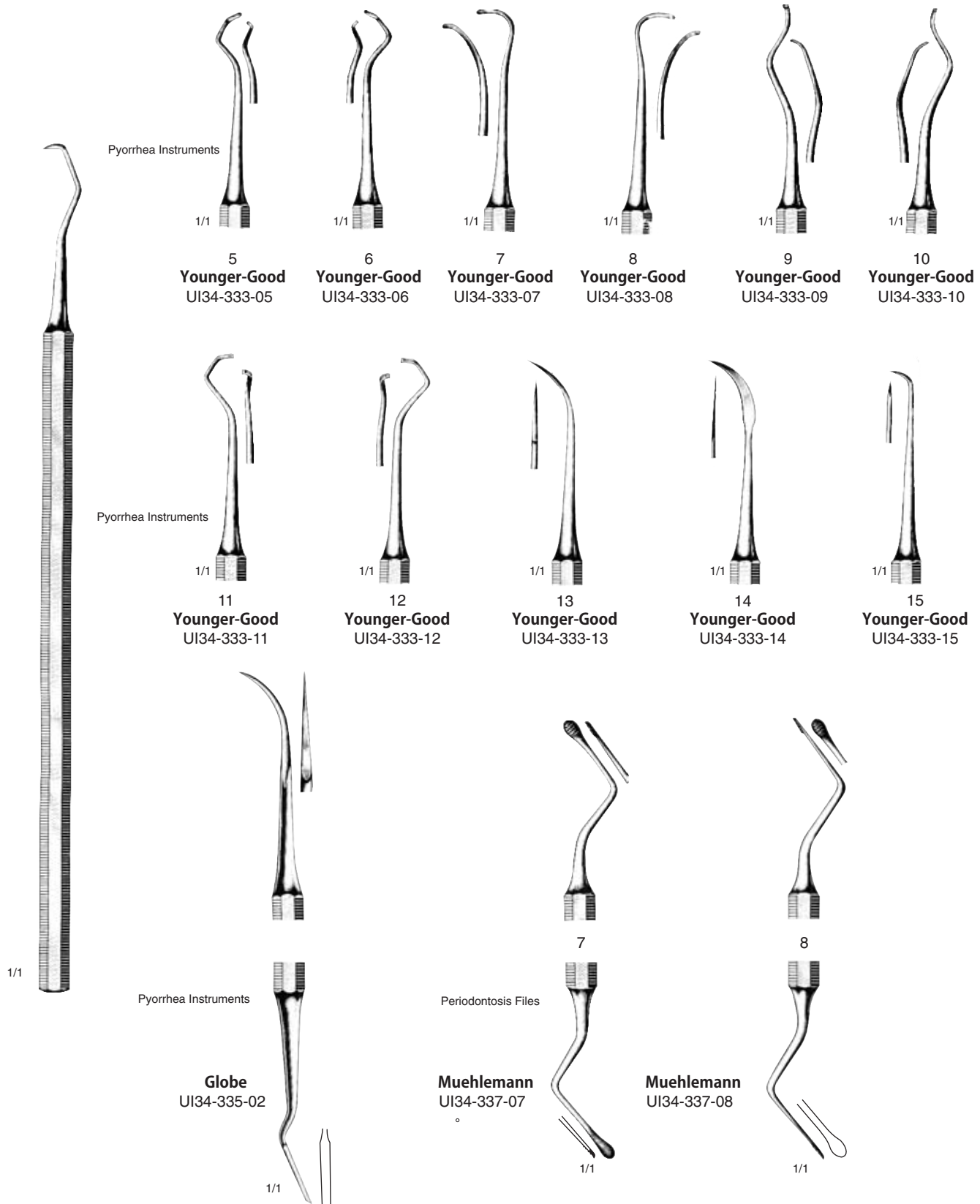
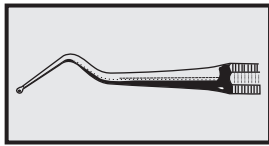

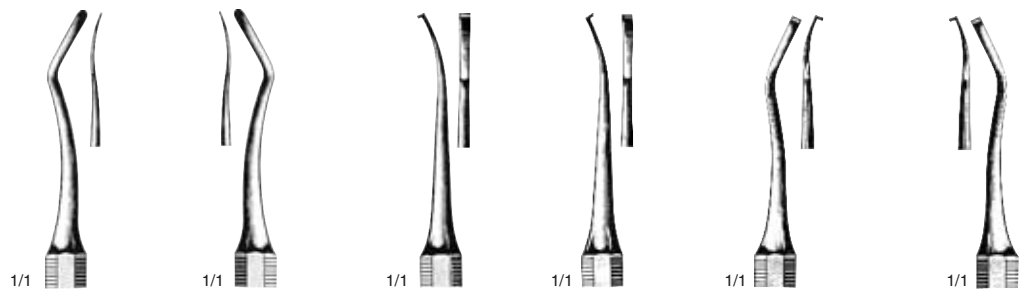
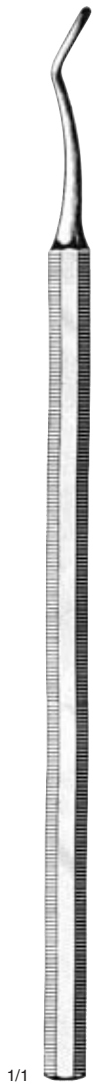
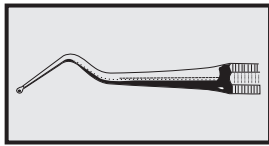

Black					
1	2	3	4	5	6
UI34-339-01	UI34-339-02	UI34-339-03	UI34-339-04	UI34-339-05	UI34-339-06
15	15	15	15	15	15
8	8	F	B	8	8
6	6			6	6
L	R			L	R

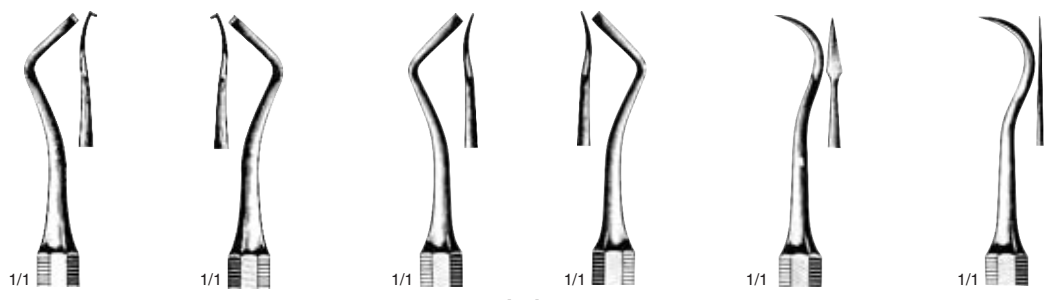

Black					
7	8	9	10	11	12
UI34-339-07	UI34-339-08	UI34-339-09	UI34-339-10	UI34-339-11	UI34-339-12
15	15	15	15	25	20
8	8	8	8		
6	12	12	12		
R	R	L	R		

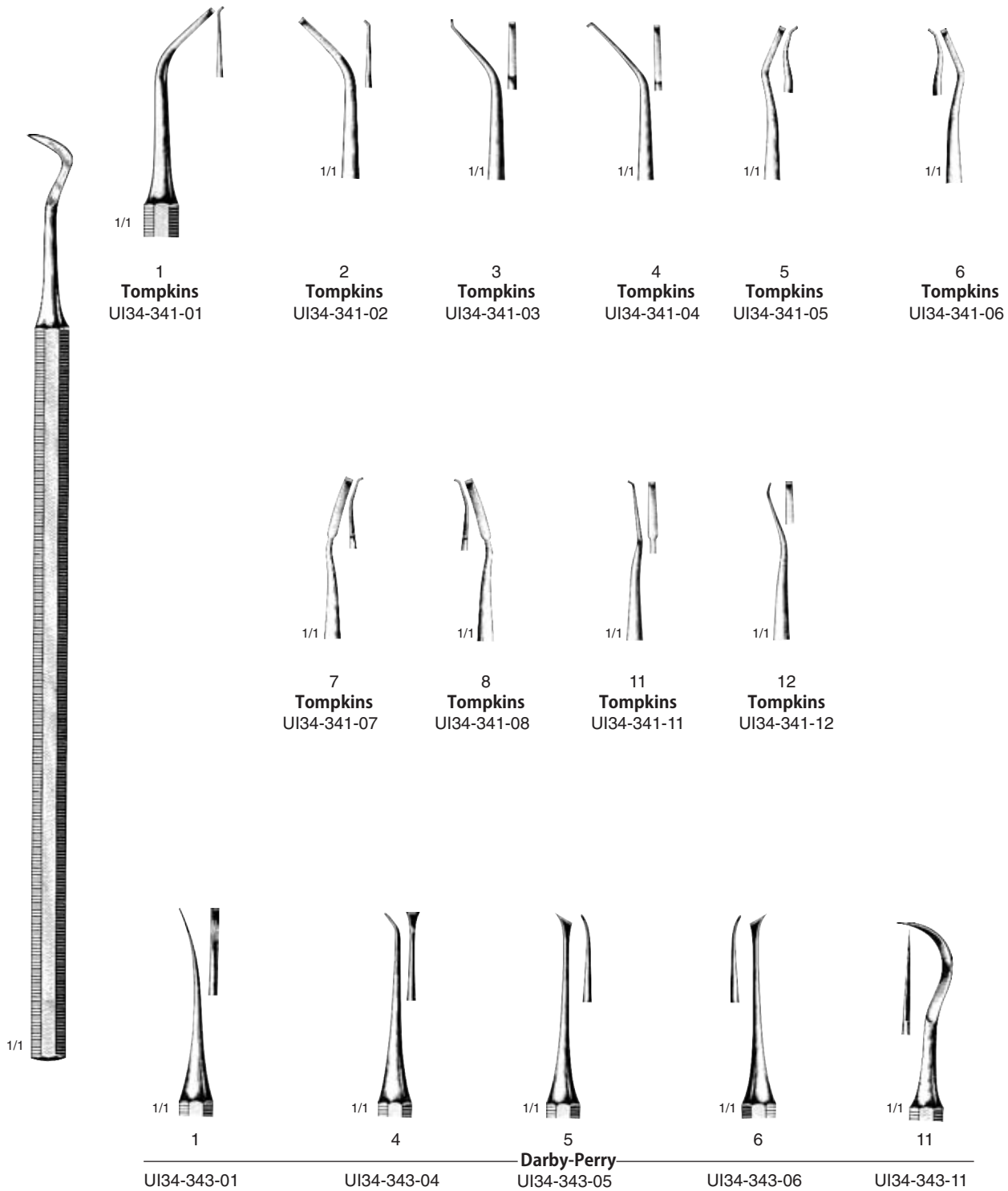
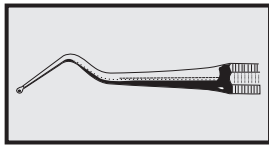

UI34-341-01 UI34-343-11 Pyorrhea Instruments

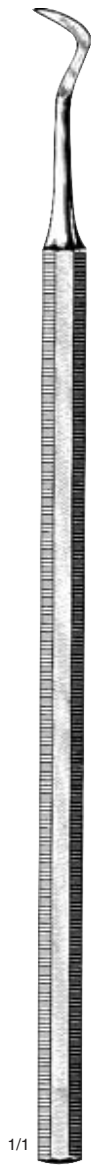
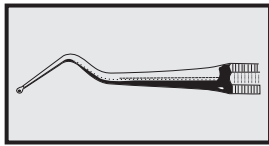

15
Cleveland
UI34-344-15



12B
UI34-345-12



1
UI34-345-01



2
UI34-345-02



3
UI34-345-03

White



13Z
Zerfing
UI34-347-13



Whiten
UI34-349-01



01
Moore
UI34-351-01



02
Moore
UI34-351-02



1
UI34-353-01



2
Jaquette
UI34-353-02



3
UI34-353-03

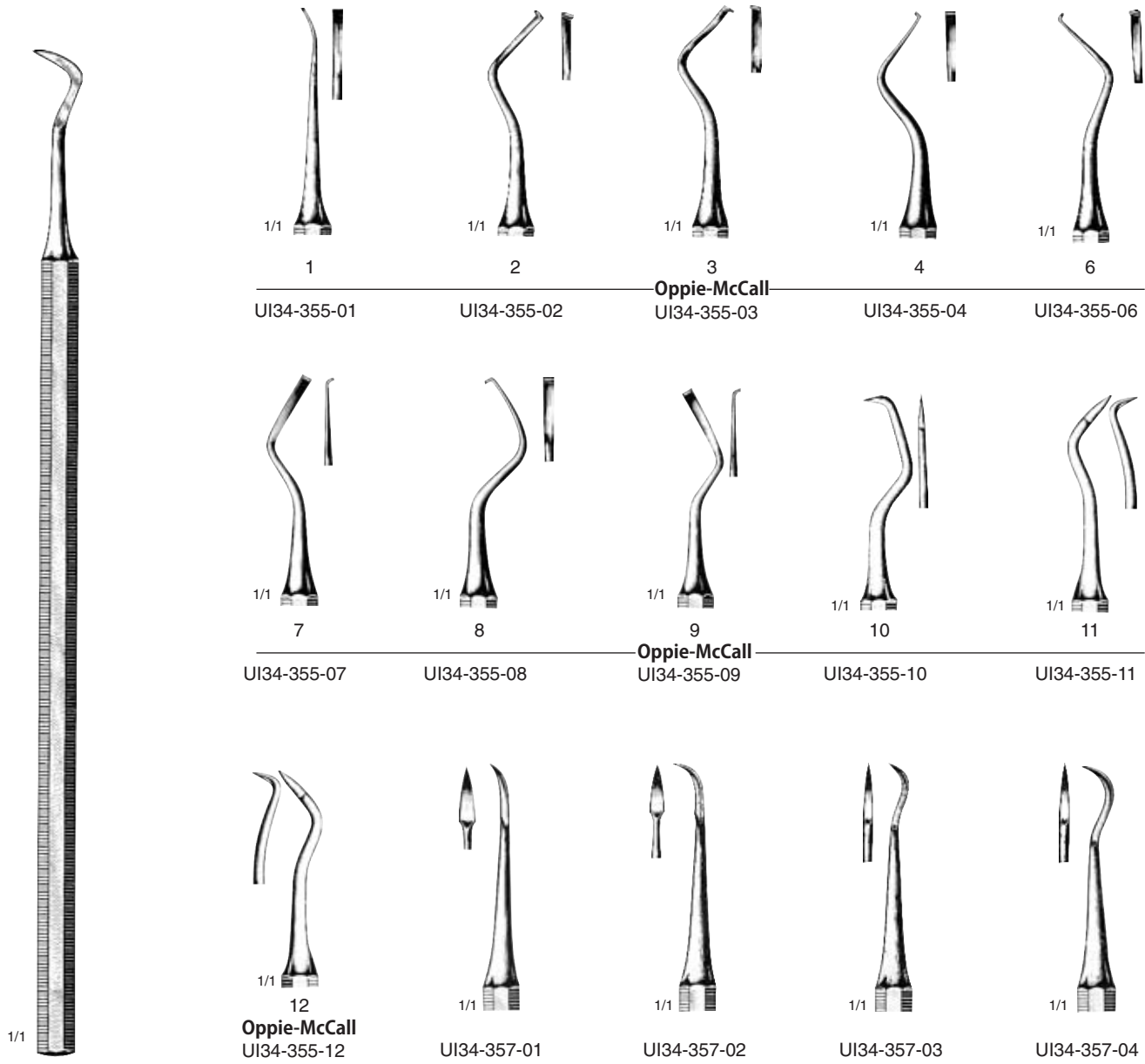
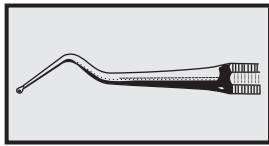

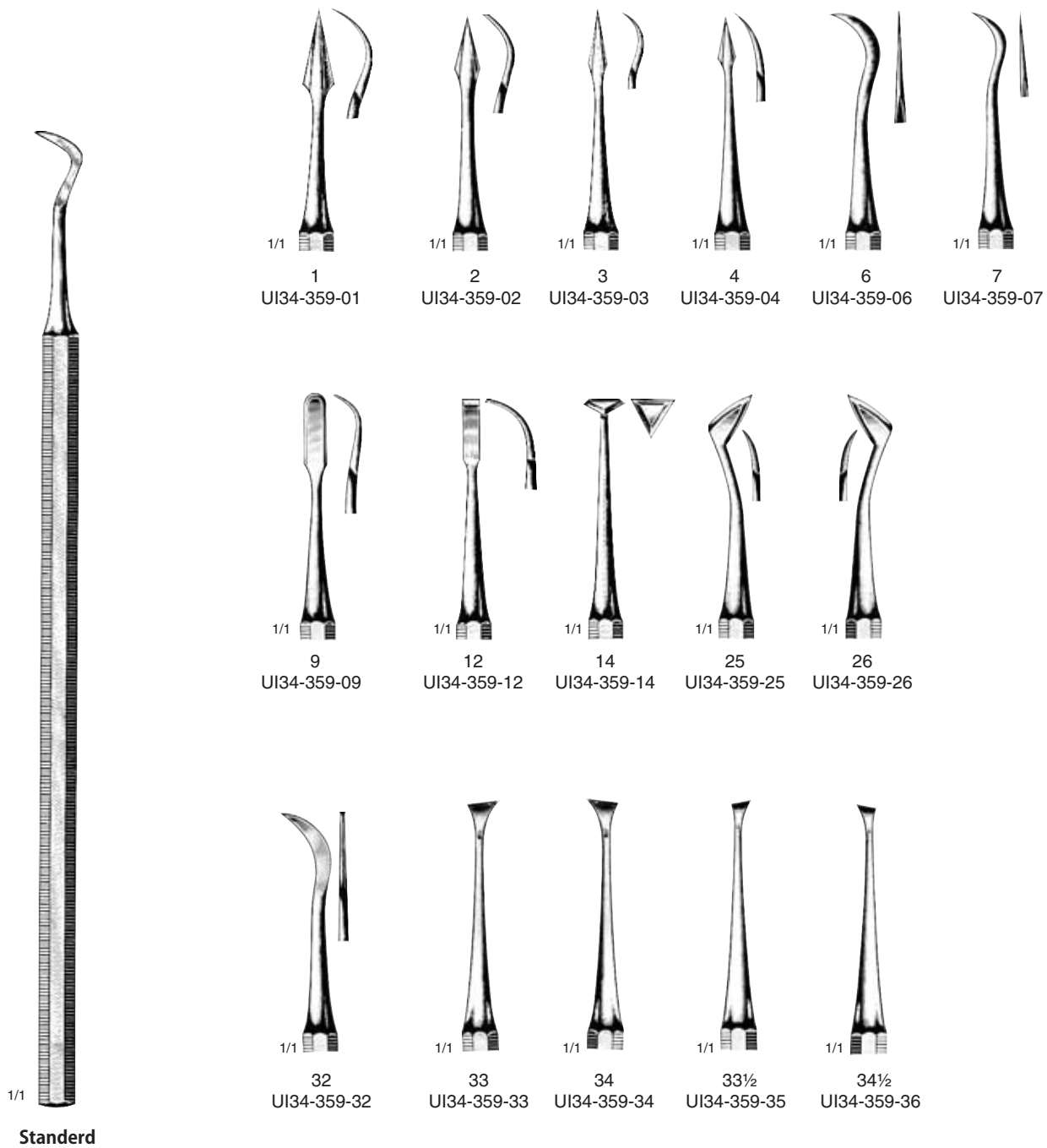
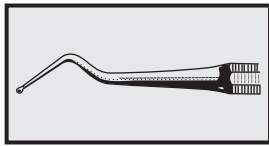

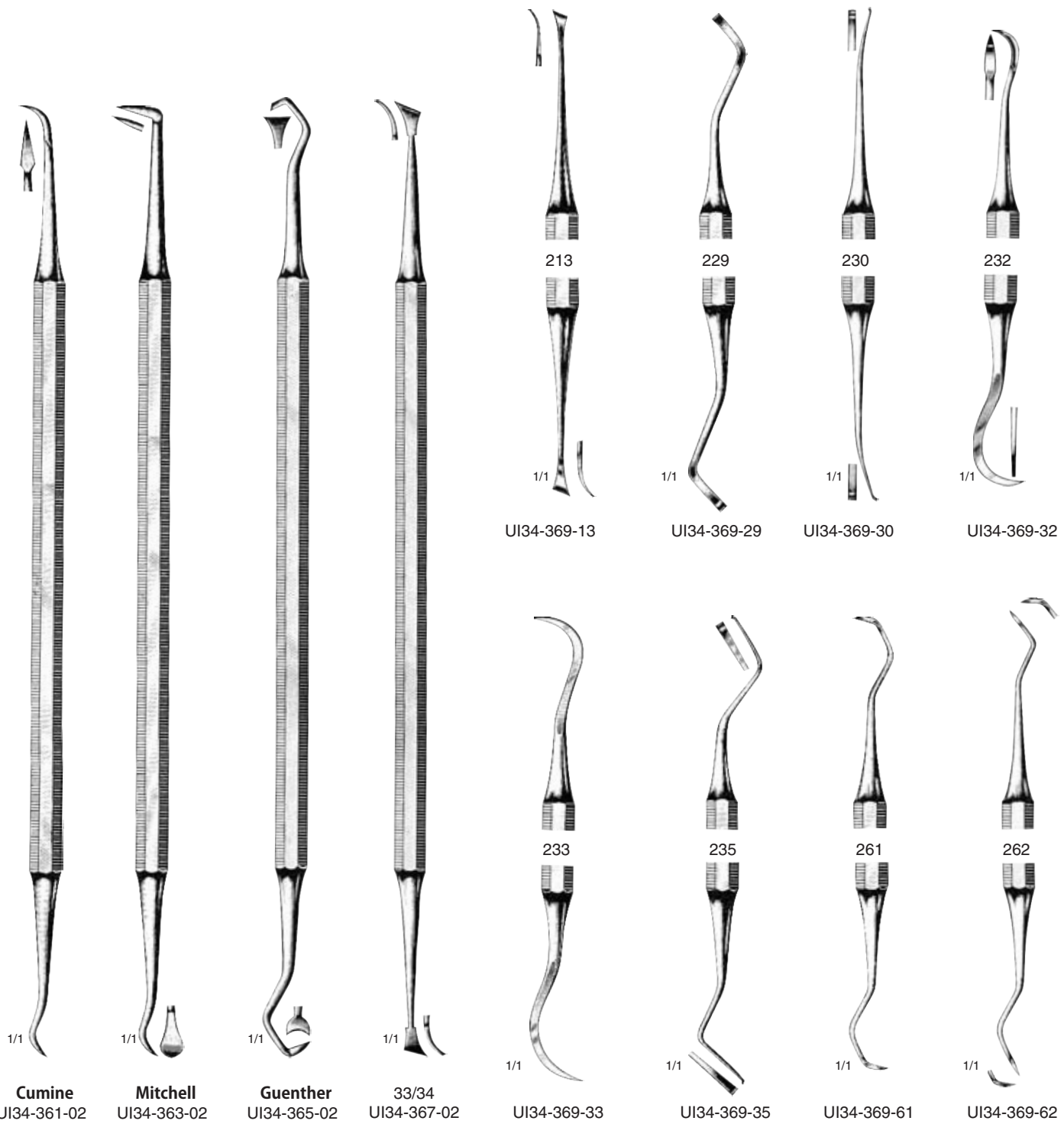
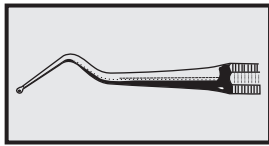

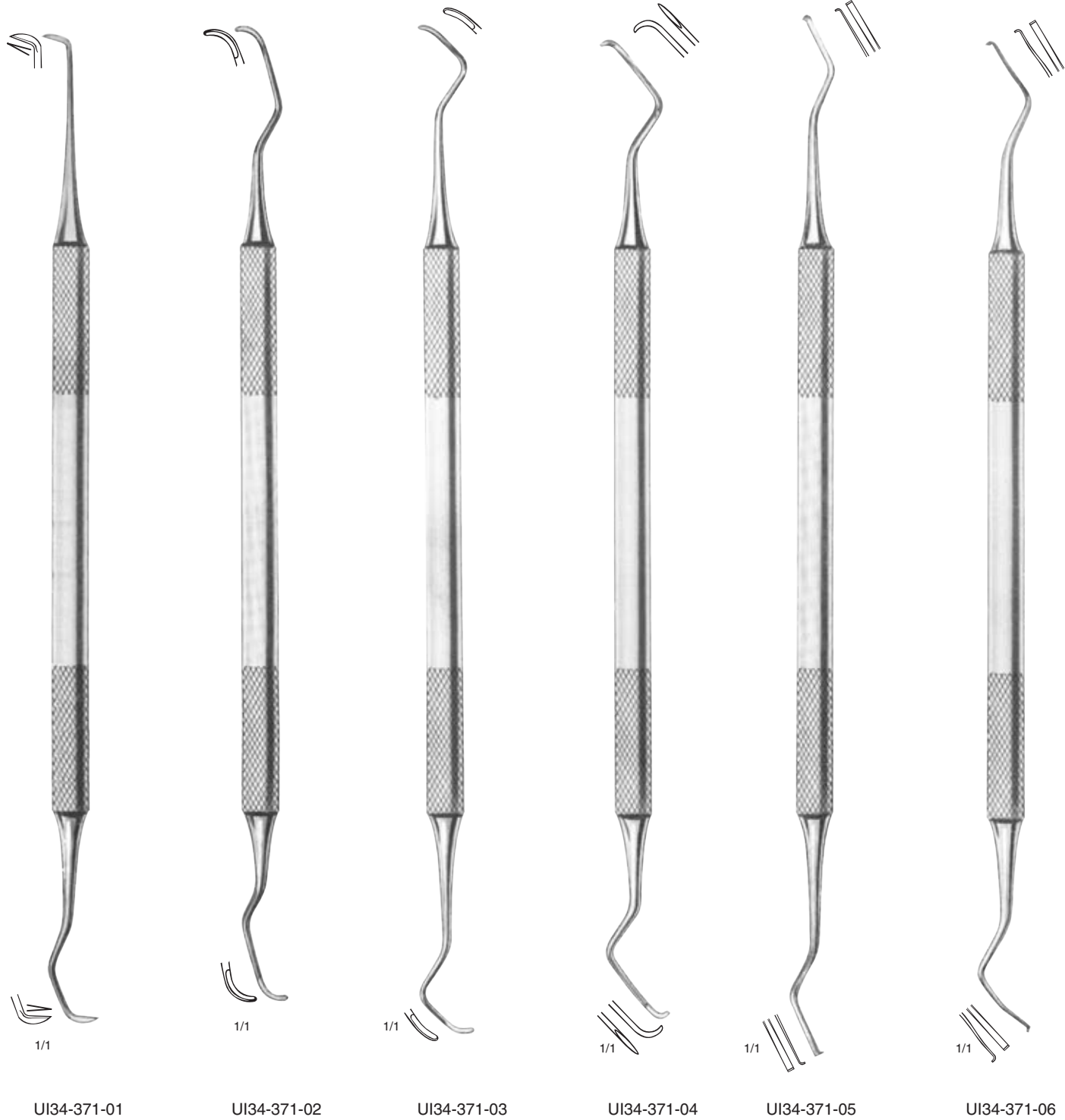
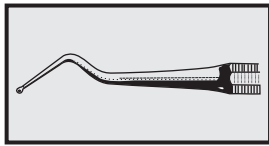

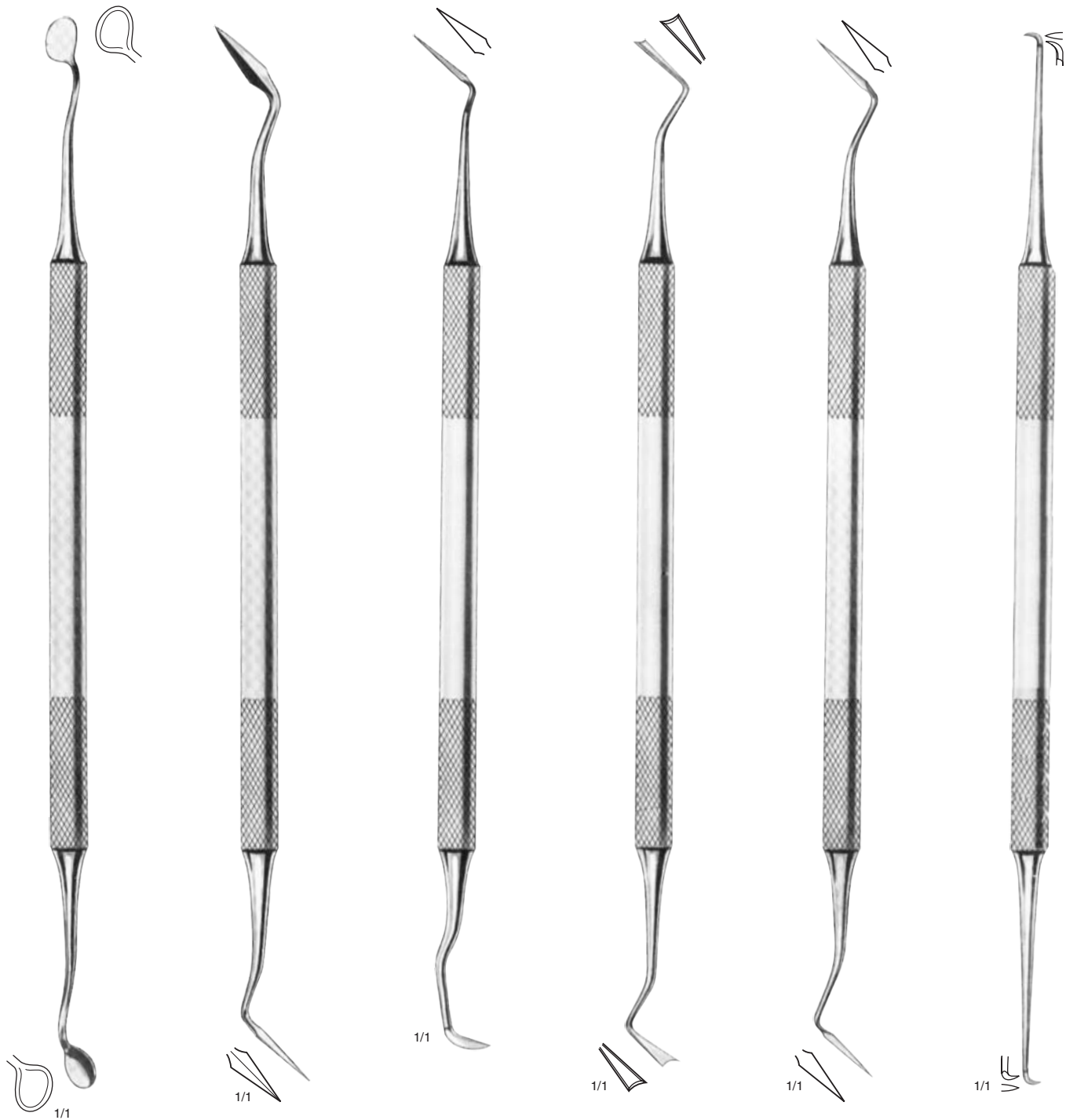
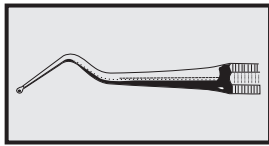

UI34-371-07

UI34-371-08

UI34-371-09

UI34-371-10

UI34-371-11

UI34-371-12

UI34-371-07	UI34-371-11	Gingivectomy Knives
	UI34-371-12	Scaler, double-ended

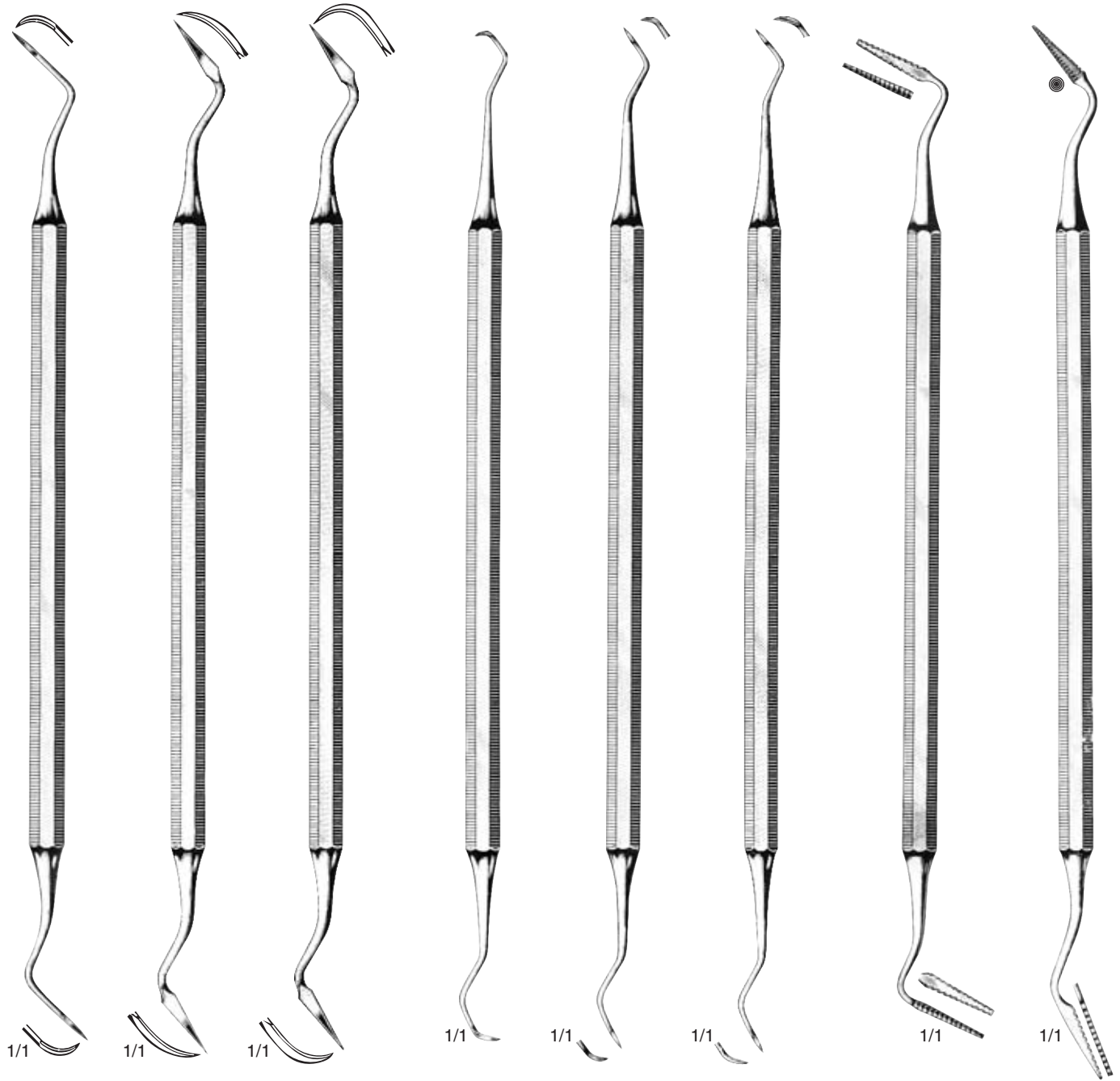
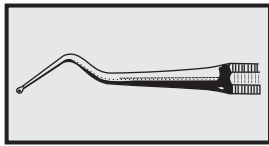

UI34-373-01

UI34-373-02

UI34-373-03

UI34-375-01

Jaquette
UI34-375-02

UI34-375-03

Buck
UI34-377-01

Sanders
UI34-379-01

UI34-373-01	UI34-375-03	Scalers double-ended
UI34-377-01	UI34-379-01	Interproximal Trimmers

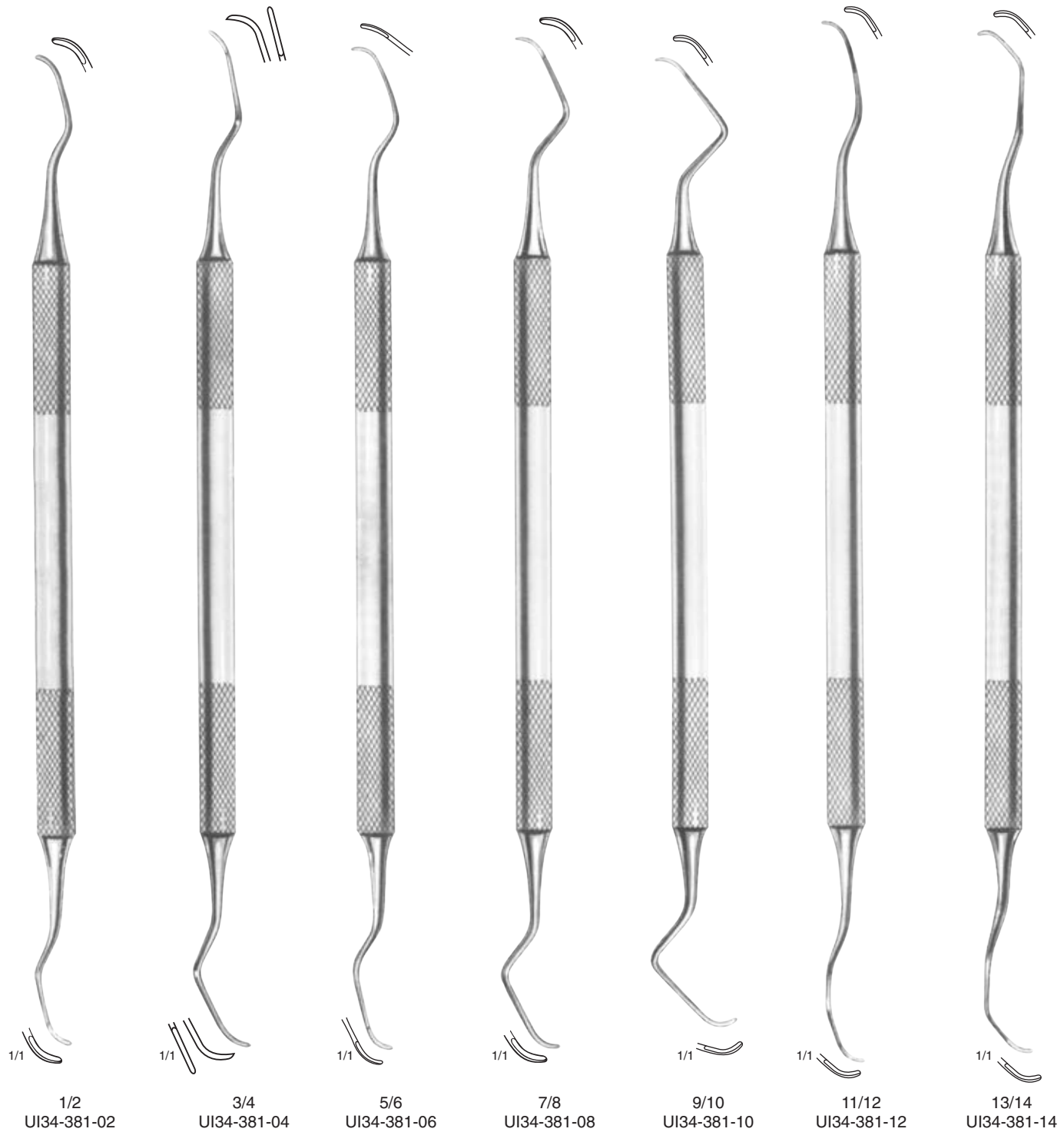
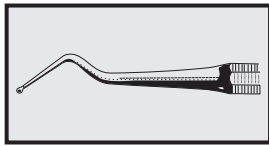

UI34-381-02 UI34-381-14 Scalers

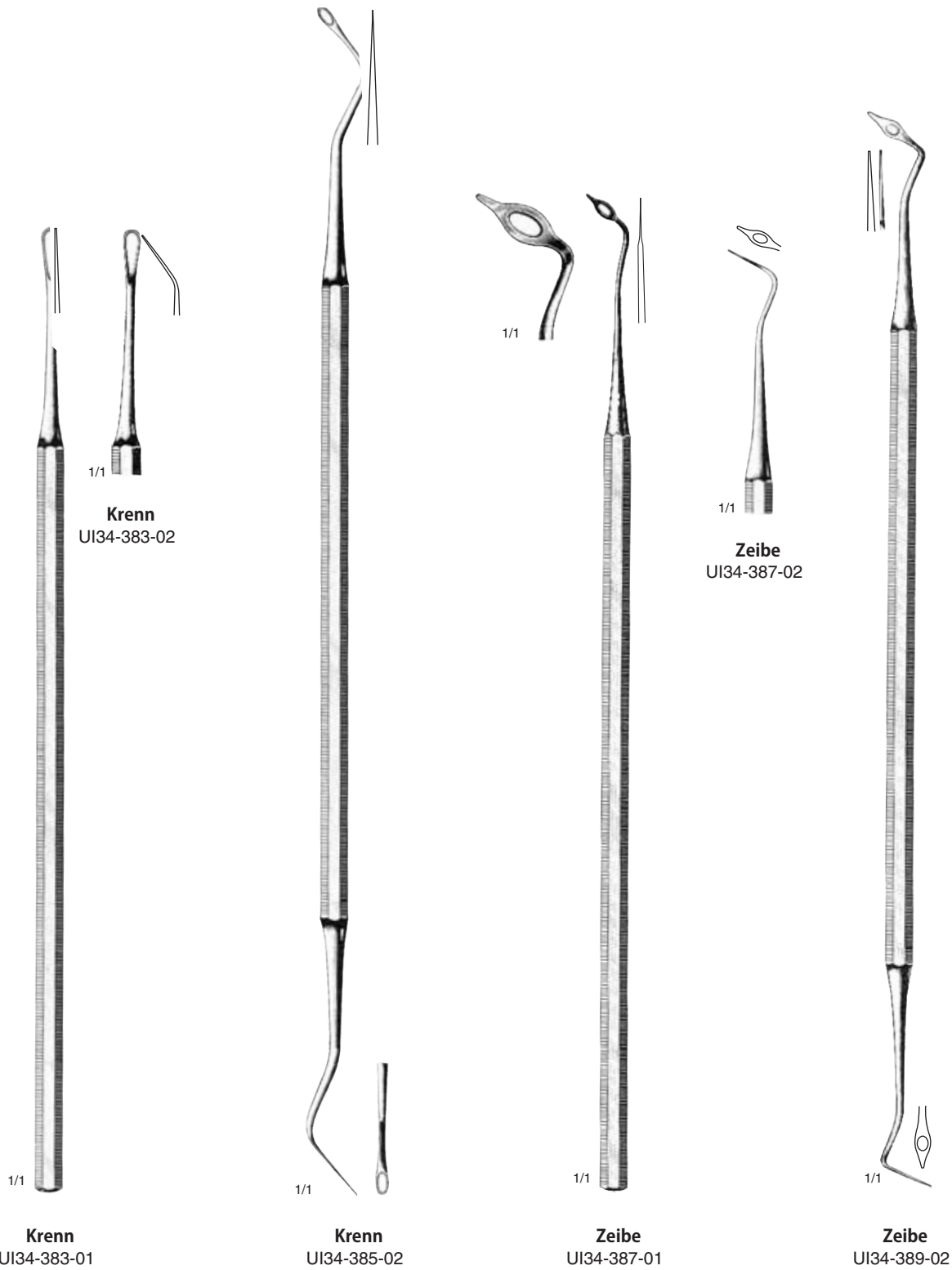
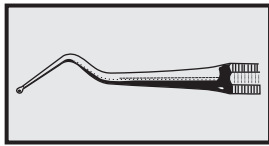

UI34-383-01	UI34-385-02	Loops
UI34-387-01	UI34-389-02	Gum Probes with Eye

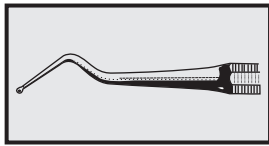

Crane-Kaplan
UI27-173-30

Crane-Kaplan
UI27-175-30

UI34-393-01

UI34-395-01

UI34-395-02

Krenn
UI34-397-02

UI27-173-30	UI27-175-30	Pocket markers
UI34-393-01	UI34-397-02	Probes for measuring gum pockets

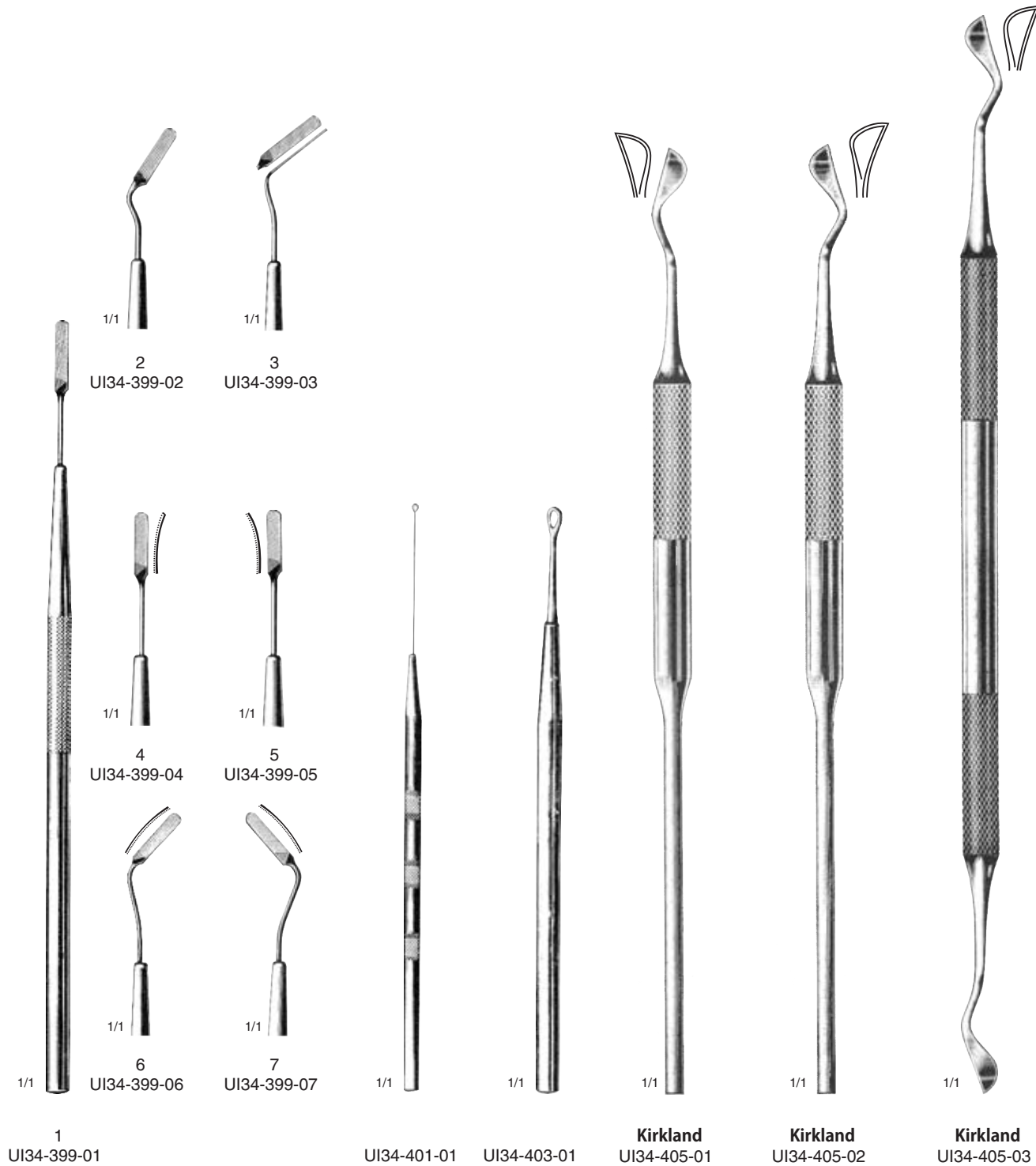
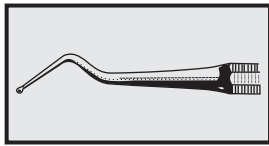

UI34-399-01	UI34-399-07	Finishing Files
UI34-401-01	UI34-403-01	Loops
UI34-405-01	UI34-405-03	Gingivectomy Knives

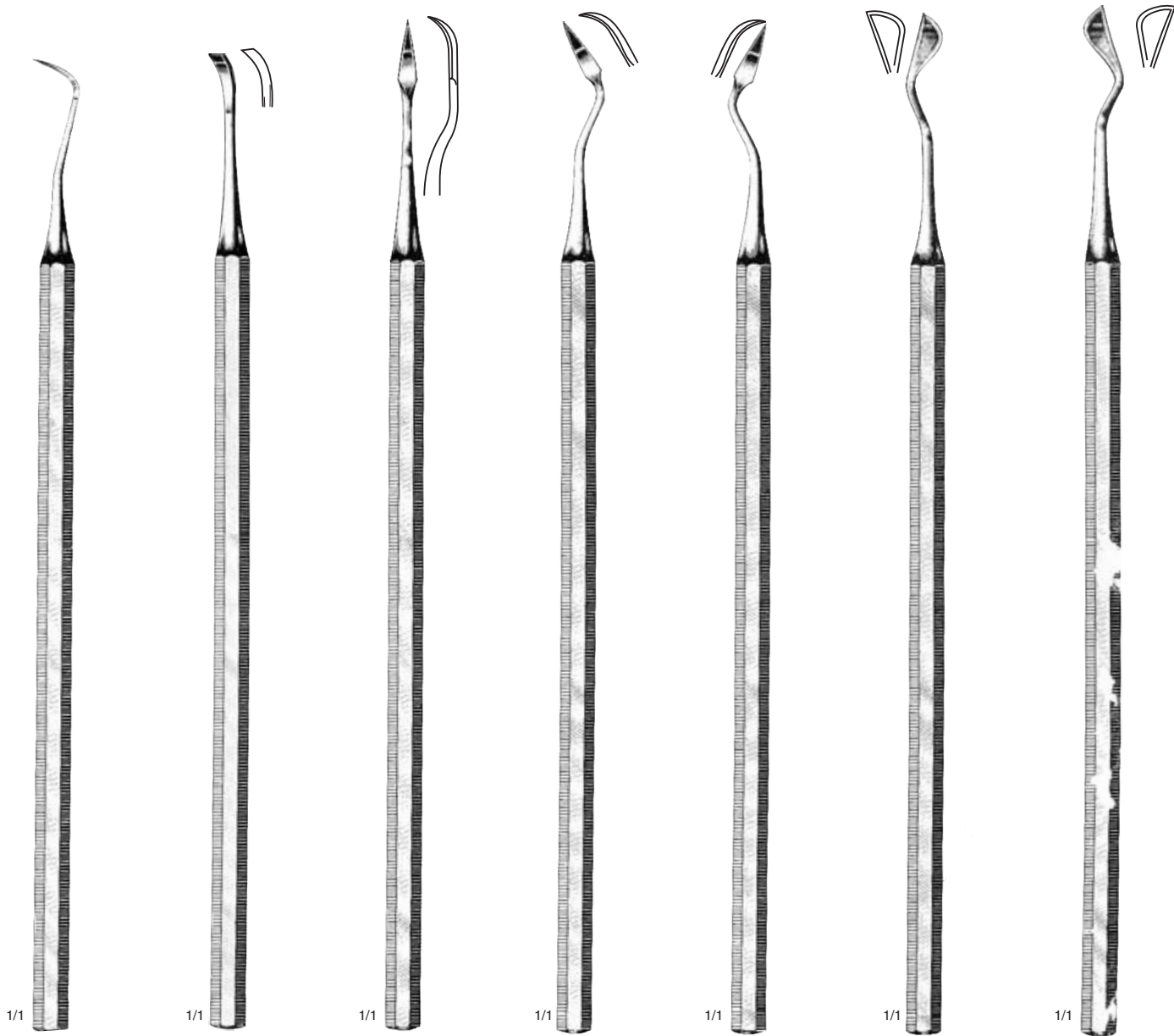
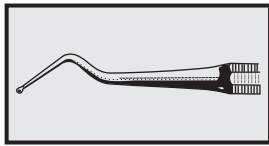

Mercitan

UI34-407-01

UI34-407-02

Ward-Kirkland

UI34-409-01

UI34-409-02

UI34-409-03

UI34-409-04

UI34-409-05

UI34-407-01 UI34-409-05 Scalers, Single-ended

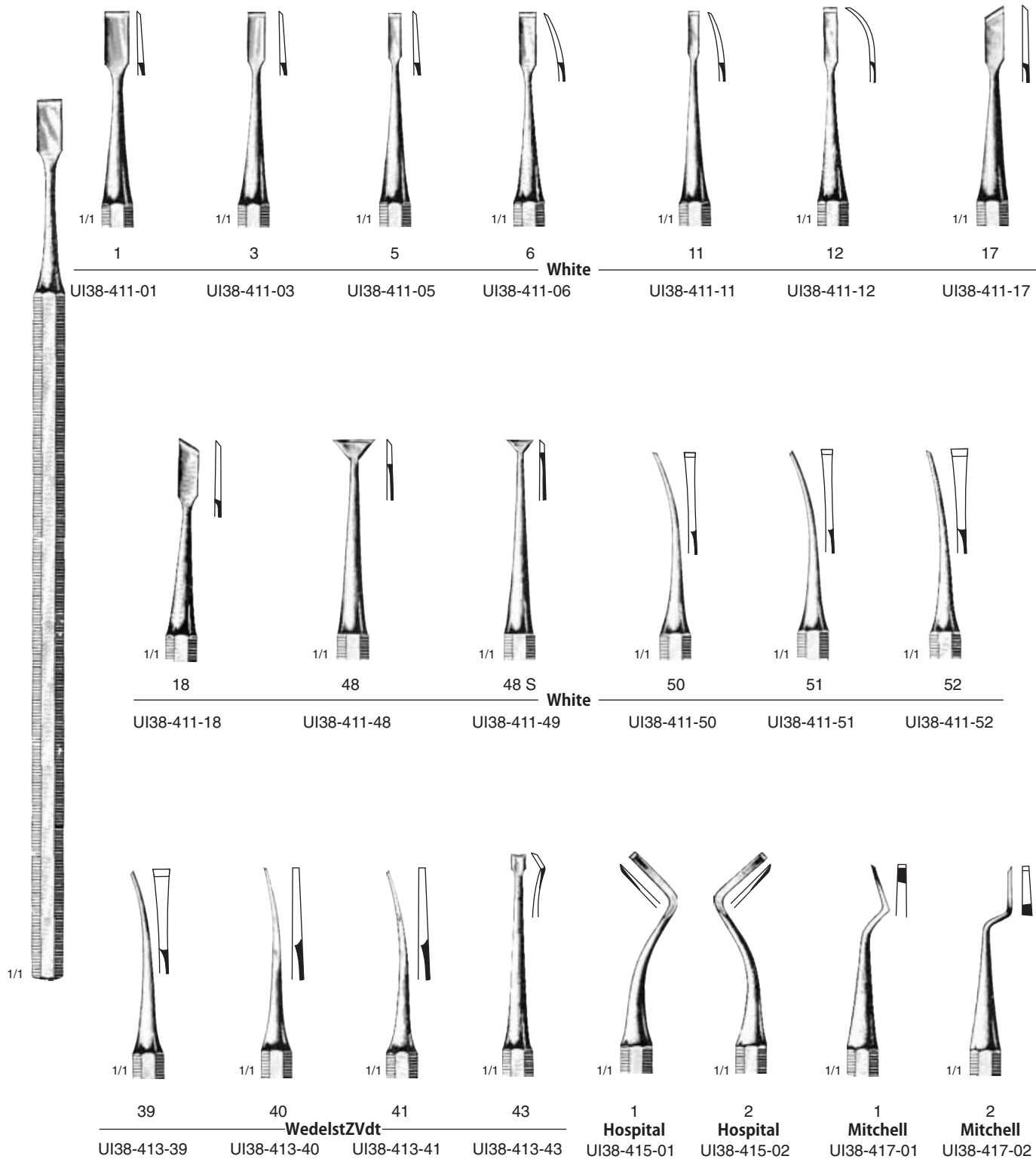
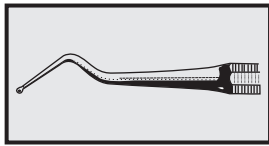

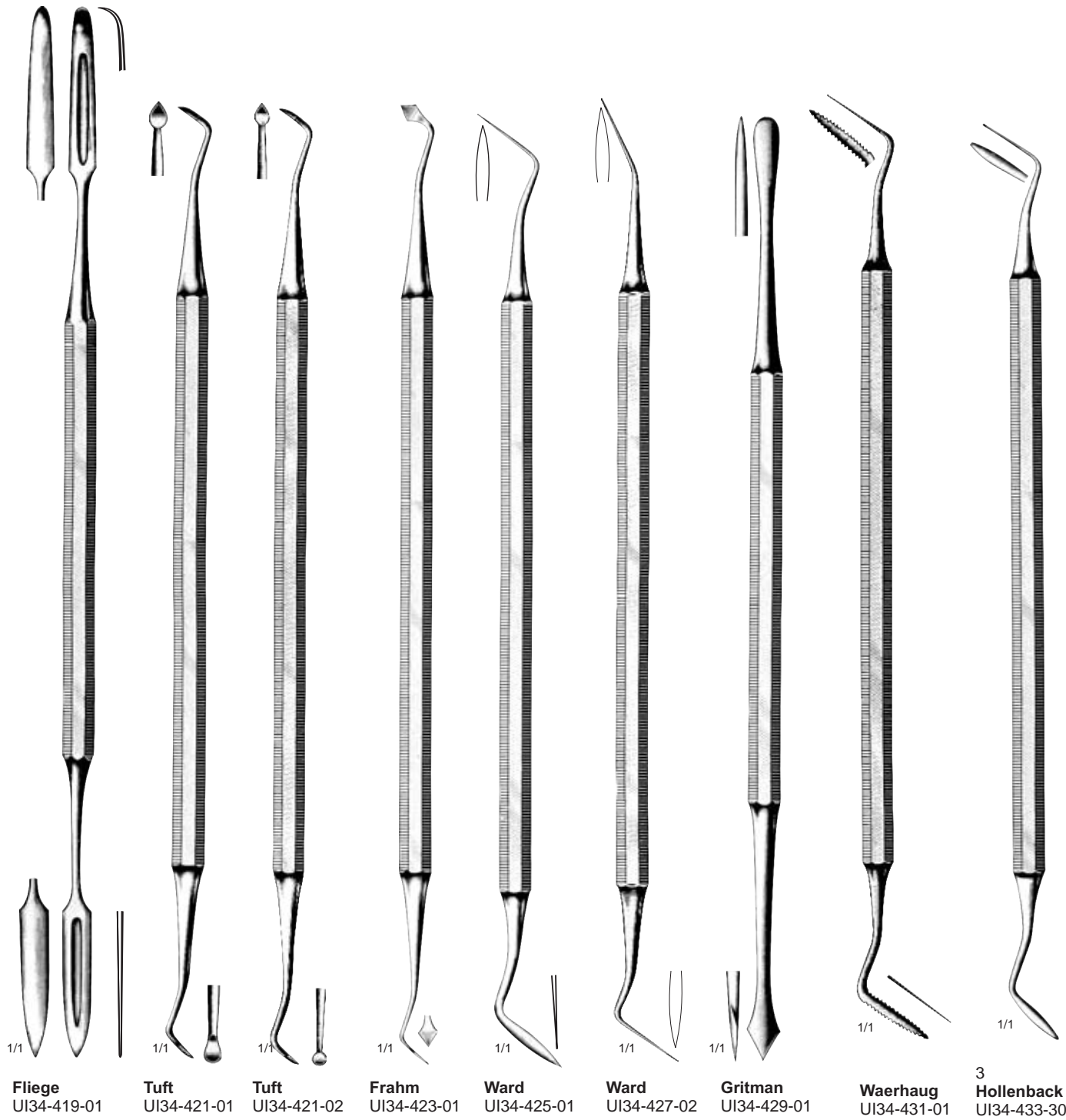
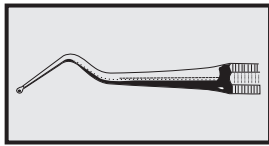

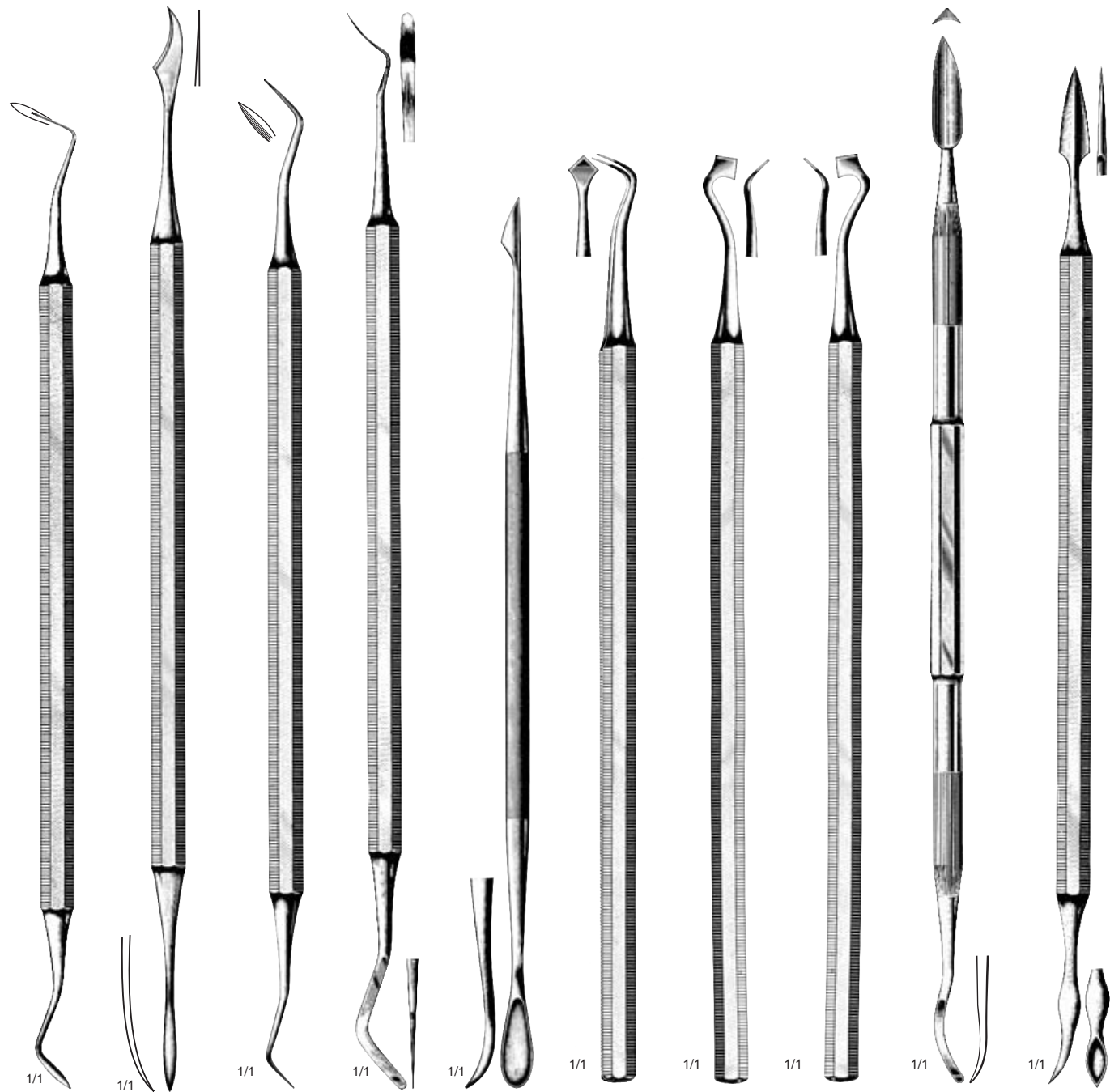
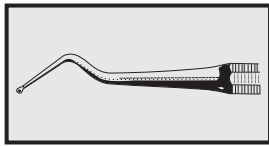

3S
Hollenback
UI34-435-31

No. 5
UI34-437-01

Shooshan
UI34-439-01 UI34-441-01 UI34-443-01

1
Frahm
UI34-445-01

2
Frahm
UI34-445-02

3
Frahm
UI34-445-03

Roach
UI34-447-01 UI34-449-01

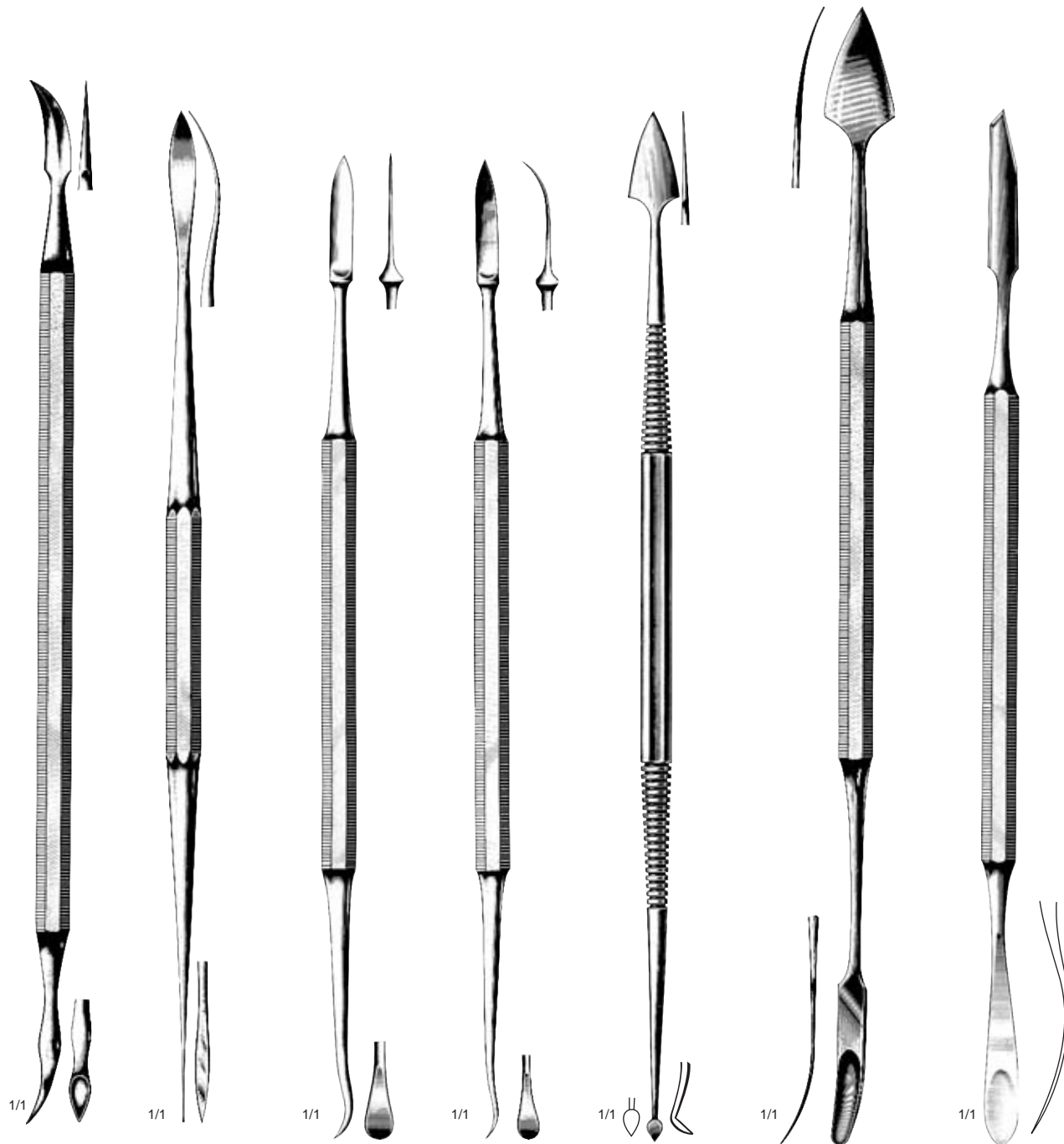
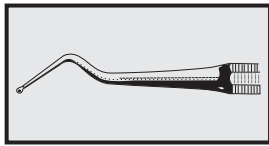

Roach
UI34-451-02

Riegner
UI34-453-01

Evans
UI34-455-01

Evans
UI34-457-01

Vehe
UI34-459-01

Wolff
UI34-461-01

Fjeldstad
UI34-463-01

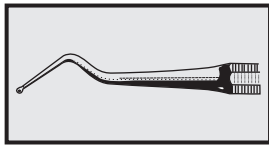

Acker
UI34-465-01

Falck
UI34-467-01

Falck
UI34-469-01

Beale
UI34-471-01

Ermert
UI34-473-01

Ermert
UI34-475-01

Gisy-Wild
15 cm / 6"
UI34-477-15

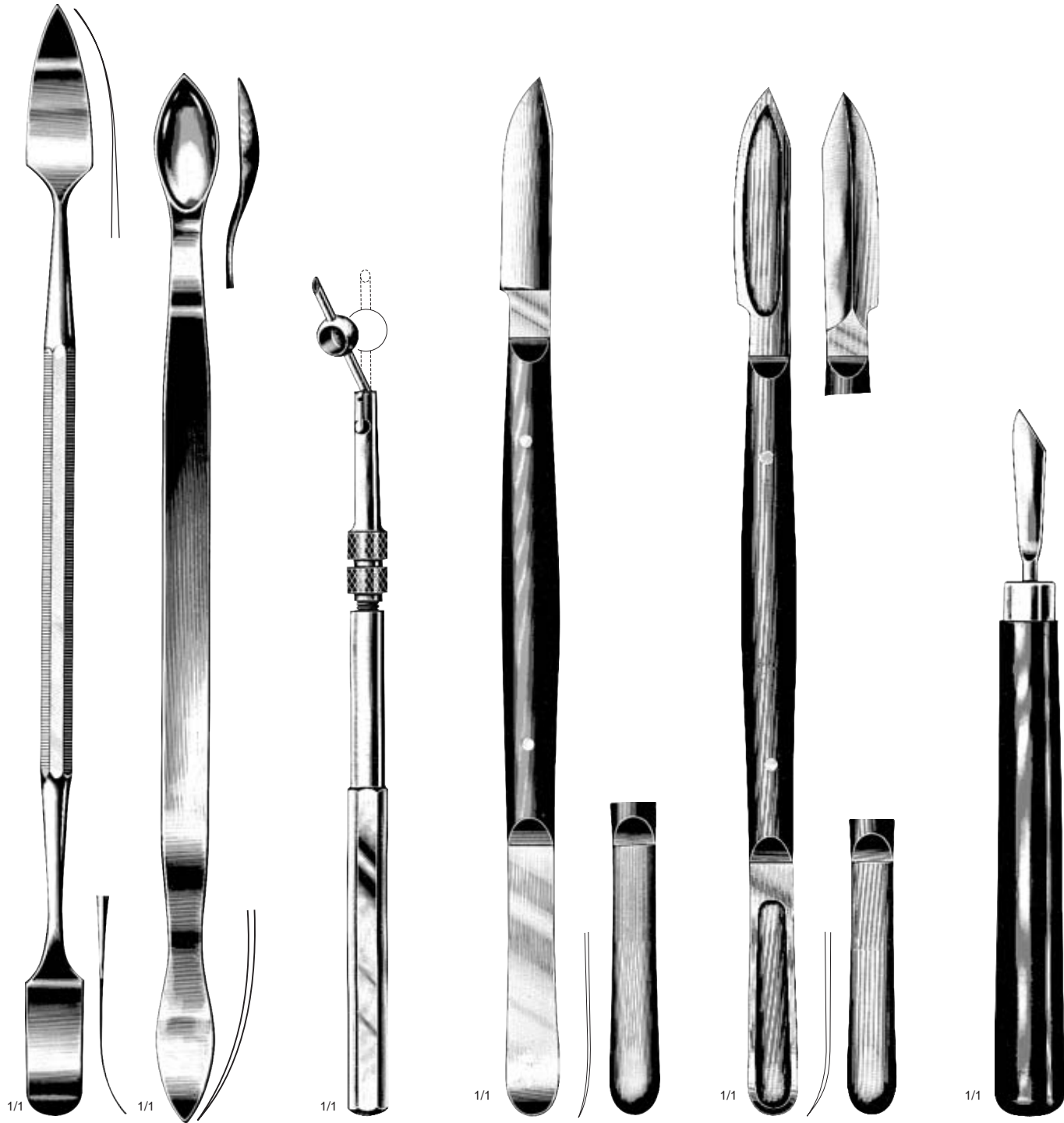
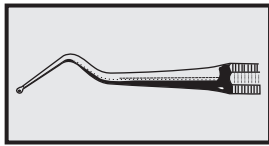

Gritman

UI34-479-01

1/1

UI34-481-01

Cerafix

UI34-483-01

Fahnenstock

13 cm / 5"
UI34-485-13

Fahnenstock

17 cm / 6 3/4"
UI34-485-17

Lessmann

13 cm / 5"
UI34-487-13

Lessmann

17 cm / 7"
UI34-487-17

Antkoviak

12.5 cm / 5"
UI34-489-12

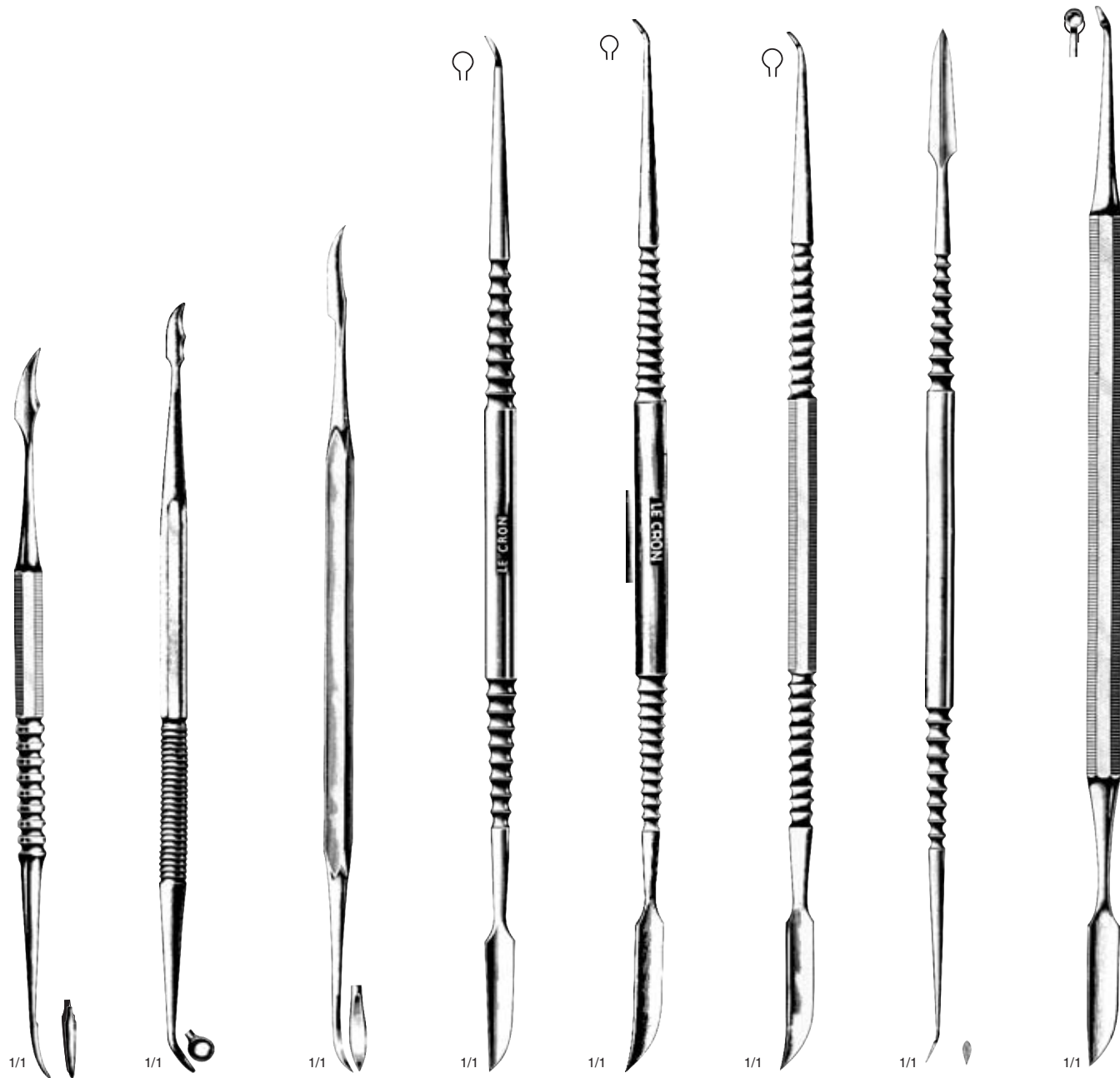
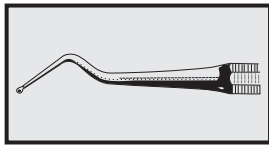

Zahle
UI34-491-01

Hylin
UI34-493-01

Zahle
UI34-495-01

Le Cron
UI34-497-01

Le Cron
UI34-499-01

Le Cron
UI34-501-01

Zahle
UI34-503-01

Zahle
UI34-505-01

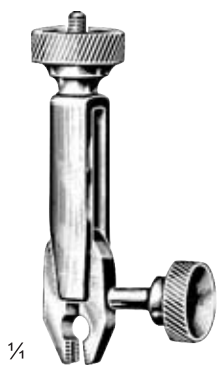
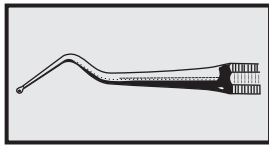

$\frac{1}{4}$
Ivory
UI34-510-01
Post Puller



Miller
UI34-517-15
15 cm/6"
Forceps for Articulating
Paper

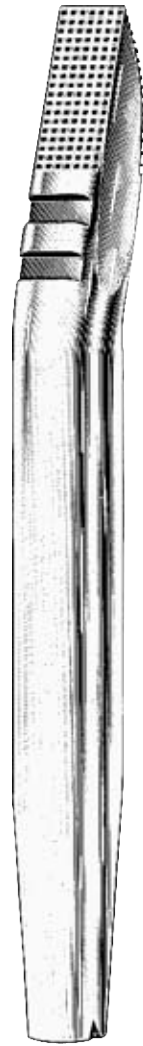

Sachs
UI34-520-01
Plexiglas

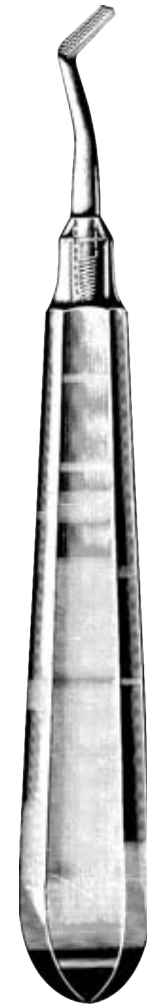

UI34-524-00



Fig. 1
UI34-525-01



Fig. 2
UI34-525-02



Fig. 3
UI34-525-03

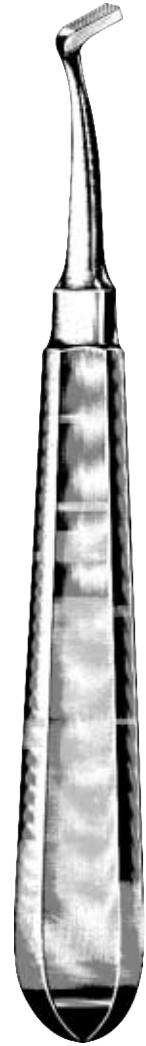

Mershon
UI34-528-01
Band Pusher
or Setter

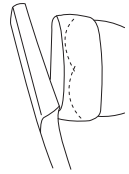
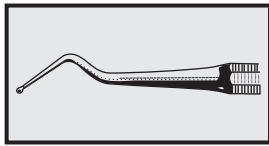

Swivel Lid for removing pins easily

2/3

UI34-555-00
55 mm Ø 17 mm



1/4

UI34-530-01



Steiner
UI34-532-01



Mod. Paris
UI34-5UI34-01

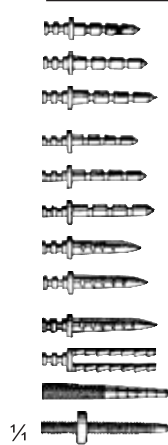

1/4

Fig.

1	UI34-552-01
2	UI34-552-02
3	UI34-552-03
4	UI34-552-04
5	UI34-552-05
6	UI34-552-06
7	UI34-552-07
8	UI34-552-08
9	UI34-552-09
10	UI34-552-10
14	UI34-552-14
15	UI34-552-15



UI34-540-01



UI34-549-30
10 m/32 ft. 10 in. x 0.3 mm Ø

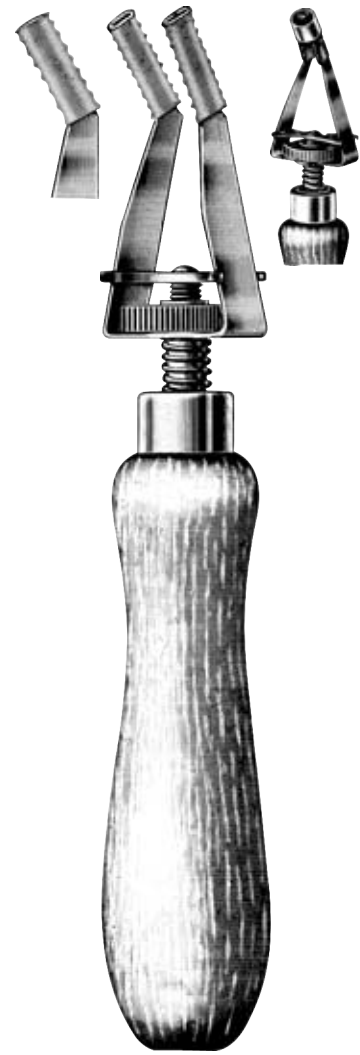

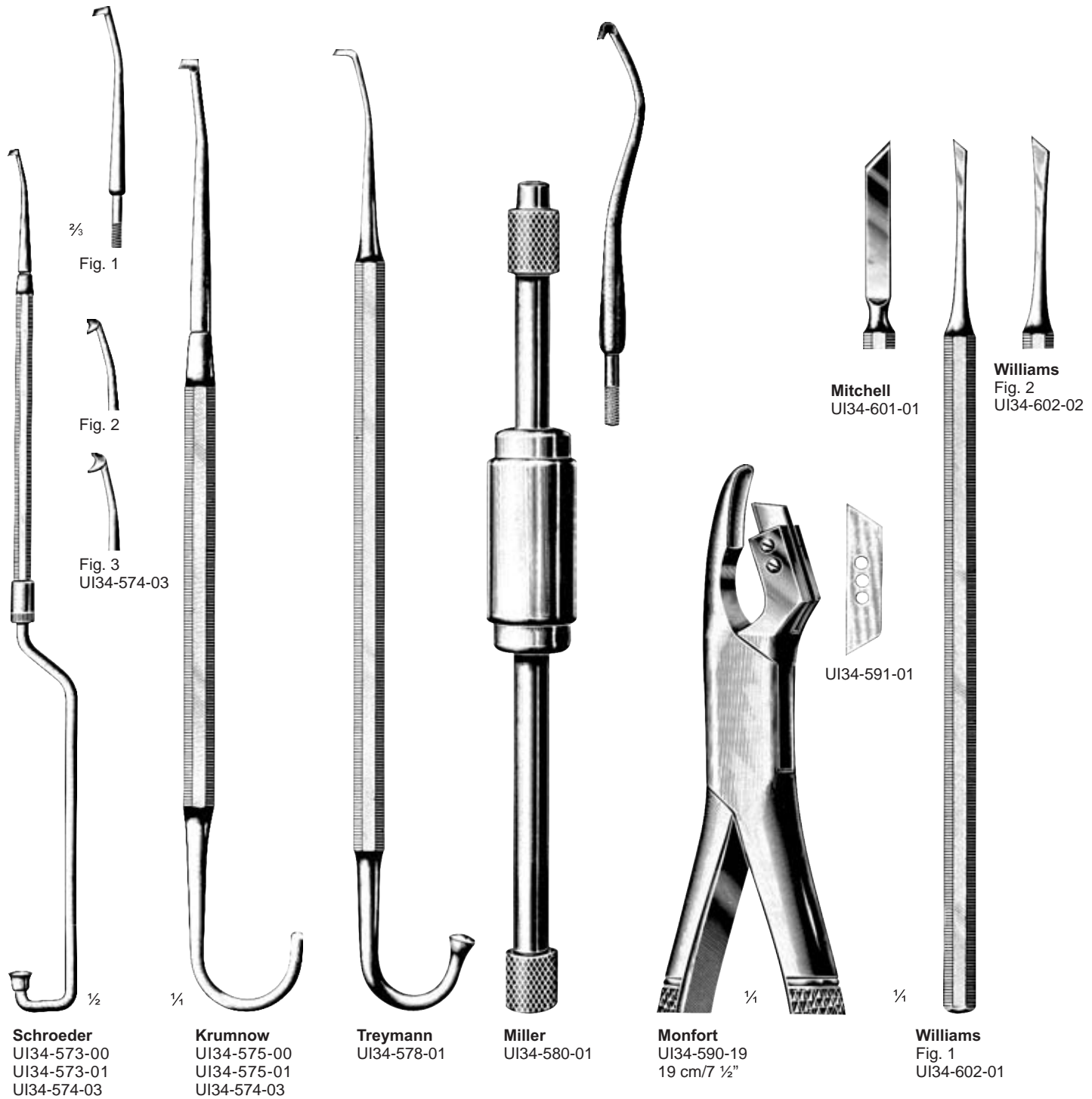
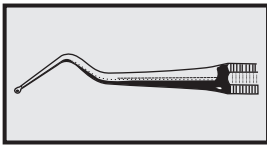



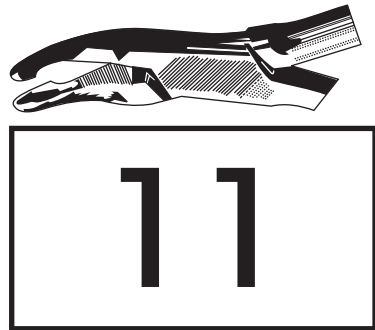

MALLETS, BONE ROUNGER & MOUTH GAGS

 URIYA Instruments®



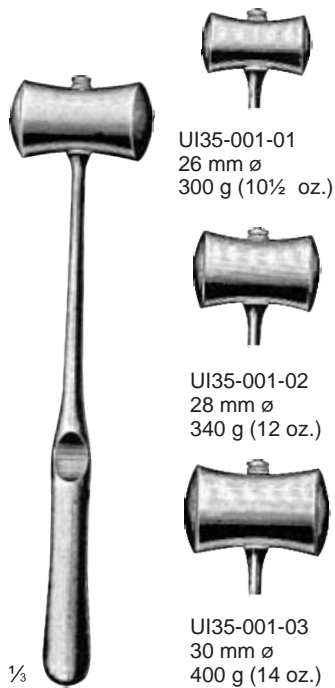
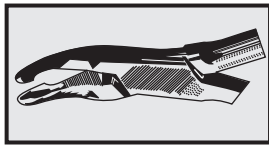

UI35-001-01
26 mm ø
300 g (10½ oz.)

UI35-001-02
28 mm ø
340 g (12 oz.)

UI35-001-03
30 mm ø
400 g (14 oz.)

Williger
24 cm / 9½"
lead filled

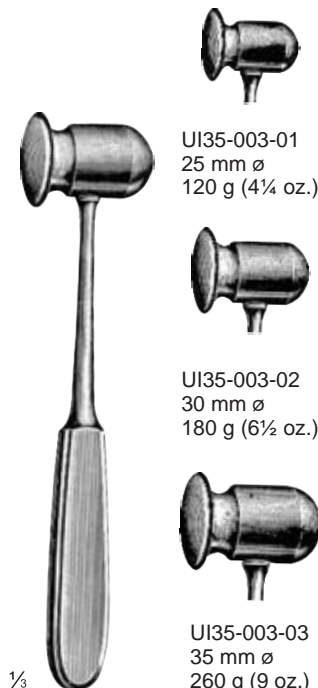

UI35-003-01
25 mm ø
120 g (4¼ oz.)

UI35-003-02
30 mm ø
180 g (6½ oz.)

UI35-003-03
35 mm ø
260 g (9 oz.)

Doyen
21 cm / 8¼"
brass, solid

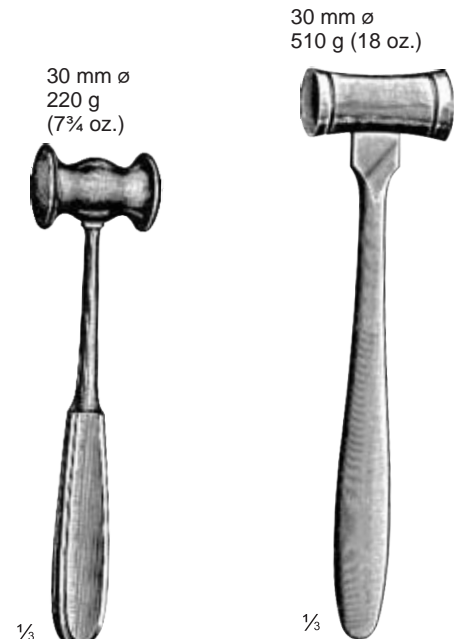

30 mm ø
220 g
(7¾ oz.)

Collin
UI35-005-20
20 cm / 8"
brass, solid

30 mm ø
510 g (18 oz.)

UI35-007-22
22.5 cm / 9"
steel, solid



26 mm ø
320 g (11¼ oz.)

Mead
UI35-009-17
17 cm / 6¾"
solid
UI35-009-00
Ferrozell Cheeks
only, pair

with interchangeable
Ferrozell Cheeks



20 mm ø
140 g
(5 oz.)

UI35-011-01
lead filled
UI35-011-02
brass, solid
16.5 cm / 6½"

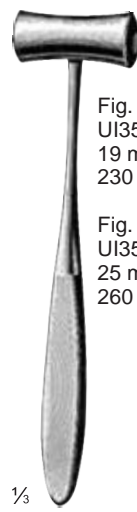

Fig. 1
UI35-013-01
19 mm ø
230 g (8 oz.)

Fig. 2
UI35-013-02
25 mm ø
260 g (9 oz.)

Luca
19 cm / 7½"
brass, solid



steel, solid,
with plastic handle

UI35-015-24
24 cm / 9½"

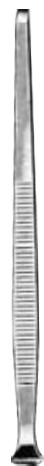
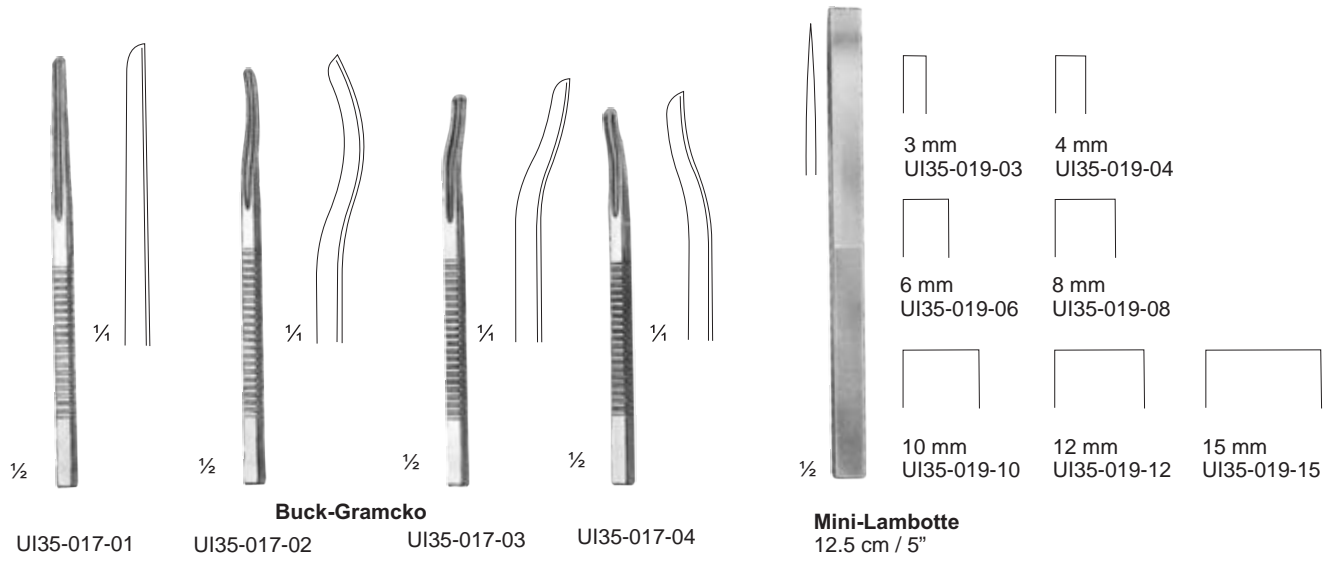
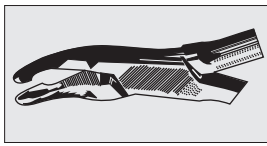

Partsch



Partsch

		width		
		mm		
11.5 cm/4½"	13.5 cm/5¼"		11.5 cm/4½"	13.5 cm/5¼"
UI35-021-02	UI35-023-02	2	UI35-025-02	UI35-027-02
UI35-021-03	UI35-023-03	3	UI35-025-03	UI35-027-03
UI35-021-04	UI35-023-04	4	UI35-025-04	UI35-027-04
UI35-021-05	UI35-023-05	5	UI35-025-05	UI35-027-05
UI35-021-06	UI35-023-06	6	UI35-025-06	UI35-027-06
UI35-021-07	UI35-023-07	7	UI35-025-07	UI35-027-07
UI35-021-08	UI35-023-08	8	UI35-025-08	UI35-027-08

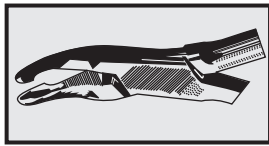

4 mm
UI35-029-04

6 mm
UI35-029-06

10 mm
UI35-029-10

8 mm
UI35-029-08

12 mm
UI35-029-12

Mini-Lexer
18 cm / 7"



4 mm
UI35-031-04

6 mm
UI35-031-06

10 mm
UI35-031-10

8 mm
UI35-031-08

12 mm
UI35-031-12

Mini-Lexer
18 cm / 7"



1/1
UI35-033-03
3 mm

1/1
UI35-033-00



Buckley
14 cm / 6 1/2"

UI35-033-04
4 mm

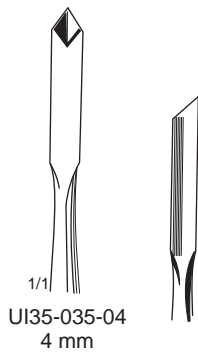

1/1
UI35-035-04
4 mm

Gardner
17.5 cm / 7"

UI35-037-04
4 mm



1/1
UI35-039-01
4 mm

1/1
UI35-039-02
5 mm

1/1
UI35-039-03
6 mm

1/1
UI35-039-04
4 mm

1/1
UI35-039-05
4 mm

1/1
UI35-039-06
5 mm

1/1
UI35-039-07
5 mm

1/1
UI35-039-08
5 mm

Walter F. Barry
21.5 cm / 9"

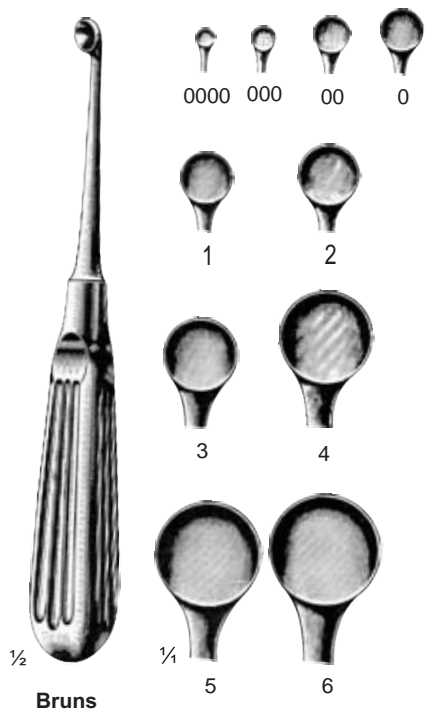
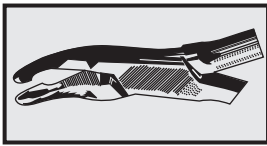

Bruns

UI35-041-40
UI35-041-30
UI35-041-20
UI35-041-10

UI35-043-01
UI35-043-02
UI35-043-03

UI35-043-04
UI35-043-05
UI35-043-06

Fig.
0000
000
00
0
0
1
2
3
4
5
6

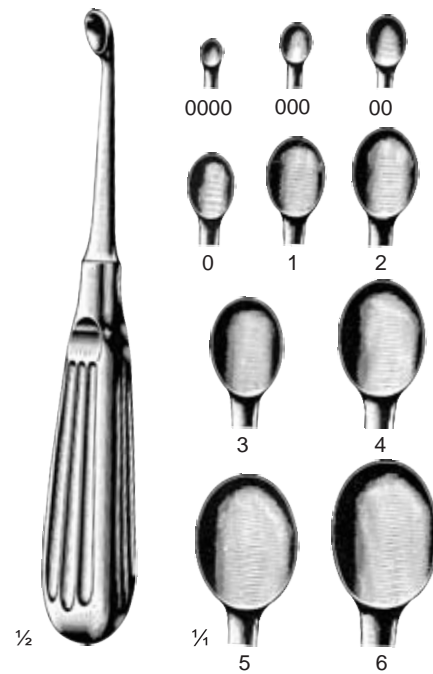

Volkmann

UI35-045-40
UI35-045-30
UI35-045-20

UI35-047-10
UI35-047-01
UI35-047-02

UI35-049-03
UI35-049-04
UI35-049-05
UI35-049-06

Fig.
0000
000
00
0
1
2
3
4
5
6

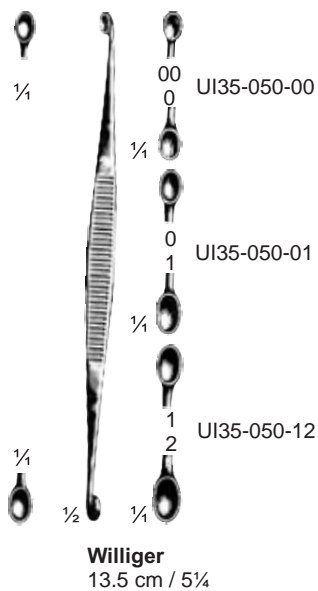

Williger
13.5 cm / 5 1/4"

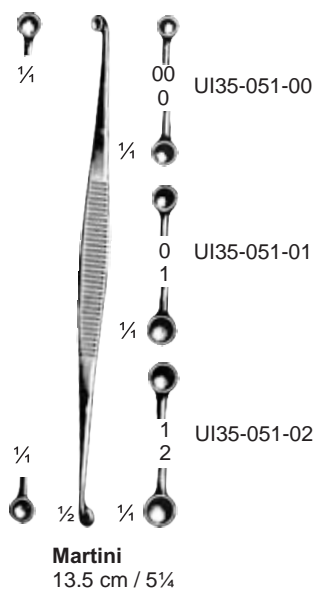

Martini
13.5 cm / 5 1/4"

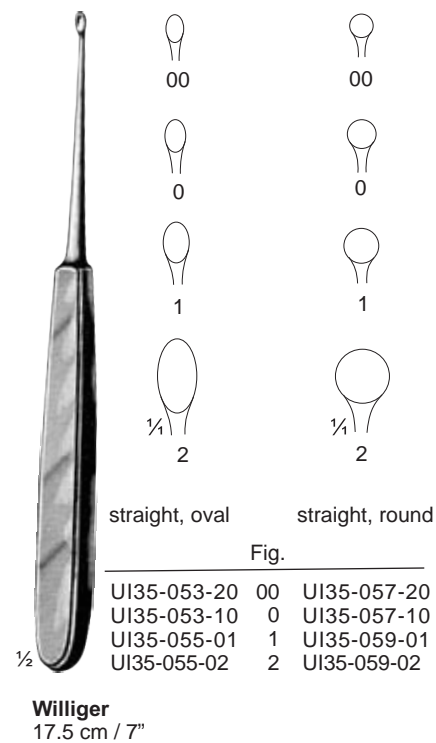

Williger
17.5 cm / 7"

	straight, oval	straight, round
UI35-053-20	00	UI35-057-20
UI35-053-10	0	UI35-057-10
UI35-055-01	1	UI35-059-01
UI35-055-02	2	UI35-059-02

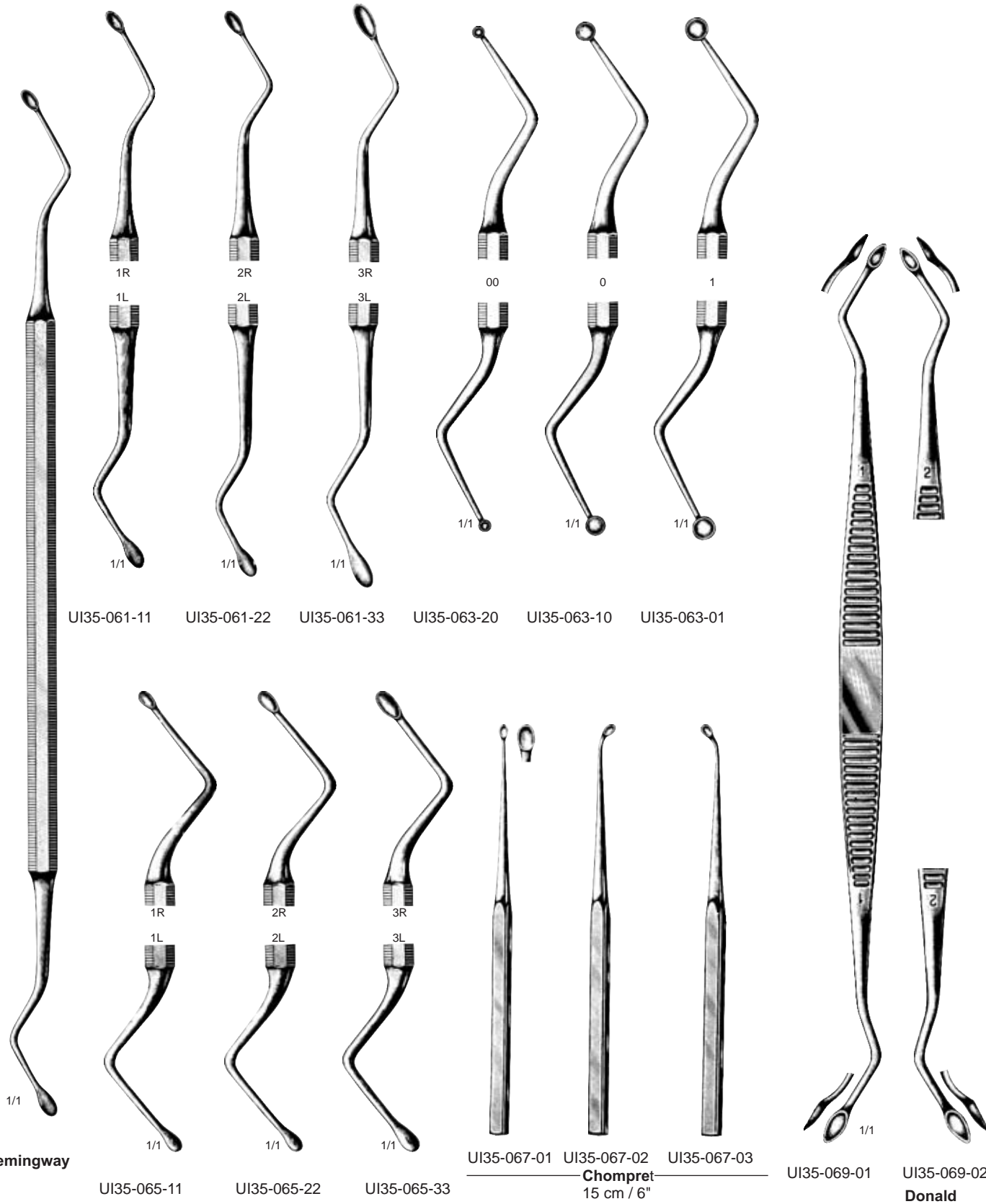
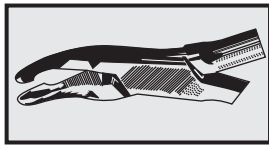

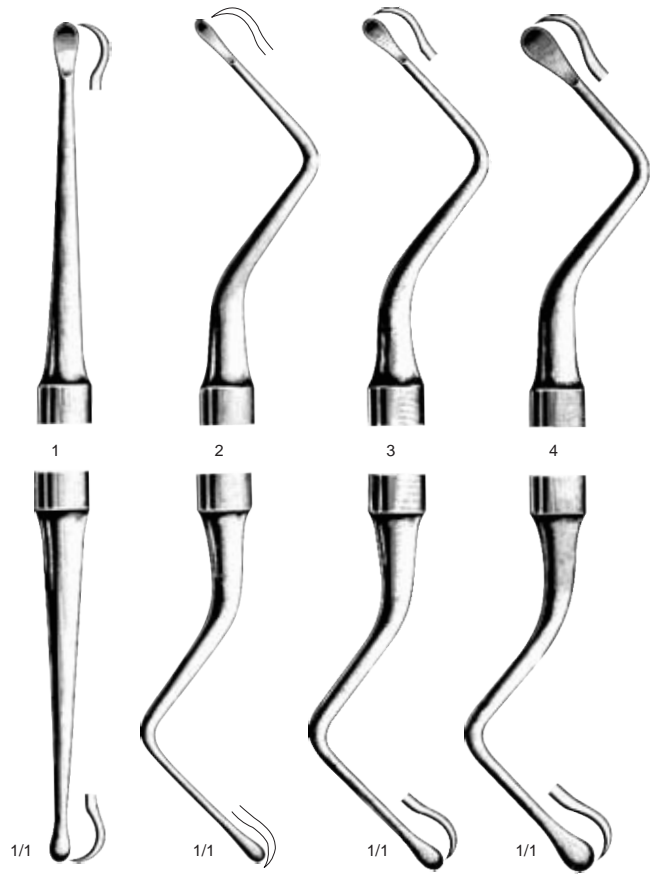
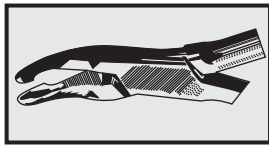

UI35-071-01 UI35-071-02 UI35-071-03 UI35-071-04

Miller-Colburn



UI35-073-01 UI35-073-02 UI35-073-03 UI35-073-04 UI35-073-05

Mead

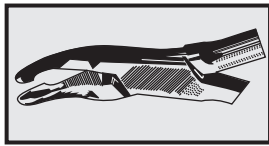

UI35-075-11

UI35-075-22

UI35-075-33

UI35-075-44

UI35-077-12

UI35-077-34

UI35-079-01

UI35-081-01

Lucas



UI35-083-01

UI35-083-02

UI35-083-03

UI35-083-04

UI35-083-05

Miller-Colburn

Williger
17 cm / 6 3/4"
UI35-085-17

Williger
16 cm / 6 1/4"
UI35-087-16

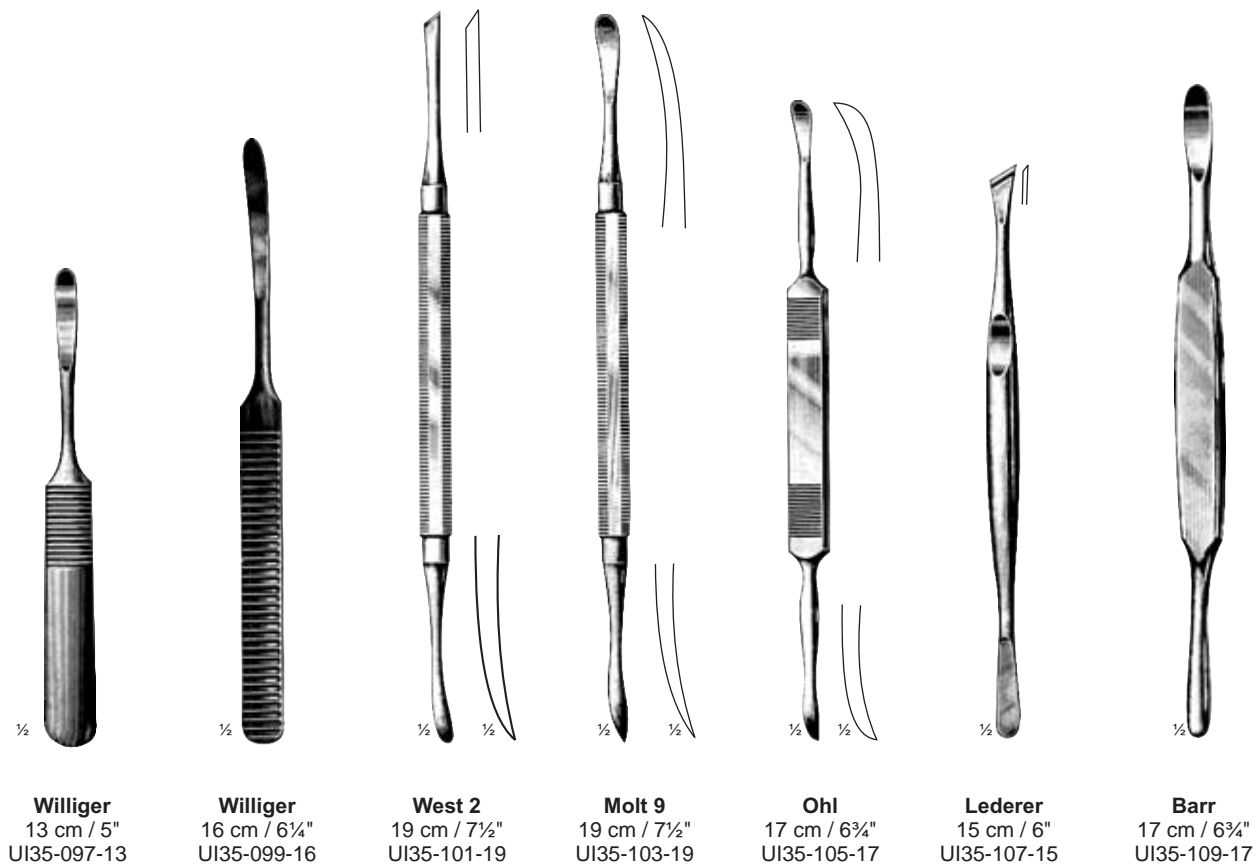
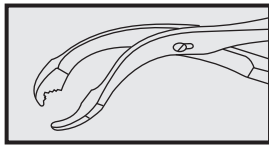

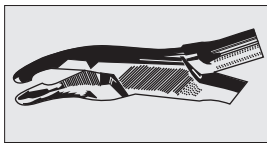

Frazier
13 cm / 5"
UI35-111-13



Kilner
UI35-113-15
15 cm/6"



Gillies
UI35-115-18
18 cm/7"



Knapp-Rollet
13 cm / 5"
UI35-117-02 (2 Teeth)
UI35-117-03 (3 Teeth)
UI35-117-04 (4 Teeth)



Barth
18 cm / 7"
UI35-119-18



Schwartz
11 cm / 4½"

Chisels	Width mm	Gouges
UI35-121-03	3	UI35-123-03
UI35-121-04	4	UI35-123-04
UI35-121-05	5	UI35-123-05
UI35-121-06	6	UI35-123-06
UI35-121-08	8	UI35-123-08
UI35-121-10	10	UI35-123-10



Schwartz
11 cm / 4½"



Fischer
15 cm / 5"



1/1
4 mm
UI35-125-04



1/1
5 mm
UI35-125-05



1/1
4 mm
UI35-125-04



1/1
5 mm
UI35-125-05



1/1
9 mm
UI35-125-09

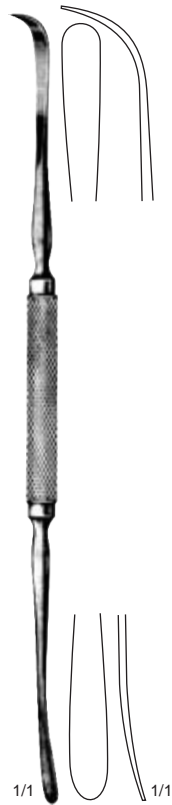
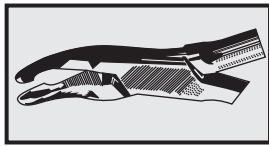

Freer
20 cm / 8"
UI35-129-20



Freer
16 cm / 6 1/4"
UI35-131-16
4 mm



Killian
16 cm / 6 1/4"
UI35-133-16

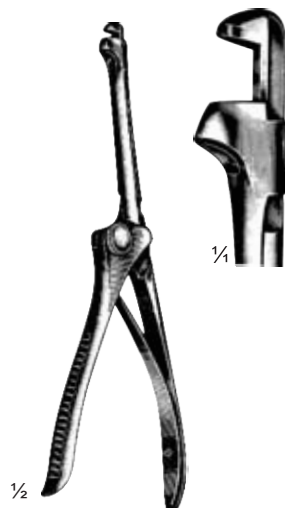

Hajeki-Calus
UI35-135-20 mm



Kerrison
UI35-137-17
UI35-137-05 mm
UI35-137-06 mm
UI35-137-07 mm

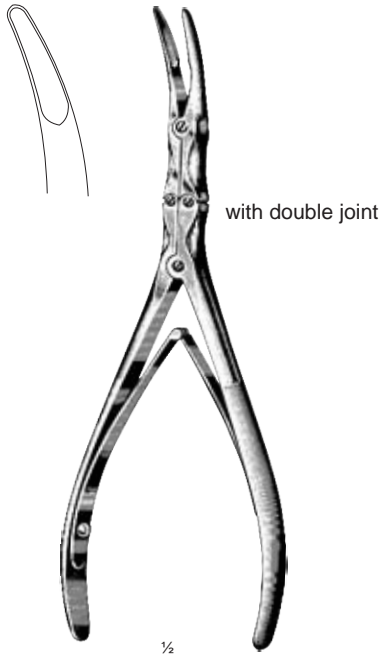
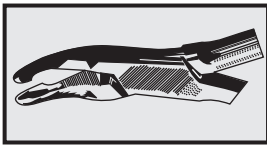

Beyer
18 cm / 7"
UI35-139-18



Cleveland
17 cm / 6 3/4"
UI35-141-17



Cleveland
15 cm / 6"
UI35-143-15



Cleveland
UI35-145-17
17 cm / 6 3/4"

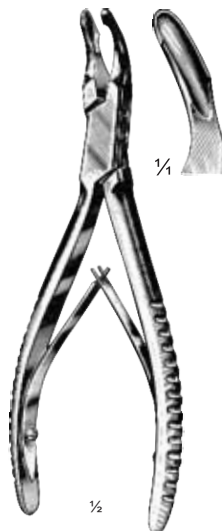

Cleveland
UI35-147-14
14 cm / 5 1/2"



Friedman
UI35-149-14
14 cm / 5 1/2"



Friedman-Mini
UI35-151-12
12 cm / 4 3/4"

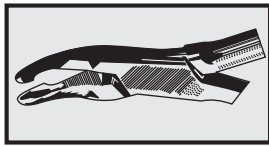

15 cm / 6"
UI35-153-15



Cleveland-Gardener
16 cm / 6¼"
UI35-155-16



Cleveland-Gardener
16 cm / 6¼"
UI35-157-16



18 cm / 7"
UI35-159-18



Luer
UI35-161-15
15 cm/6"

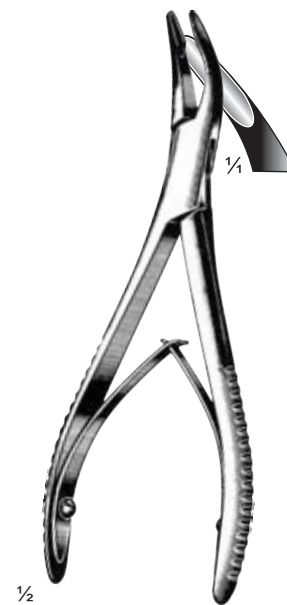

Luer
UI35-163-15
15 cm/6"

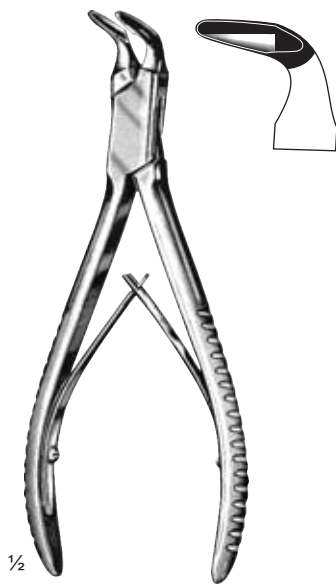
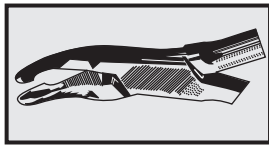

Blumenthal
15.5 cm/6"
UI35-165-15



Blumenthal
15.5 cm/6"
UI35-167-15



Blumenthal
15.5 cm/6"
UI35-169-15



Hartmann
18.5 cm / 7 1/4"
UI35-171-18



Mead
16.5 cm/6 1/2"
UI35-173-16

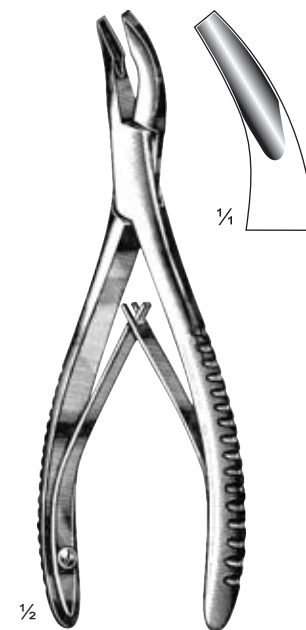

Mead
16.5 cm/6 1/2"
UI35-175-16

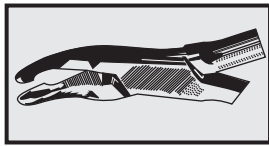

½

Heister
13 cm/5"
UI35-177-13



½

Doyen-Jansen (Molt)
12 cm/4 ¾"
UI35-179-12
Child



½

Doyen-Jansen (Molt)
14 cm/5 ½"
UI35-181-14
Adult



½

Denhart
12 cm/4 ¾"
UI35-183-12



½

Roser-Koeing

cm	in	UI
16	6 ¼	UI35-185-16
19	7 ½	UI35-185-19

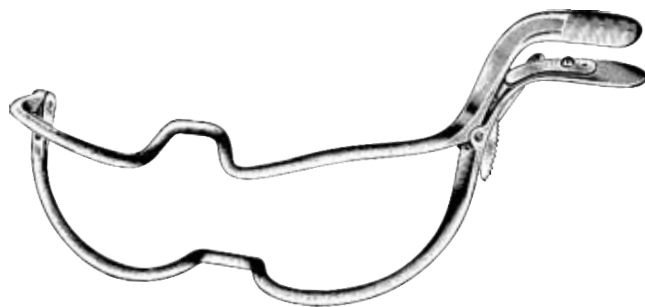

Jenning

cm	in	UI
09	3 ½	UI35-189-09
11	4 ¼	UI35-189-11
13	5	UI35-189-13
15	6	UI35-189-15

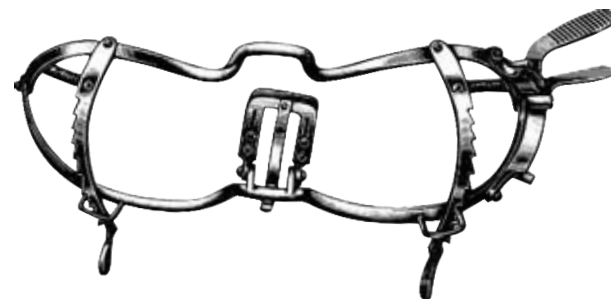

Whitehead

cm	in	UI
11	4 ¼	UI35-191-11
13	5	UI35-191-13
15	6	UI35-191-15

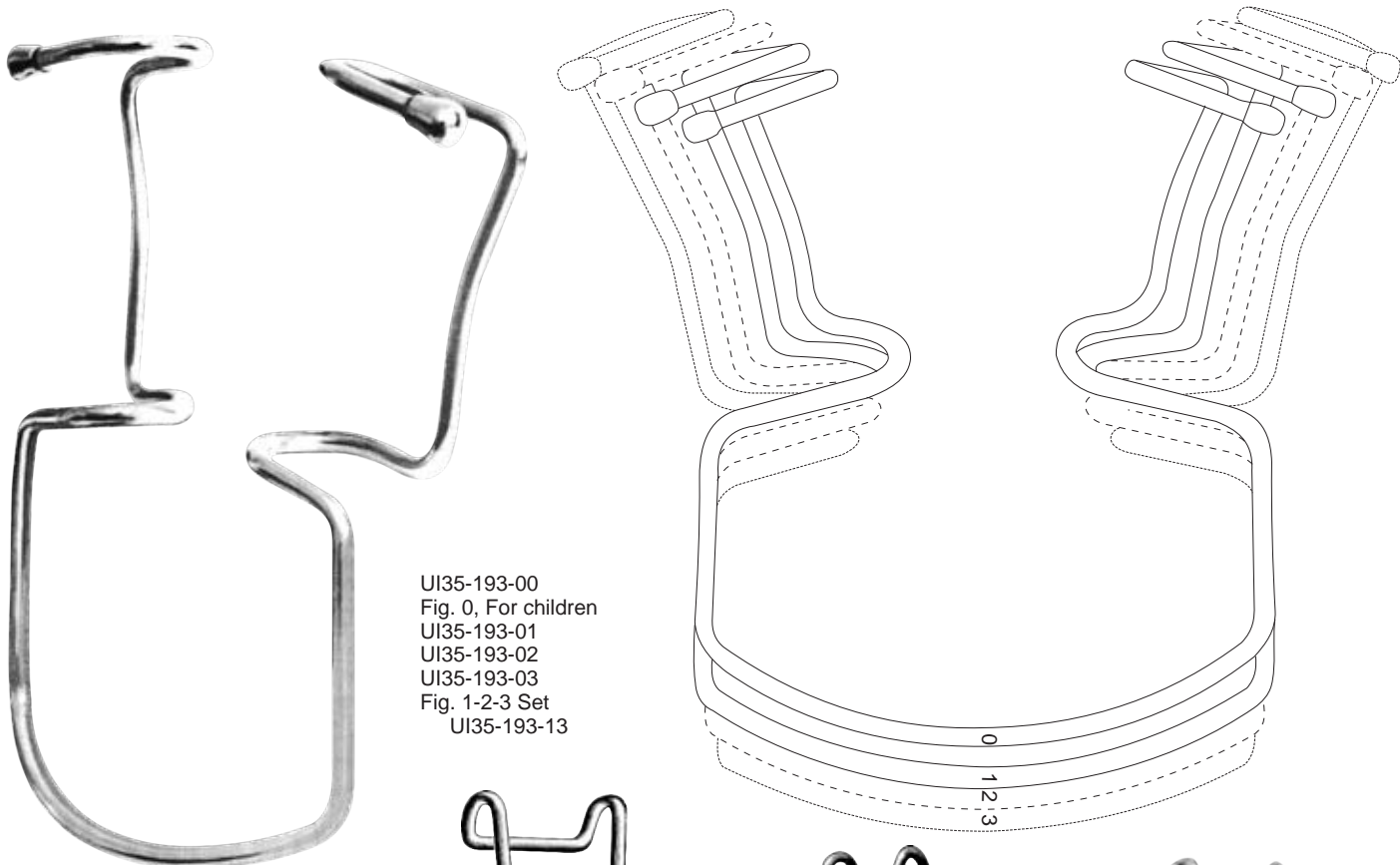
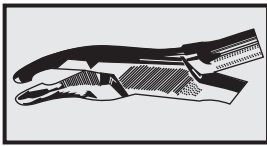

UI35-193-00
Fig. 0, For children
UI35-193-01
UI35-193-02
UI35-193-03
Fig. 1-2-3 Set
UI35-193-13



11 cm/4 1/4"
UI35-194-11

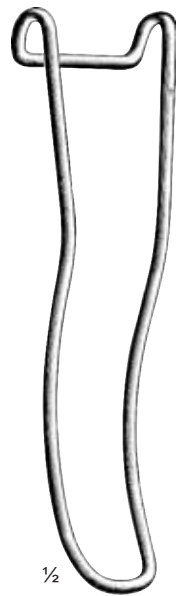

1/2



1/2



1/2

19 cm/7 1/2"
UI35-203-19

Sternmerg		
	cm	in
UI35-195-12	12	4 3/4
UI35-195-14	14	5 1/2
UI35-195-16	16	6 1/4

UI35-199-12	UI35-201-11	Cheek Retractor
UI35-199-14	UI35-201-12	Lip Retractor
UI35-199-16	UI35-201-14	Lip Retractor
UI35-199-18	UI35-201-16	Lip Retractor
UI35-199-21	UI35-201-18	Lip Retractor
	UI35-201-19	Cheek Retractors

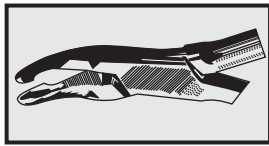

1/2

Hartmann
15 cm/6"
UI35-205-15

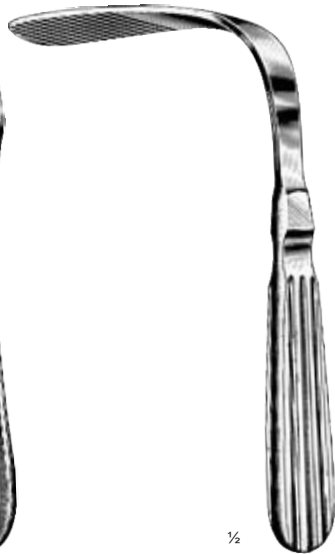

1/2

Tobold
14.5 cm / 5 1/2"
UI35-207-14

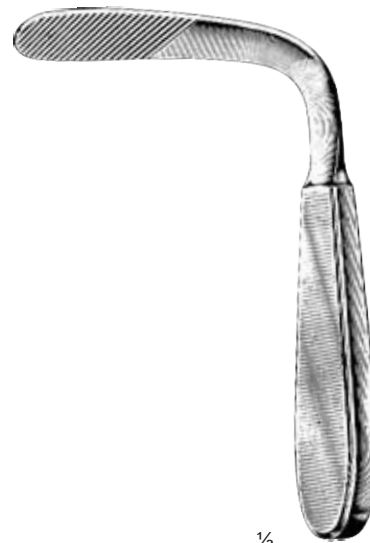

1/2

Tobold
14.5 cm/5 3/4"
UI35-209-14



1/2

Andrew
11 cm/4 1/4"
UI35-211-11

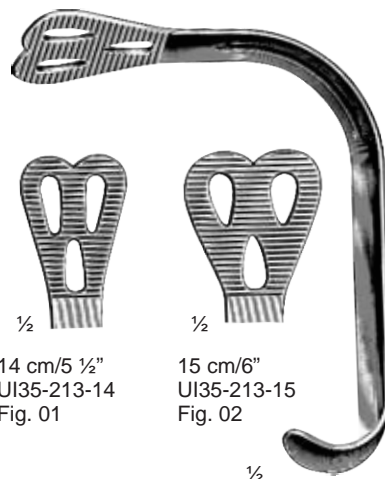

1/2

14 cm/5 1/2"
UI35-213-14
Fig. 01

1/2

15 cm/6"
UI35-213-15
Fig. 02

1/2

Wieder

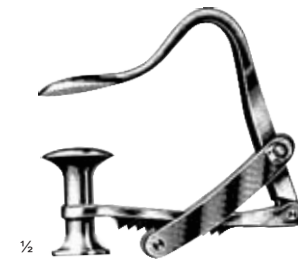

1/2

Rottenstein-Schreite
UI35-215-00

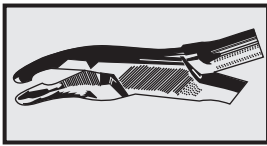

Doyen
cm in.
13 5 UI35-217-13
16 6¼ UI35-217-16



UI35-219-00
UI35-219-00



Zuafix
UI35-221-00

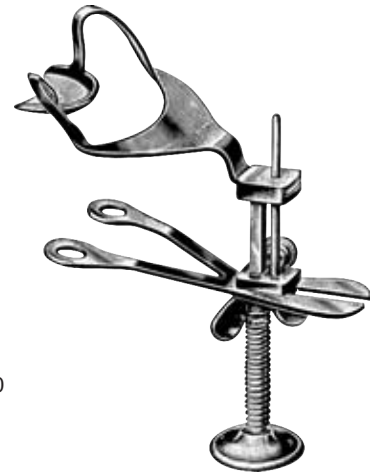

Tobold
UI35-227-14
14.5 cm / 5 ¾"

Tobold
14.5 cm / 5 ½"
UI35-225-14

Hartmann
UI35-223-15
15 cm / 6"



Andrew
UI35-229-11
11 cm / 4 ¼"

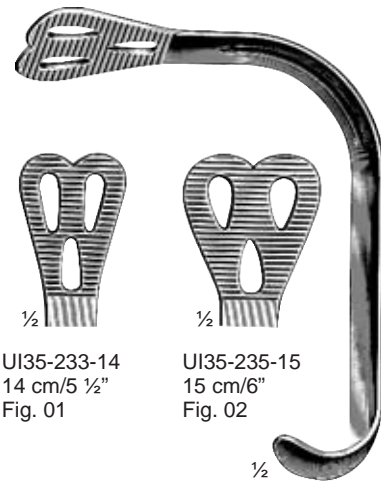

UI35-233-14
14 cm / 5 ½"
Fig. 01

UI35-235-15
15 cm / 6"
Fig. 02

Wieder



Rottenstein-Schreite
UI35-231-00

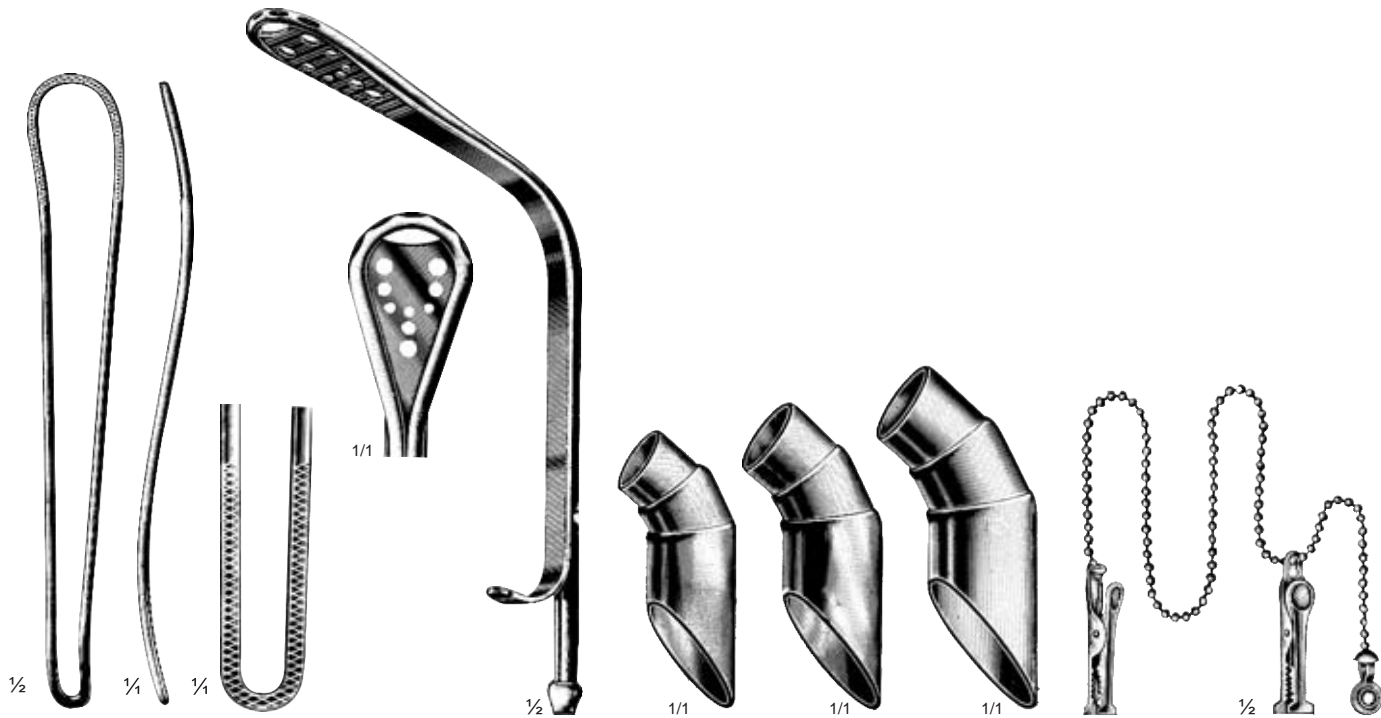
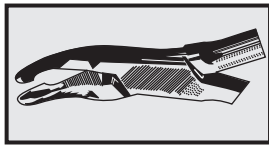

Frenzel
UI35-237-16
16.5 cm/6"

Le Mee
UI35-239-01

UI35-241-01

Langenbeck
UI35-243-02

UI35-245-03

UI35-247-01



Adams
UI35-249-01

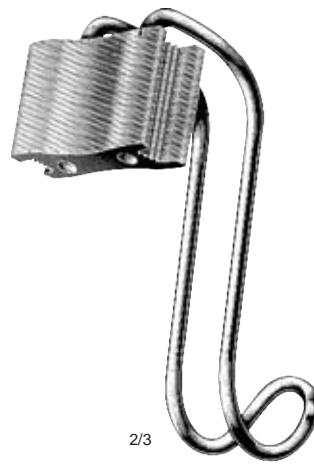

Pitha
UI35-251-00



Pitha
UI35-253-00



Baisch
UI35-255-00

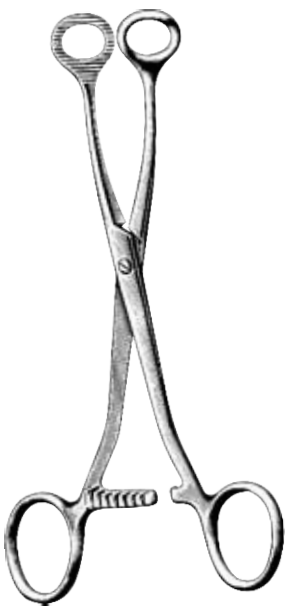
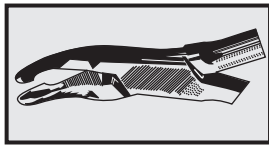

½

Collin

cm	in	
16	6 ¼	UI35-257-16
18	7	UI35-257-18

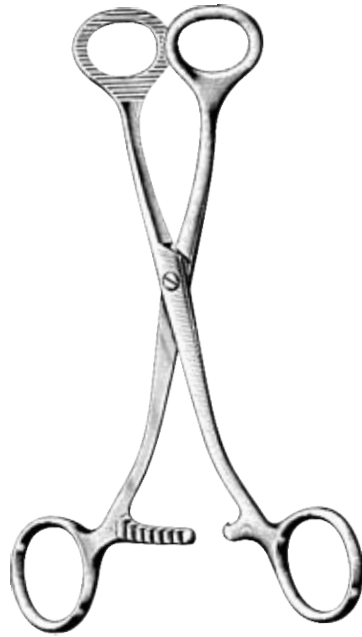

Collin

UI35-259-17
17 cm / 6¾"



½

Young

16 cm / 6 ¼"
UI35-261-16



½

Hartmann

UI35-263-01
For children / Women



Hartmann

UI35-265-01
Regular Size



Hartmann

UI35-267-01

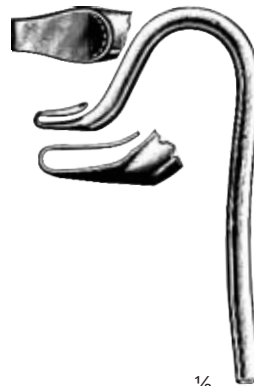

½

Fluofix



UI35-269-02

UI35-269-01

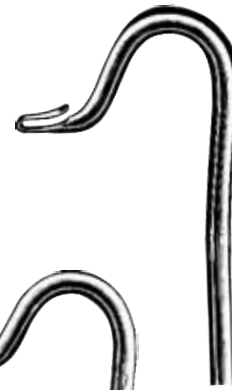

UI35-269-03

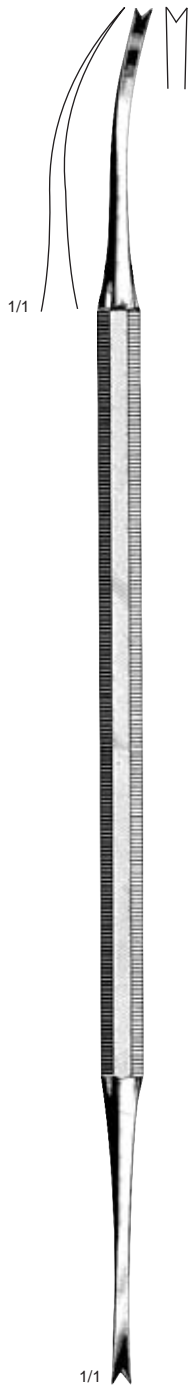
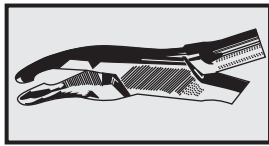

Luniatschek
18.5 cm / 7¼"
UI35-271-18

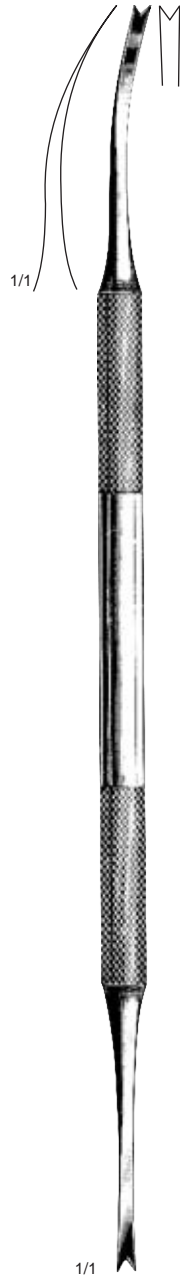

Luniatschek
17 cm / 6¾"
UI35-273-17



Claus
23 cm / 9"
UI35-275-23



Durham
25 cm / 10"
UI35-277-25



Durham
25 cm / 10"
UI35-279-25

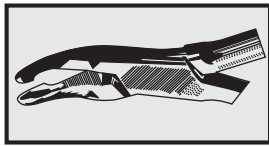

1/1

17 cm / 7"
UI35-281-17



1/1



Brophy
19 cm / 7½"
UI35-283-19

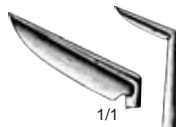

1/1



Whitehead
19 cm / 7½"
UI35-285-19



1/1



Whitehead
19 cm / 7½"
UI35-287-19

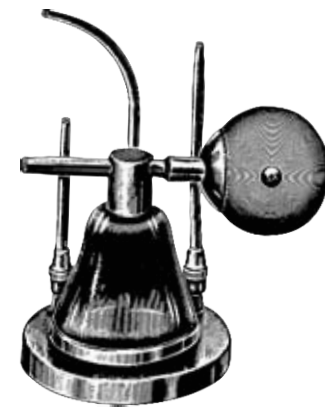

Kabiarske
UI35-289-00



8 cm / 3¼"
UI35-291-08

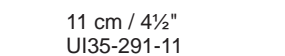

11 cm / 4½"
UI35-291-11

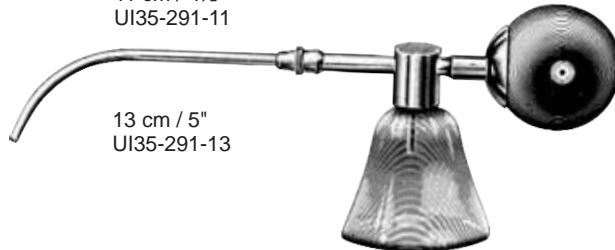

13 cm / 5"
UI35-291-13

Kabiarske
UI35-291-00

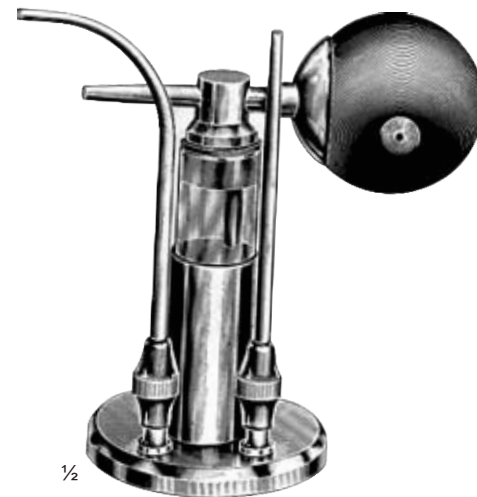

1/2

Halle-Hebderich
UI35-293-00

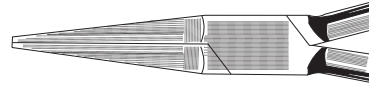

12

Pliers

 URIYA Instruments®

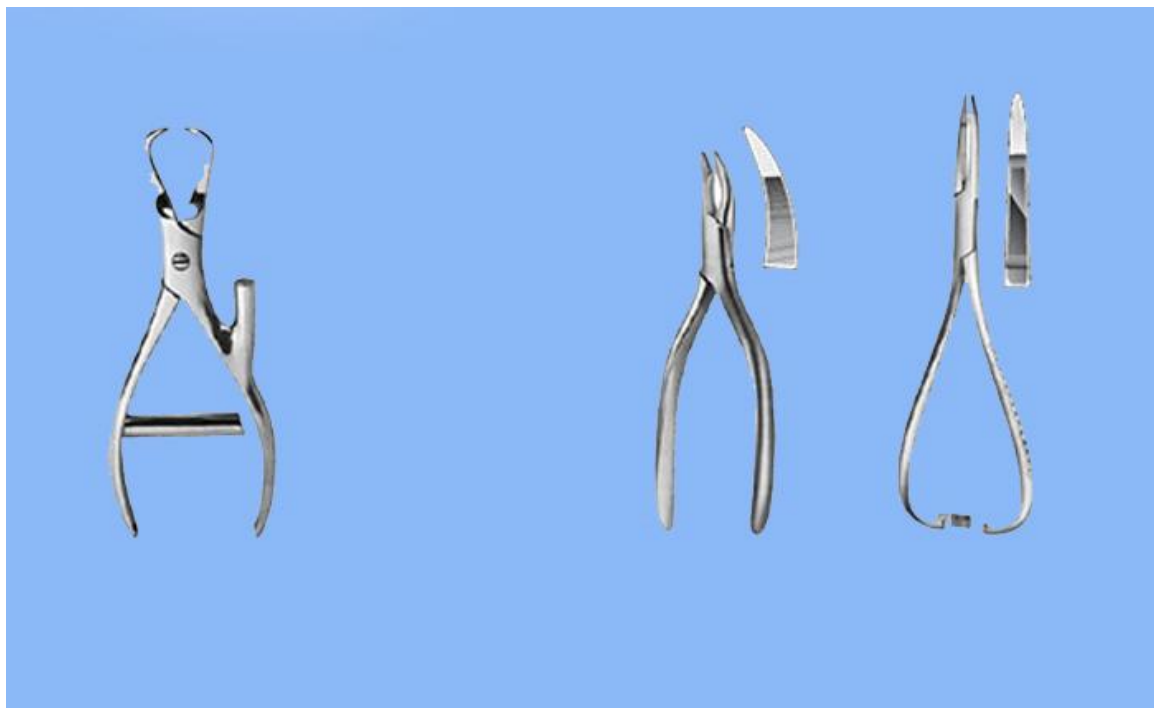

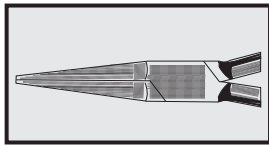

Lodo
15 cm \ 6"
UI36-001-15
Pliers for Removing
Bridges and Crowns.

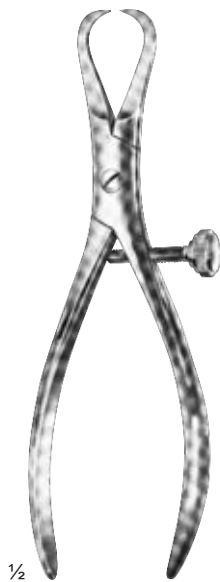

Furrer
15 cm \ 6"
UI36-003-15
Copper Ring Removing Pliers



Weingart
14 cm \ 5½"
UI36-005-14
Wire Seizing and
Ligature Pliers

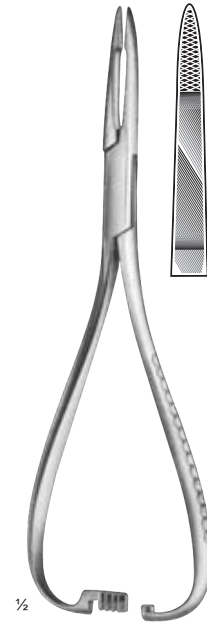

15 cm \ 6"
UI36-007-15
Wire Seizing and
Ligature Pliers

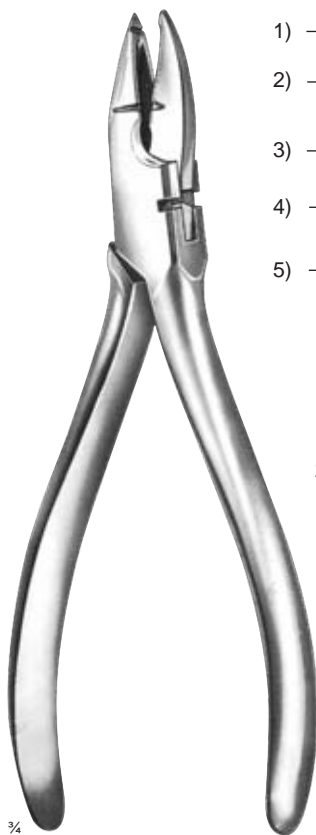

Waldsachs-Universal
15.5 cm \ 6"
UI36-009-15
Universal Pliers

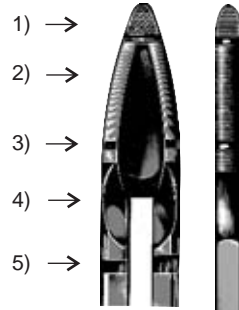

- to be used as:
1) Pin and Ligature Pliers
2-3) Clasp Bending Pliers
4) Bar Bending Pliers
5) Cutting Pliers



Universal
15.5 cm \ 6"
UI36-011-15
Universal Pin Roughening,
Cutting and Bending Forceps



Universal
15.5 cm \ 6"
UI36-011-15

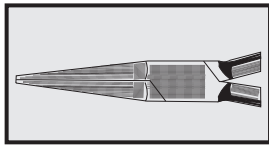

McKellops
16 cm \ 6¼"
UI36-013-16

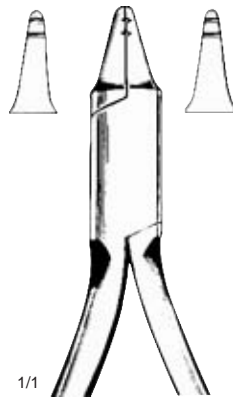

Oliver
12.5 cm \ 5"
UI36-015-12

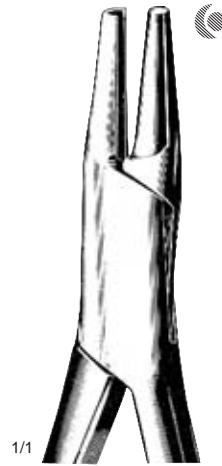

McKellops
17 cm \ 6¾"
UI36-017-17

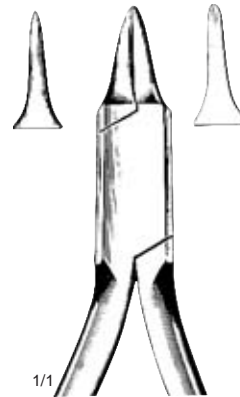

Waldron
12.5 cm \ 5"
UI36-019-12

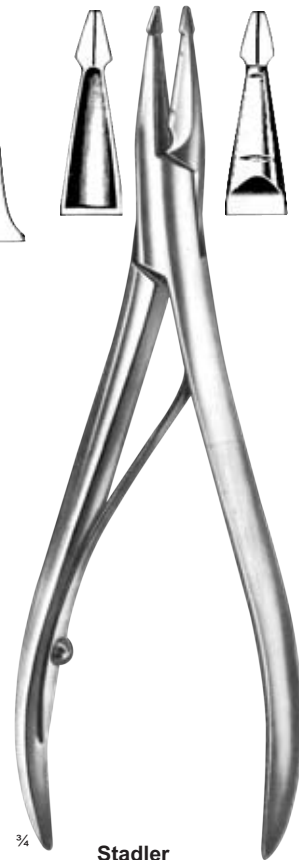

Stadler
15 cm \ 6"
UI36-021-15

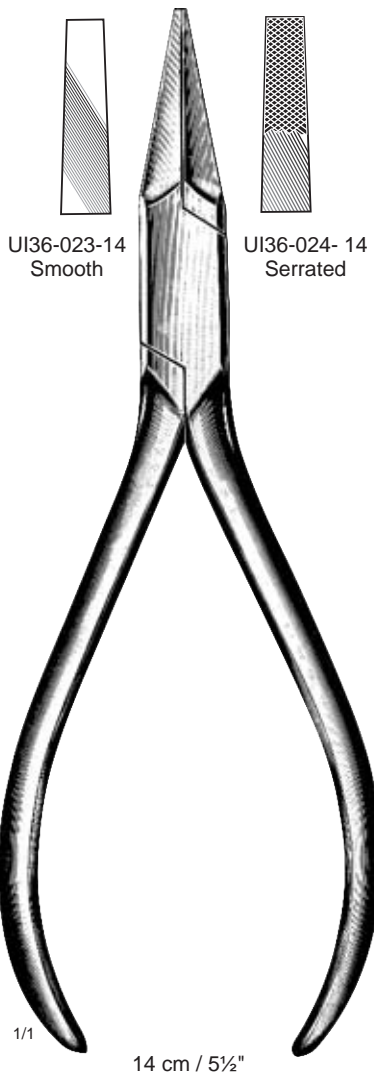

UI36-023-14
Smooth

UI36-024- 14
Serrated

14 cm / 5½"

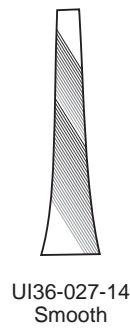

UI36-027-14
Smooth



UI36-029- 14
Serrated



Langenbeck
14 cm / 5½"

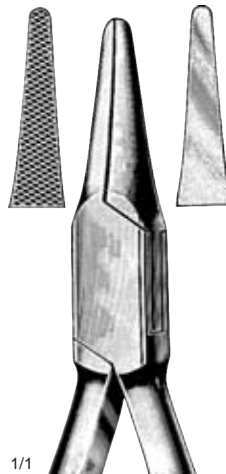

Goslee
14 cm / 5½"
UI36-025-14



UI36-031-12
Smooth

UI36-033- 12
Serrated

12.5 cm / 5"

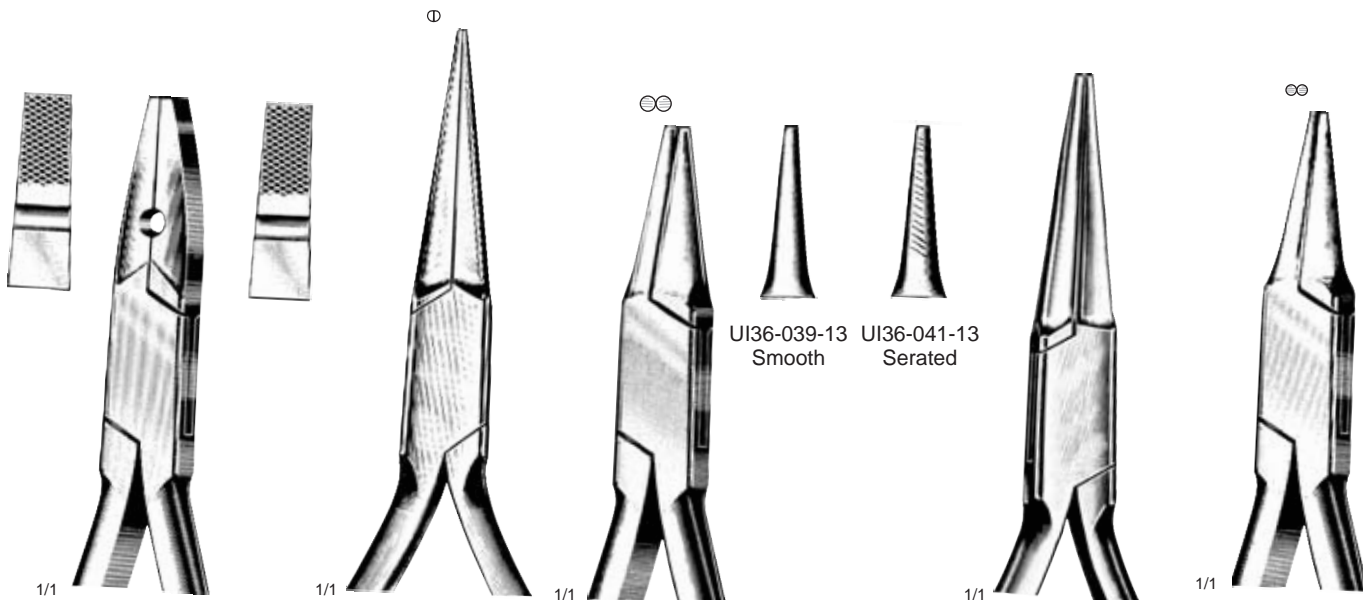
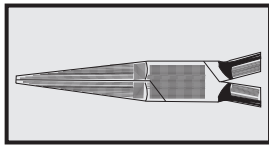

1/1 14 cm / 5½" UI36-035-14 1/1 **Langenbeck** 14 cm / 5½" UI36-037-14 1/1 13 cm / 5" 1/1 **Langenbeck** 14 cm / 5½" UI36-043-14 1/1 13 cm / 5" UI36-045-13

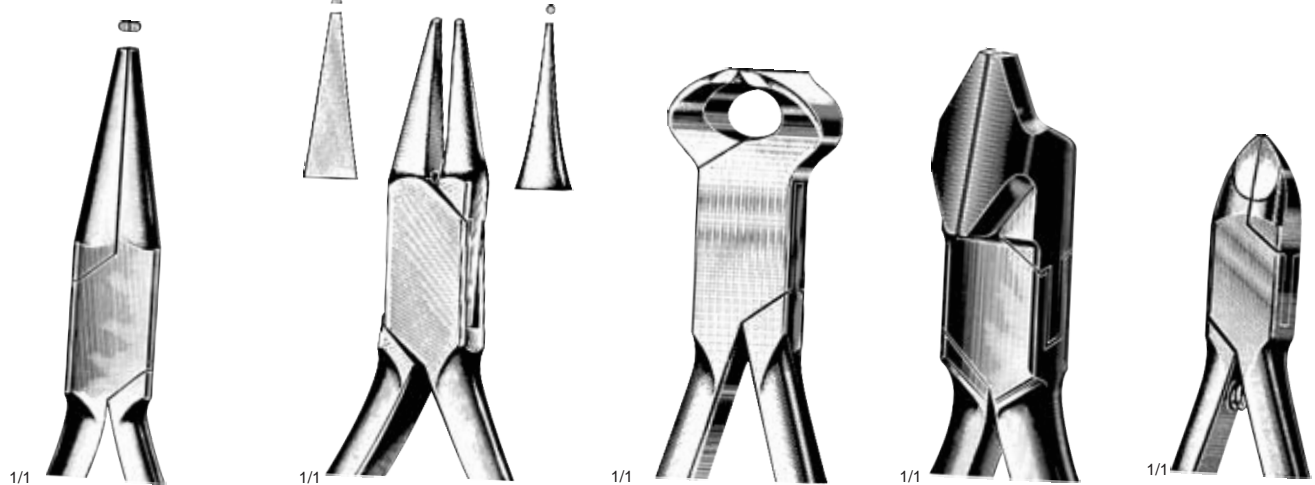

1/1 13 cm / 5" UI36-047-13 1/1 15 cm / 6" UI36-049-15 1/1 12.5 cm / 5" UI36-051-12 1/1 13 cm / 5" UI36-053-13 1/1 11 cm / 4½" UI36-055-11

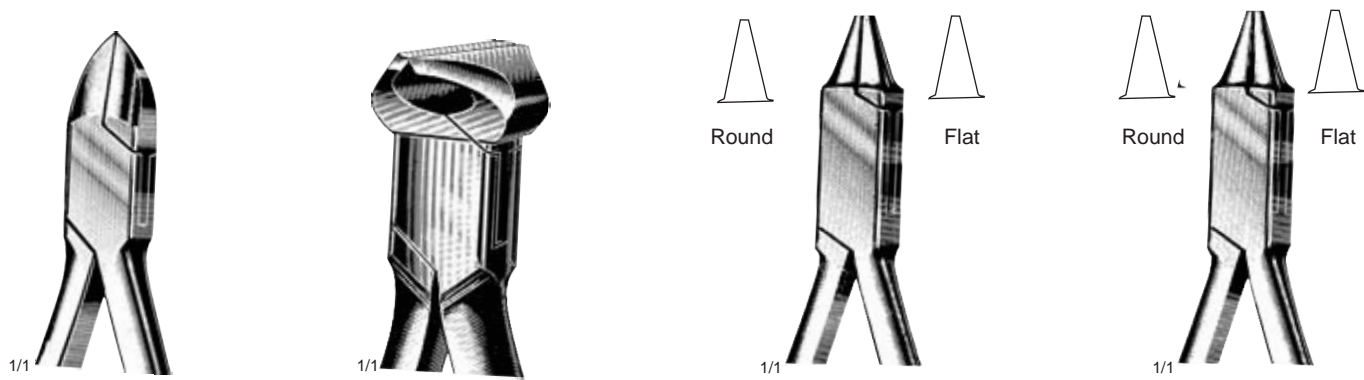

1/1 11 cm / 4½" UI36-057-11 1/1 12 cm / 4½" UI36-059-12 1/1 **Angle** 12 cm / 4¾" UI36-061-12 1/1 12 cm / 4¾" UI36-063-12

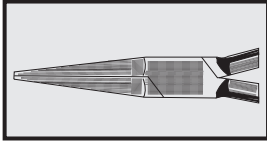

Flat and Nose Pliers end Nippers
Clasp and Arch Bending Pliers
Ligature Pliers



Dumont
11.5 cm / 4 1/2"

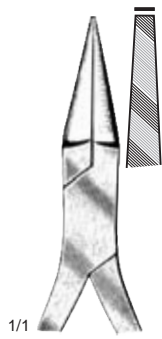

1/1
UI36-065-11

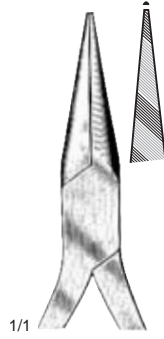

1/1
UI36-067-11

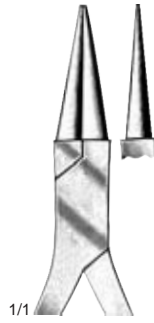

1/1
UI36-069-11



Dumont
11.5 cm / 4 1/2"



1/1
UI36-071-11



1/1
UI36-073-11

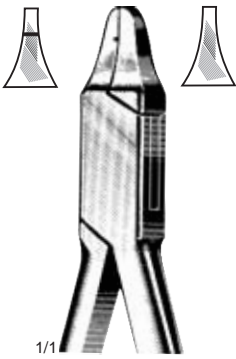

Angle
13 cm / 5"
UI36-075-13

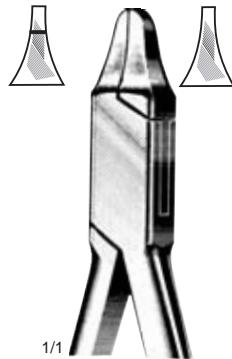

Angle
13 cm / 5"
UI36-077-13

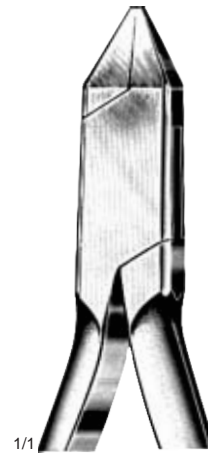

Adams
13 cm / 5"
UI36-079-13



Aderer
13 cm / 5"
UI36-081-13

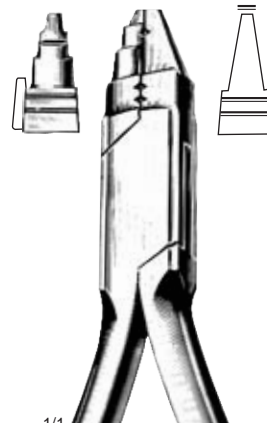

Young
13 cm / 5"
UI36-083-13



Aderer
14 cm / 5 1/2"
UI36-085-14

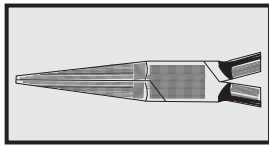

1/1
Aderer
11.5 cm / 4½"
UI36-087-11

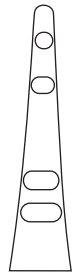

1/1
Aderer
14 cm / 5½"
UI36-089-14

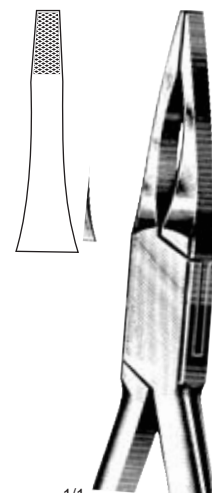

1/1
Fischer
13.5 cm / 5¼"
UI36-091-13



1/1
Diamant
16 cm / 6¼"
UI36-093-16

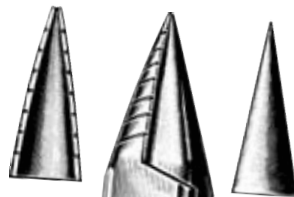

1/1
Schwarz
14.5 cm / 5¾"
UI36-094-14



1/1
Fischer
14 cm / 5½"
UI36-095-14



1/1
Andresen
14 cm / 5½"
UI36-097-14

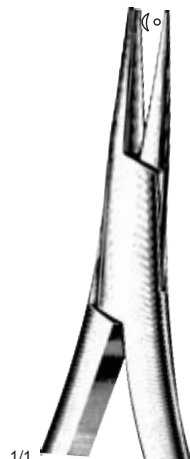

1/1
Schwarz
13 cm / 5"
UI36-099-13



1/1
Schwarz
13 cm / 5"
UI36-101-13



1/1
Schwarz
13 cm / 5"
UI36-103-13

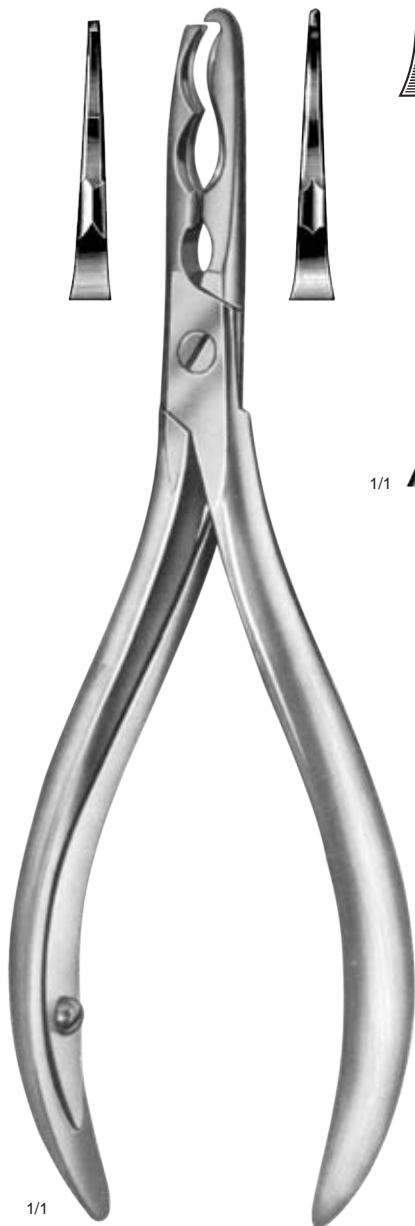
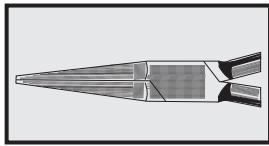

Tryfus
16.5 cm / 6½"
UI36-105-16

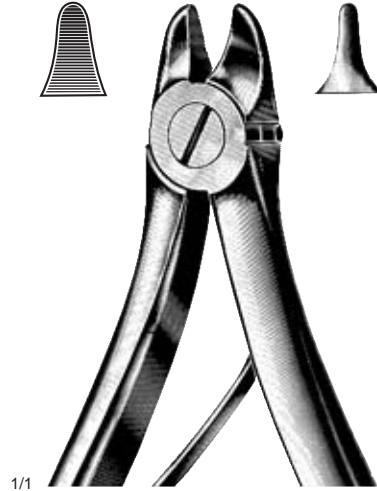

Peeso
14.5 cm / 5¾"
UI36-107-14

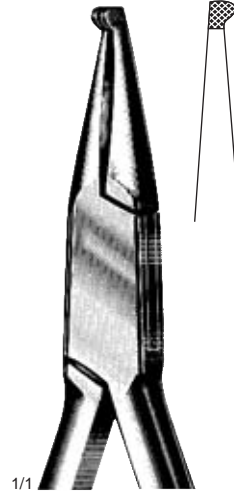

How
14 cm / 5½"
UI36-109-14

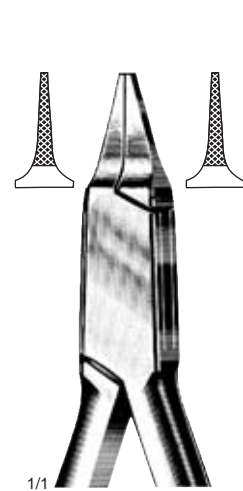

Frevert
12 cm / 4¾"
UI36-111-12

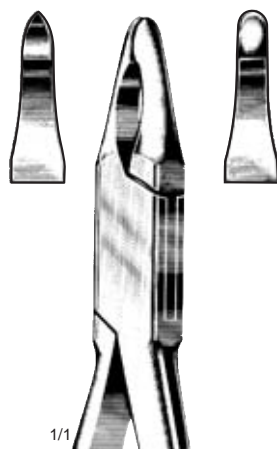

Johnson
13 cm / 5"
UI36-113-13

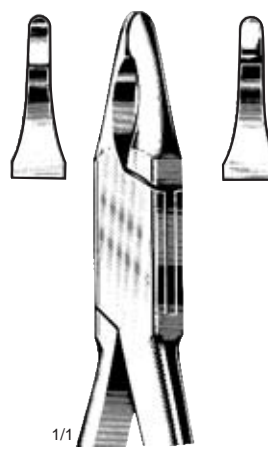

Johnson
13 cm / 5"
UI36-115-13

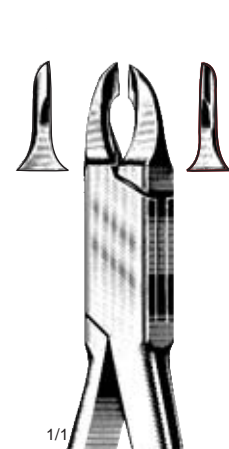

Angle
13 cm / 5"
UI36-117-13

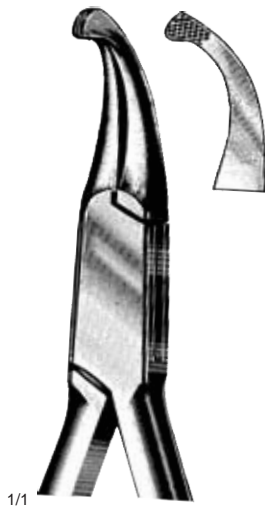
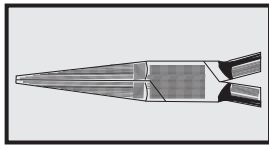

1/1
How
14 cm / 5½"
UI36-119-14



1/1
Ziebe
13 cm / 5"
UI36-121-13

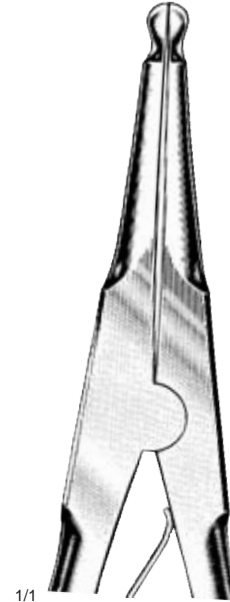

1/1
Herbst
14 cm / 5½"
UI36-123-14

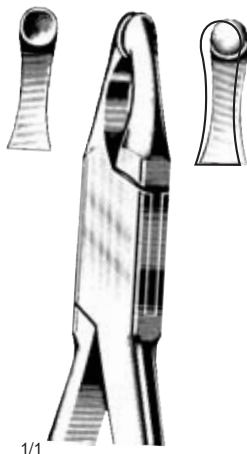

1/1
Abell
13 cm / 5"
UI36-125-13

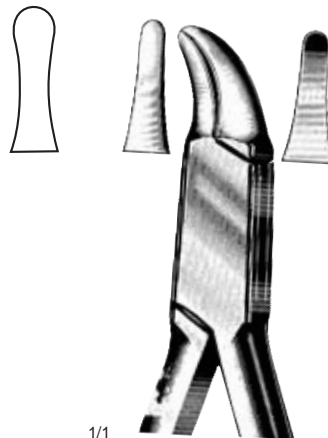

1/1
Reynolds
12.5 cm / 5"
UI36-127-12

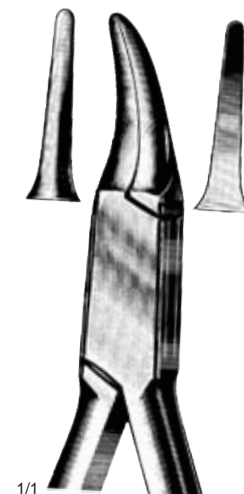

1/1
Gordon
14 cm / 5½"
UI36-129-14

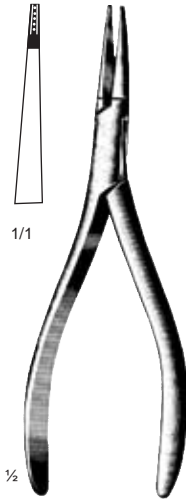
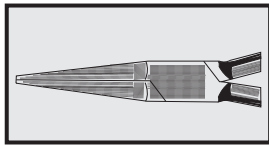

1/1
1/2
13 cm / 5"
UI36-131-13

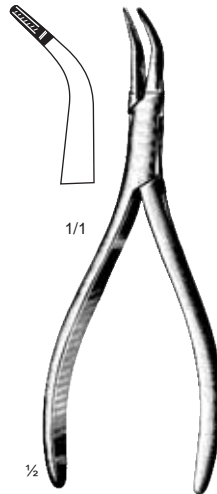

1/1
1/2
13 cm / 5"
UI36-133-13

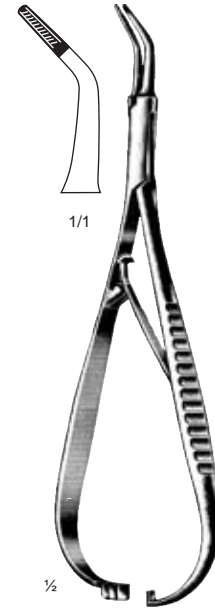

1/1
1/2
16 cm / 6¼"
UI36-135-16

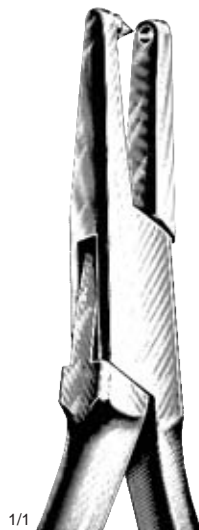

1/1
Ainworth
16 cm / 6¼"
UI36-137-16

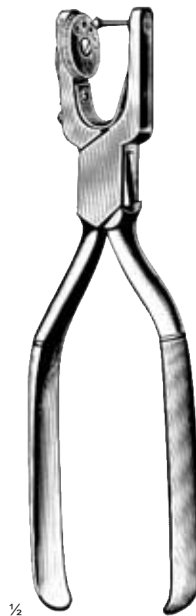

1/2
Tuttle
15 cm / 6"
UI36-139-15

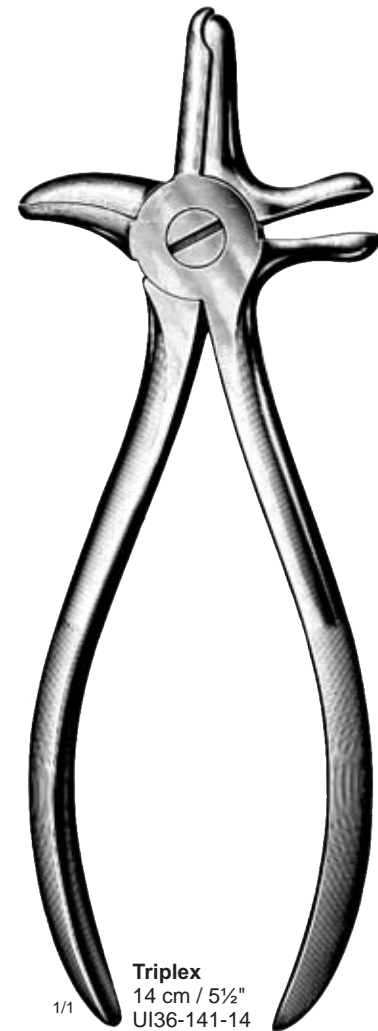

1/1
Triplex
14 cm / 5½"
UI36-141-14

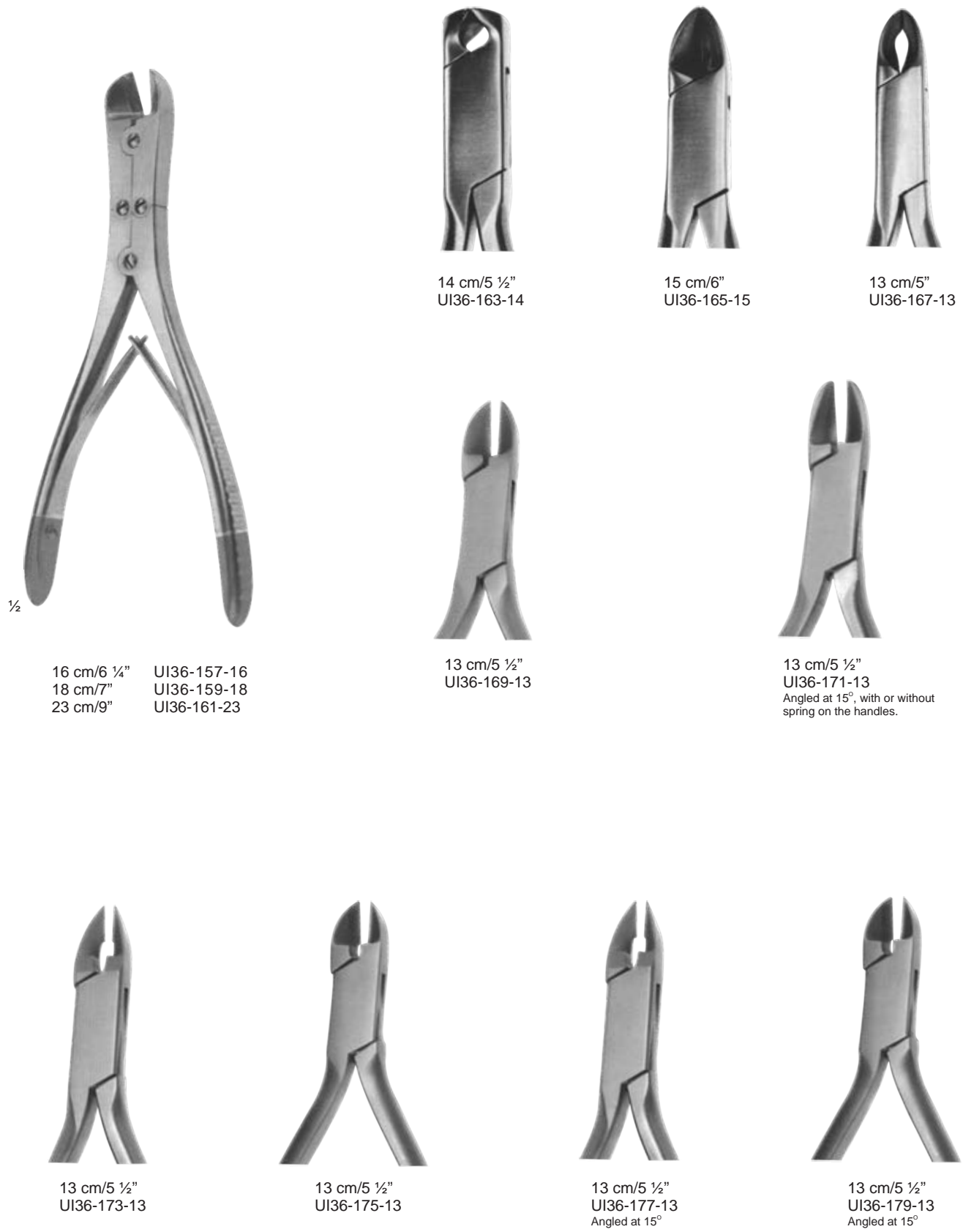
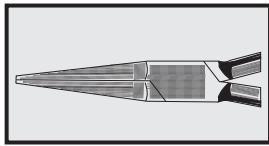

1/2

16 cm/6 1/4" UI36-157-16
18 cm/7" UI36-159-18
23 cm/9" UI36-161-23

14 cm/5 1/2" UI36-163-14

15 cm/6" UI36-165-15

13 cm/5" UI36-167-13

13 cm/5 1/2" UI36-169-13

13 cm/5 1/2" UI36-171-13
Angled at 15°, with or without spring on the handles.

13 cm/5 1/2" UI36-173-13

13 cm/5 1/2" UI36-175-13

13 cm/5 1/2" UI36-177-13
Angled at 15°

13 cm/5 1/2" UI36-179-13
Angled at 15°

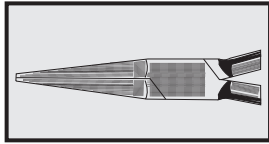

13 cm/5 1/2"
UI36-181-13



13 cm/5 1/2"
UI36183-13



15 cm/6"
UI36-185-15
Hard wire 0.55x0.64
Long handle



13 cm/5 1/2"
UI36-187-13



13 cm/5 1/2"
UI36-189-13

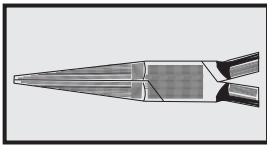

Diagonal Wire Cutter
13 cm/5 1/2"
UI35-191-13

Parallel Action Wire Cutter
11 cm/4 1/2"
UI35-195-11



Parallel Action Wire Cutter
11 cm/4 1/2"
UI35-197-11

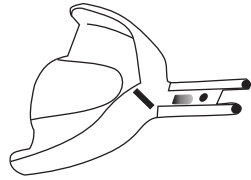

13

Articulators & Impression Trays

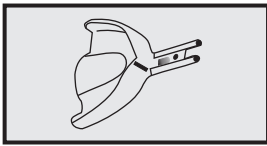

UI37-001-00

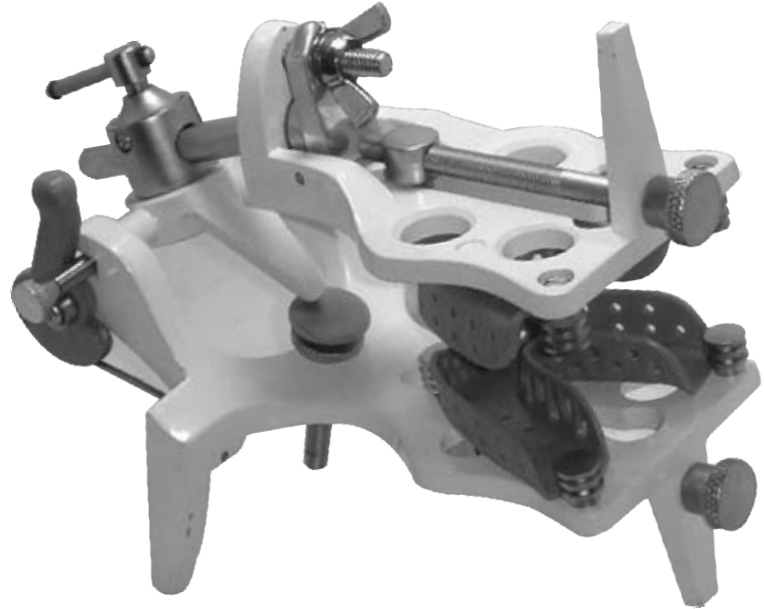

UI37-003-00



UI37-005-00

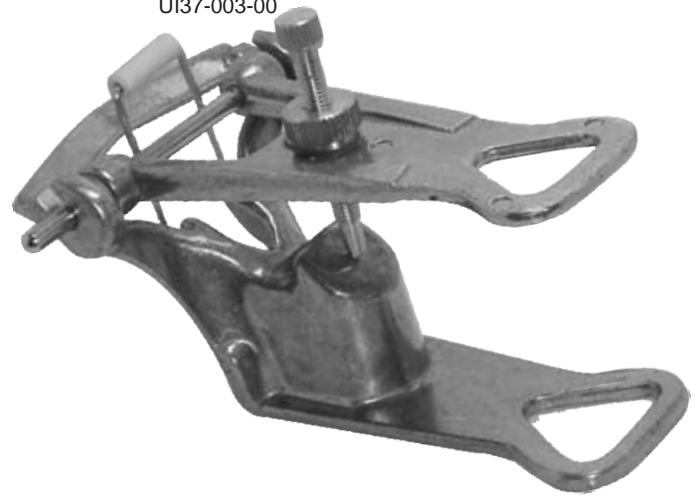

UI37-007-00



UI37-009-00

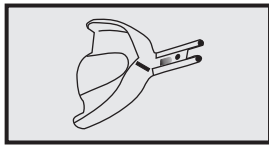

UI37-011-00



UI37-013-00



UI37-015-00



UI37-017-00

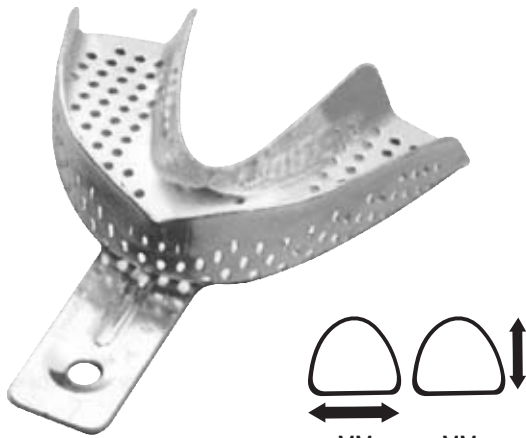
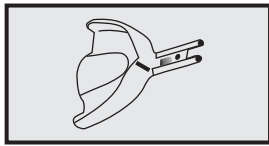

		MM	MM
UI37-019-U1	XXS	63	48
UI37-019-U2	XS	66	51
UI37-019-U3	S	68	54
UI37-019-U4	M	71	58
UI37-019-U5	L	74	62
UI37-019-U6	XL	76	63

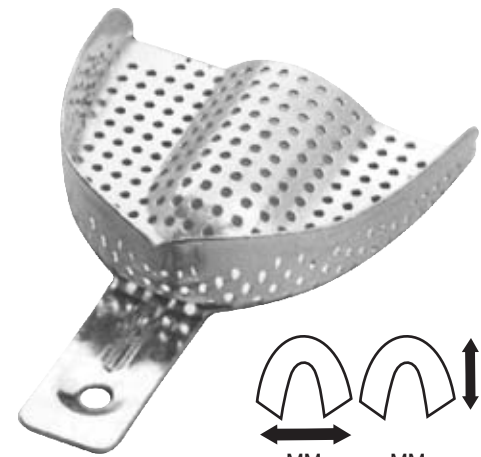

		MM	MM
UI37-021-L1	XXS	56	48
UI37-021-L2	XS	59	50
UI37-021-L3	S	72	52
UI37-021-L4	M	76	57
UI37-021-L5	L	77	56
UI37-021-L6	XL	78	59

Set of Twelve UI37-022-12

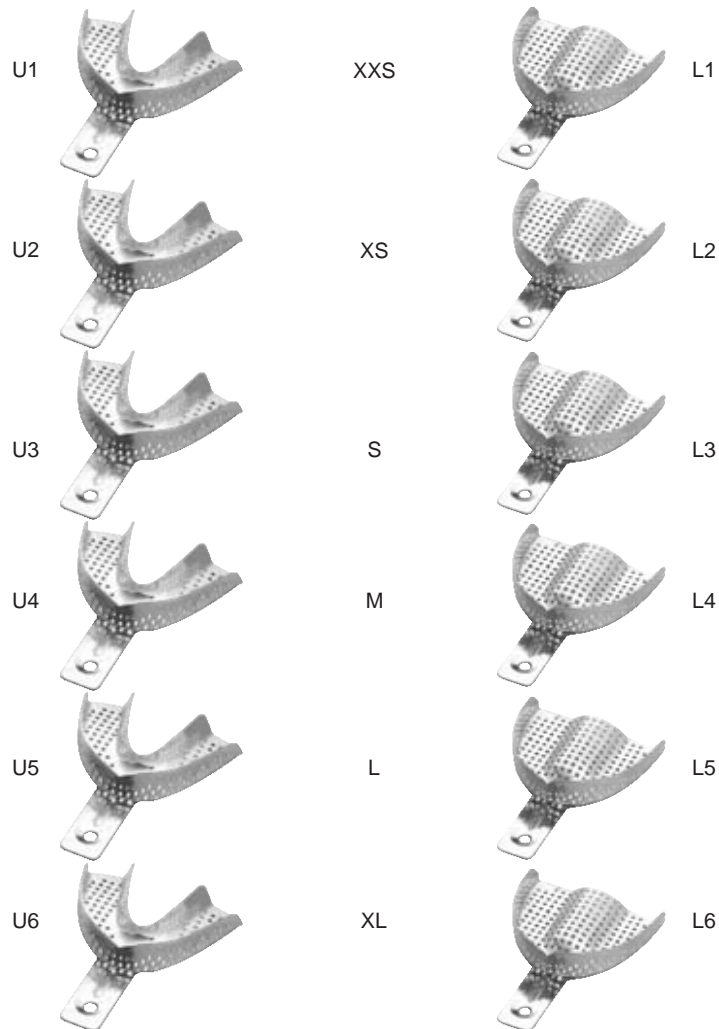

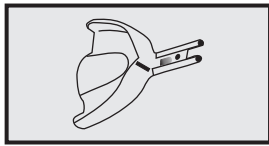

		MM	MM
UI37-023-U1	L	81	67
UI37-023-U4	M	71	64
UI37-023-U7	S	70	57

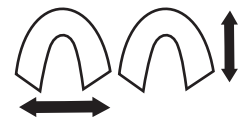

		MM	MM
UI37-025-L20	L	81	60
UI37-025-L21	M	79	57
UI37-025-L22	S	76	54

Set of Six UI37-027-06

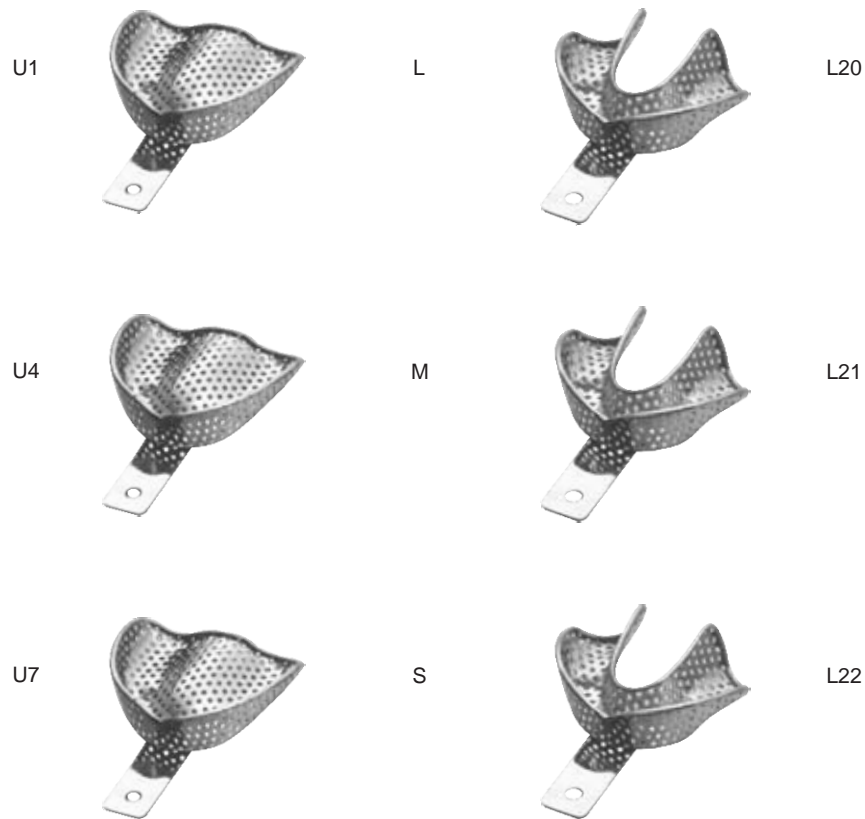

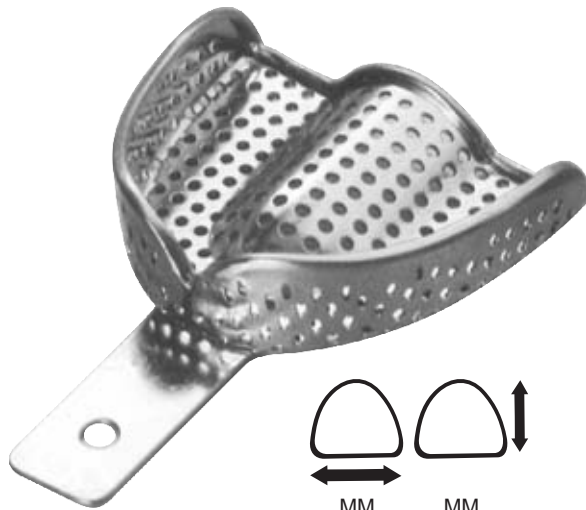
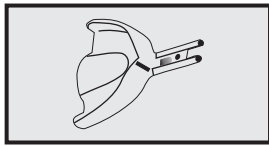

		MM	MM
UI37-029-U1	XXS	63	47
UI37-029-U2	XS	64	51
UI37-029-U3	S	66	53
UI37-029-U4	M	69	57
UI37-029-U5	L	71	60
UI37-029-U6	XL	73	62

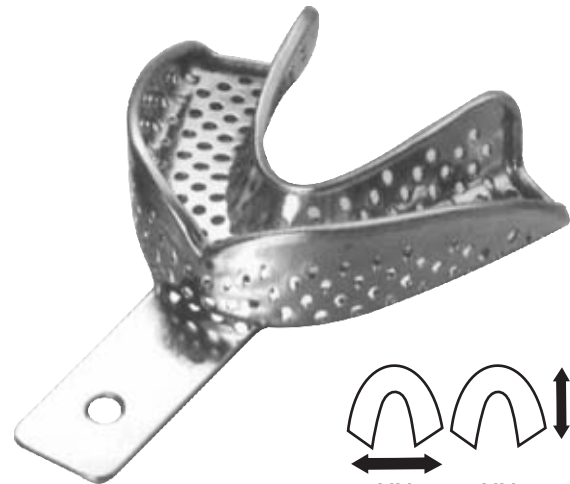

		MM	MM
UI37-031-L1	XXS	55	47
UI37-031-L2	XS	60	49
UI37-031-L3	S	72	54
UI37-031-L4	M	74	57
UI37-031-L5	L	76	59
UI37-031-L6	XL	78	61

Set of Twelve UI37-033-12

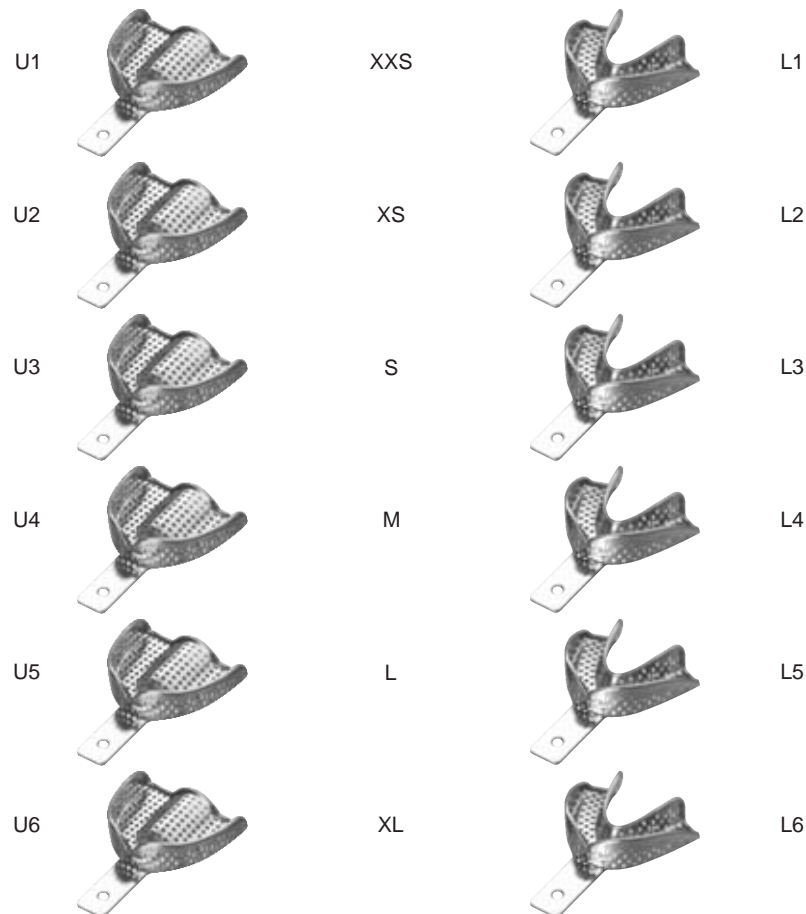

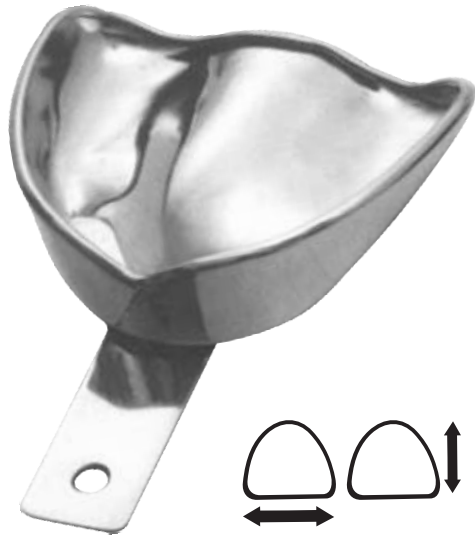
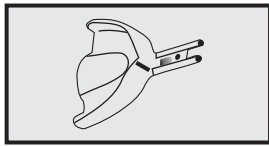

		MM	MM
UI37-035-U1	L	81	67
UI37-035-U4	M	71	64
UI37-035-U7	S	70	57



		MM	MM
UI37-037-L20	L	81	60
UI37-037-L21	M	79	57
UI37-037-L22	S	76	54

Set of Six UI37-039-06

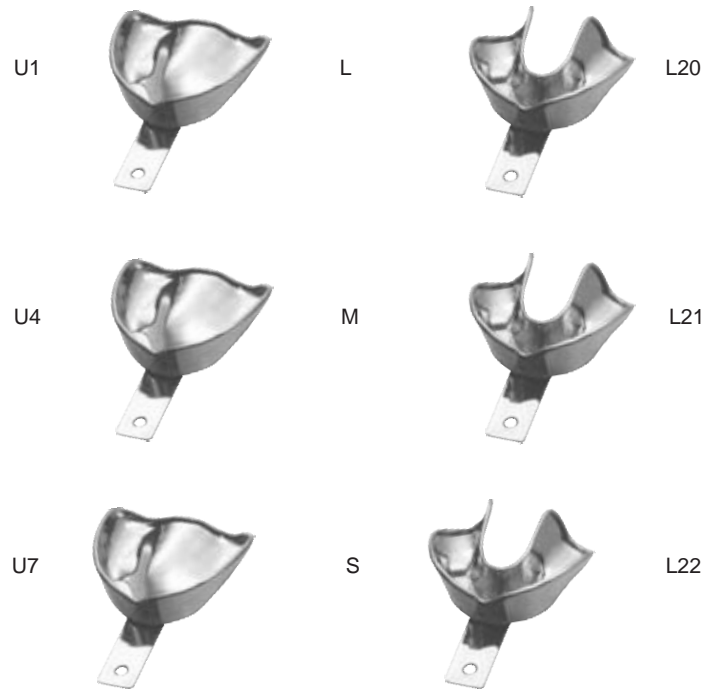

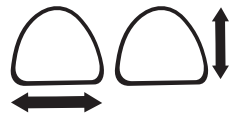
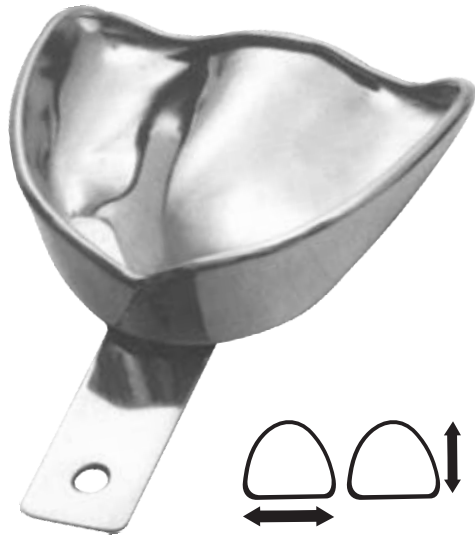
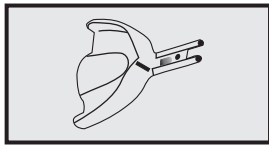

		MM	MM
UI37-041-U1	L	81	67
UI37-041-U4	M	71	64
UI37-041-U7	S	70	57

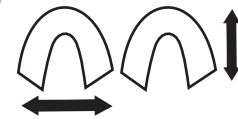

		MM	MM
UI37-043-L20	L	81	60
UI37-043-L21	M	79	57
UI37-043-L22	S	76	54

Set of Six UI37-045-06

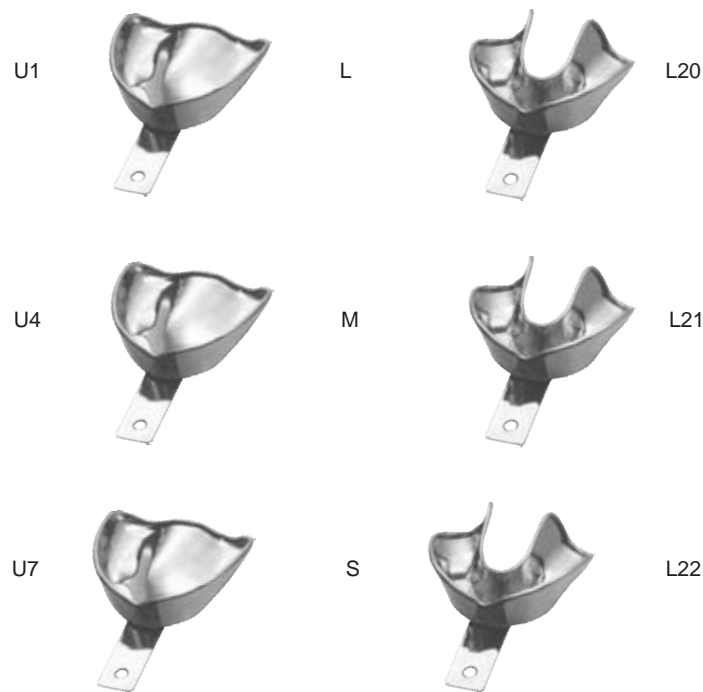

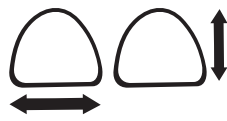
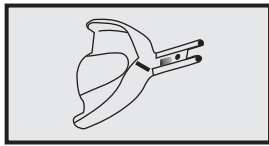

		MM	MM
UI37-047-U1	XL	73	62
UI37-047-U2	L	71	60
UI37-047-U3	M	69	57
UI37-047-U4	S	66	53
UI37-047-U5	XS	64	51
UI37-047-U6	XXS	61	47

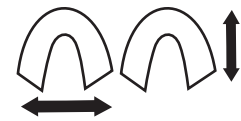

		MM	MM
UI37-049-L1	XL	78	61
UI37-049-L2	L	76	59
UI37-049-L3	M	75	57
UI37-049-L4	S	72	54
UI37-049-L5	XS	60	49
UI37-049-L6	XXS	55	47

Set of Ten UI37-051-12

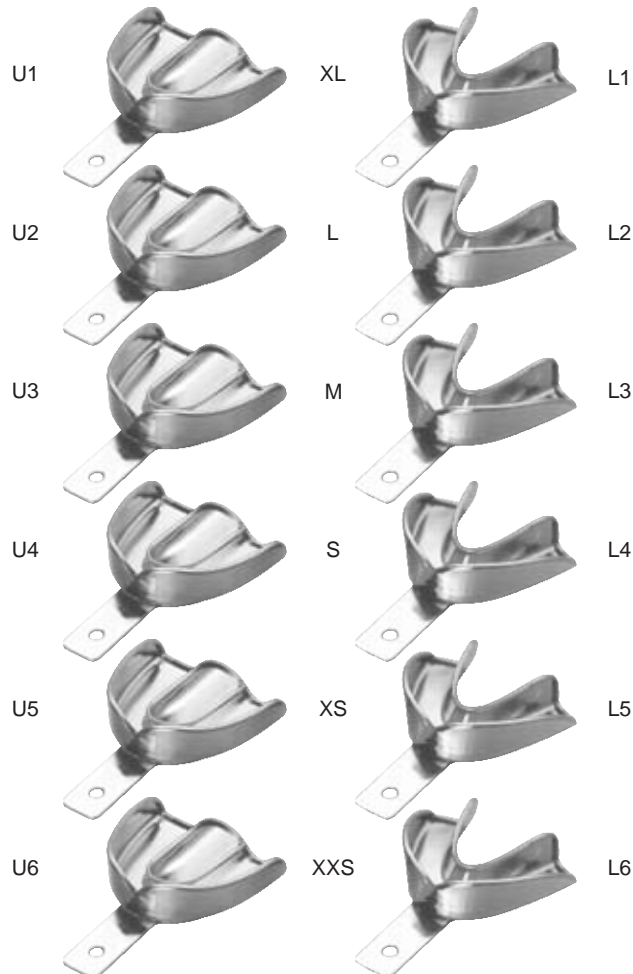

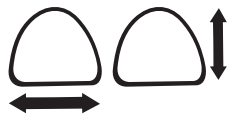
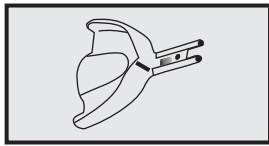

		MM	MM
UI37-053-U1	XL	81	63
UI37-053-U2	L	74	60
UI37-053-U3	M	71	55
UI37-053-U4	NM	67	53
UI37-053-U5	S	65	51

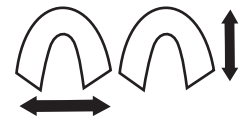

		MM	MM
UI37-055-L1	XL	80	63
UI37-055-L2	L	78	59
UI37-055-L3	M	76	57
UI37-055-L4	NM	72	57
UI37-055-L5	S	69	50

Set of Ten UI37-057-10

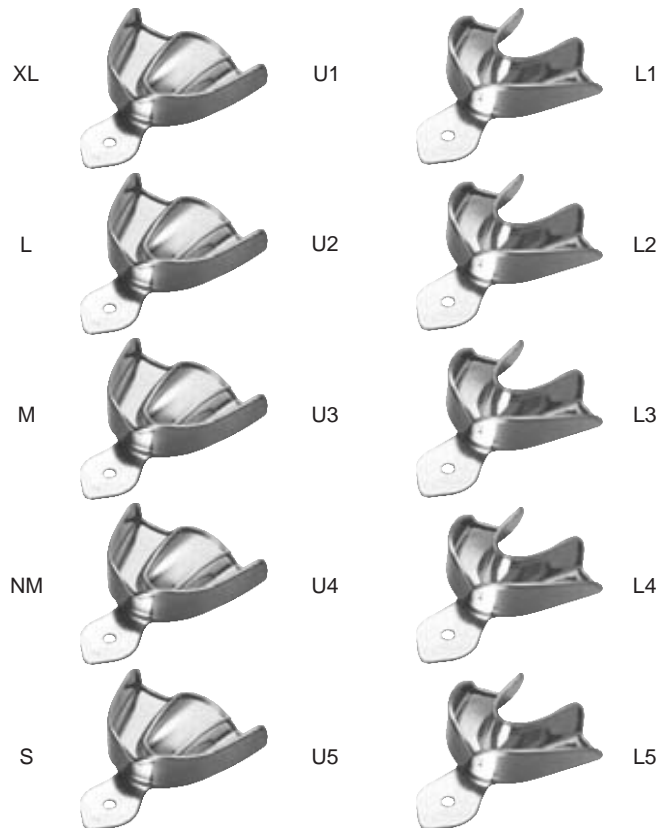

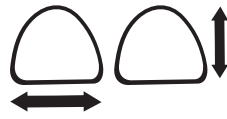
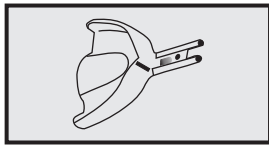

		MM	MM
UI37-059-U1	XL	68	62
UI37-059-U2	L	75	60
UI37-059-U3	M	73	53
UI37-059-U4	NM	69	54
UI37-059-U5	S	68	52

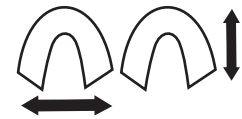

		MM	MM
UI37-061-L1	XL	82	63
UI37-061-L2	L	81	61
UI37-061-L3	M	78	57
UI37-061-L4	NM	74	60
UI37-061-L5	S	71	53

Set of Ten UI37-063-10

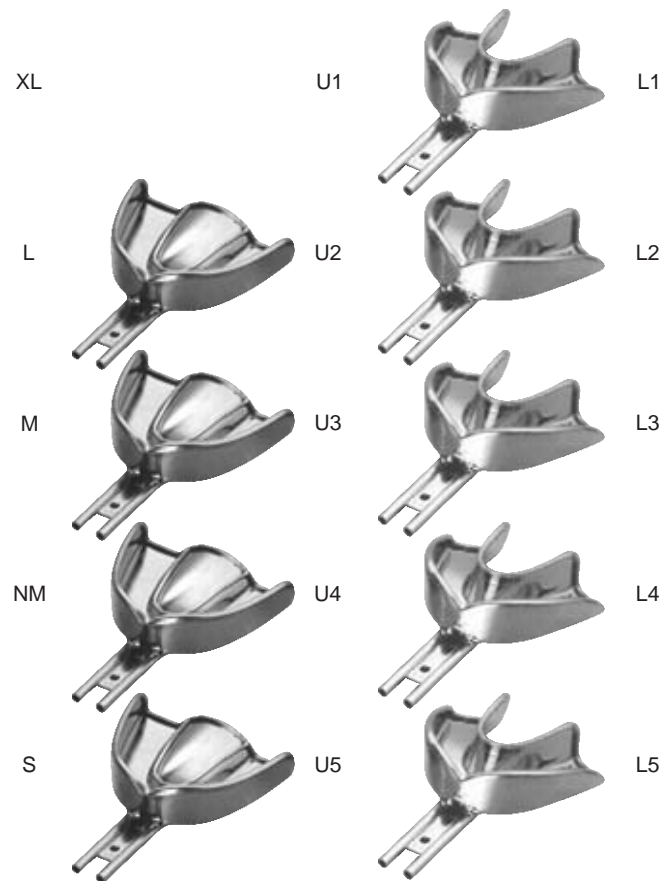

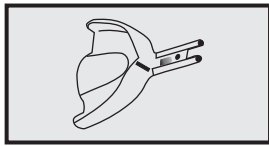

Form C 1/2 R

Form C 1/2 R

fig.	perforated	unperforated
1	UI37-065-01	UI37-067-11
2	UI37-065-02	UI37-067-12
3	UI37-065-03	UI37-067-13
4	UI37-065-04	UI37-067-14



Form C 1/2 L

Form C 1/2 L

1	UI37-069-01	UI37-071-11
2	UI37-069-02	UI37-071-12
3	UI37-069-03	UI37-071-13
4	UI37-069-04	UI37-071-14

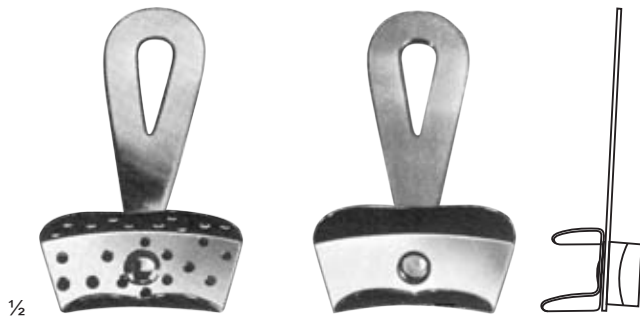

Universal
UI37-073-01

with swivel handle and fixing screw

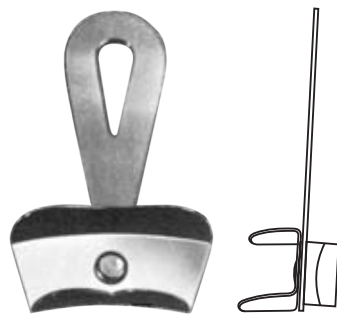

Universal
UI37-075-11



UI37-077-01

UI37-079-11

with swivel handle



Stolley
UI37-081-01

Stolley
UI37-083-11

with swivel handle and slide



Melotte
UI37-085-11

for crown work

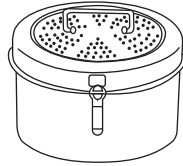

14

STERILIZING BOXES

 URIYA Instruments®



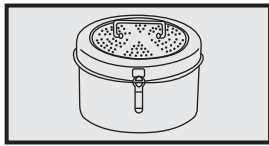

Ø mm	h mm	
80	80	UI38-001-01
120	120	UI38-001-02
160	120	UI38-001-03
160	150	UI38-001-04
190	140	UI38-001-05
190	200	UI38-001-06
240	120	UI38-001-07
240	160	UI38-001-08
240	240	UI38-001-09
290	120	UI38-001-10
290	160	UI38-001-11
290	240	UI38-001-12
340	160	UI38-001-13
340	240	UI38-001-14
390	145	UI38-001-15
390	200	UI38-001-16
390	290	UI38-001-17



135 mm x 100 x 25 mm
UI38-003-25



Proper
78 mmØx 63 mm
UI38-005-63



65 mmØ x 15 mm
UI38-007-15



150 mm x 95 X 13 mm
UI38-009-13



150 mm x 95 X 13 mm
UI38-011-13

UI38-001-01	UI38-001-17	Dressing Sterilizing Drum
	UI38-003-25	Case for Impression Trays
	UI38-005-63	Bur-Cleaning and Storing Box
	UI38-007-15	Needle Case
UI38-009-13	UI38-011-13	Boxes and Trays for Burs

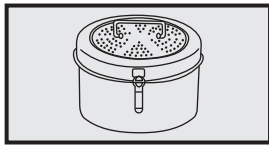

150 mm x 95 X 13 mm
UI38-013-13



150 mm x 95 X 13 mm
UI38-015-13



150 mm x 95 X 13 mm
UI38-017-13



UI38-019-13



∅ 110 X 27 mm UI38-021-27
∅ 110 x 40 mm UI38-023-40



150 mm x 95 X 13 mm
UI38-025-13



150 mm x 95 X 13 mm
UI38-027-13



∅ X h	Capacity	Satin Finish	Highly Polished
116 x 50	0.35	UI38-029-50	UI38-031-50
128 x 55	0.45	UI38-029-55	UI38-031-55
147 x 65	0.7	UI38-029-65	UI38-031-65
167 x 75	1.1	UI38-029-75	UI38-031-75
187 x 85	1.6	UI38-029-85	UI38-031-85



∅ X h	Capacity	Satin Finish	Highly Polished
116 x 35	0.3	UI38-033-35	UI38-035-35
128 x 38	0.4	UI38-033-38	UI38-035-38
147 x 40	0.5	UI38-033-40	UI38-035-40
167 x 45	0.75	UI38-033-45	UI38-035-45
187 x 45	1.0	UI38-033-54	UI38-035-54

UI38-013-13	UI38-027-13	Boxes and Trays for Burs
UI38-021-27	AE 21-023-40	Multipurpose Dish
UI38-029-50	UI38-035-54	Multipurpose Bowls

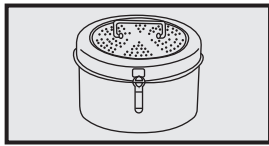

∅ x h	
110 x 128	UI38-037-12



∅	
100	UI38-039-10
120	UI38-039-12
150	UI38-039-15



100 cc
UI38-041-01



l x b x h	Satin Finish	Highly Polished
230 x 155 x 30	UI38-043-01	UI38-045-01
300 x 175 x 30	UI38-043-02	UI38-045-02
300 x 175 x 40	UI38-043-03	UI38-045-03
350 x 240 x 36	UI38-043-04	
400 x 300 x 50	UI38-043-05	



0.5L UI38-047-05
1.0L UI38-049-10
2.0L UI38-051-20



Dish + Lid	100 x 20 mm	UI38-053-01
Dish only	96 x 20 mm	UI38-055-09
Lid only	100 x 16 mm	UI38-057-10

Dish + Lid	100 x 20 mm	UI38-059-01
Dish only	96 x 20 mm	UI38-061-09
Lid only	100 x 16 mm	UI38-063-10



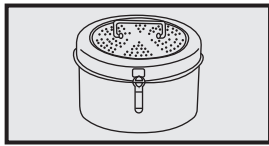

235 x 190 x 40 mm
UI38-065-40



Ø 220 x 70 mm
UI38-067-70



l x b x h	Satin Finish
210 x 160 x 10	UI38-069-01
240 x 180 x 10	UI38-069-02
310 x 150 x 10	UI38-069-03
310 x 210 x 10	UI38-069-04
350 x 240 x 10	UI38-069-05
350 x 240 x 20	UI38-069-06
400 x 270 x 20	UI38-069-07
420 x 280 x 10	UI38-069-08



Ø x h	Lid only	Jar without lid
30 x 90	UI38-071-01	UI38-073-01
50 x 100	UI38-071-02	UI38-073-02
50 x 130	UI38-071-03	UI38-073-03
50 x 175	UI38-071-04	UI38-073-04
75 x 100	UI38-071-05	UI38-073-05
75 x 130	UI38-071-06	UI38-073-06
75 x 175	UI38-071-07	UI38-073-07
100 x 175	UI38-071-08	UI38-073-08
100 x 200	UI38-071-09	UI38-073-09

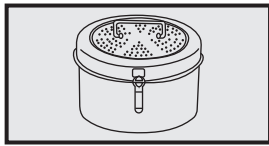

URIYA Instruments® Containers for Cotton Wool
Pallets etc.
Trays for Syringe Boxes



∅ x h	With lid without knob	Lid with knob
75 x 60	UI38-075-01	UI38-077-01
75 x 75	UI38-075-02	UI38-077-02
100 x 60	UI38-075-03	UI38-077-03
100 x 100	UI38-075-04	UI38-077-04
125 x 80	UI38-075-05	UI38-077-05
125 x 125	UI38-075-06	UI38-077-06
135 x 20	UI38-075-07	UI38-077-07
135 x 35	UI38-075-08	UI38-077-08
135 x 50	UI38-075-09	UI38-077-09
135 x 100	UI38-075-10	UI38-077-10
150 x 100	UI38-075-11	UI38-077-11
150 x 150	UI38-075-12	UI38-077-12
200 x 100	UI38-075-13	UI38-077-13
200 x 150	UI38-075-14	UI38-077-14
200 x 200	UI38-075-15	UI38-077-15



205 x 105 x 40 mm
UI38-079-40



20 cc
UI38-081-20
Medicine Cup



50 cc
UI38-083-50
Medicine Cup



25 cc
UI38-085-25
Medicine Cup



l x b x h	With lid without knob	Lid with knob
165 x 85 x 35	UI38-087-01	UI38-089-01
200 x 100 x 35	UI38-087-02	UI38-089-02
200 x 100 x 50	UI38-087-03	UI38-089-03
230 x 130 x 50	UI38-087-04	UI38-089-04
260 x 150 x 50	UI38-087-05	UI38-089-05
270 x 235 x 50	UI38-087-06	UI38-089-06
300 x 200 x 50	UI38-087-07	UI38-089-07
325 x 275 x 30	UI38-087-08	UI38-089-08

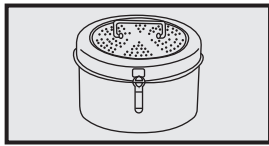

∅ 90 x 90 mm
UI38-091-90



∅ 75 x 50 mm
UI38-093-75



∅ 75 x 12 mm
UI38-095-75



250 x 115 x 15 mm
UI38-097-15



250 x 115 x 15 mm
UI38-099-25



250 x 115 x 15 mm
UI38-101-52

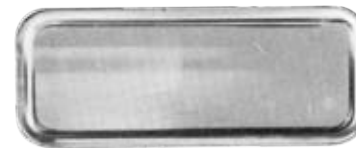
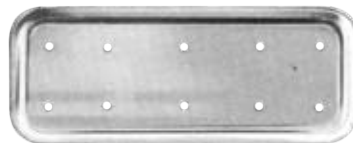

l x b x h	Perforated	Not Perforated
55 x 29 x 6	UI38-103-55	UI38-105-55
75 x 29 x 6	UI38-103-75	UI38-105-75
90 x 37 x 6	UI38-103-90	UI38-105-90

UI38-091-90	Tumblers
UI38-093-75	Container for Dentures
UI38-095-75	Trays for Tablets
UI38-097-15	Trays

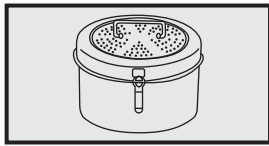

Ø 75 x 80 mm
UI38-107-75



Ø 75 x 80 mm
UI38-109-75



Method
Ø50 x 75 mm
UI38-111-50



Ø 75 x 90 mm UI38-113-75
100 x 30 mm UI38-113-10



Ø 75 x 90 mm
UI38-115-57



I x b x h	Lid only	Bowl only
170 x 100 x 35		UI38-119-35
250 x 140 x 40	UI38-117-40	UI38-119-40
275 x 150 x 45		UI38-119-45

UI38-107-75	UI38-109-75	Sputum Cups
	UI38-111-50	Cotton Wool Holders
UI38-113-75	UI38-113-10	Cotton Wool Dispenser
	UI38-115-57	Waste Receptacle
UI38-119-35	UI38-119-45	Instrument Tray, Kidney Shaped

PRF-BOX(Complete Box)



URIYA Instruments®

All kinds of Dental instruments .

WE ARE MANUFACTURERS AND EXPORTERS

Mobile # +61 402 764 684
+923126505109

Web : www.uriyainstruments.com
E-mail : uriyahinstruments@gmail.com
: info@uriyainstruments.com

